

2022

KESİCİ UÇ KATALOĞU  
INSERT CATALOGUE  
WENDESCHNEIDPLATTE KATALOG

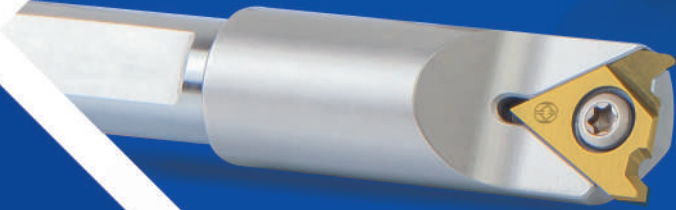
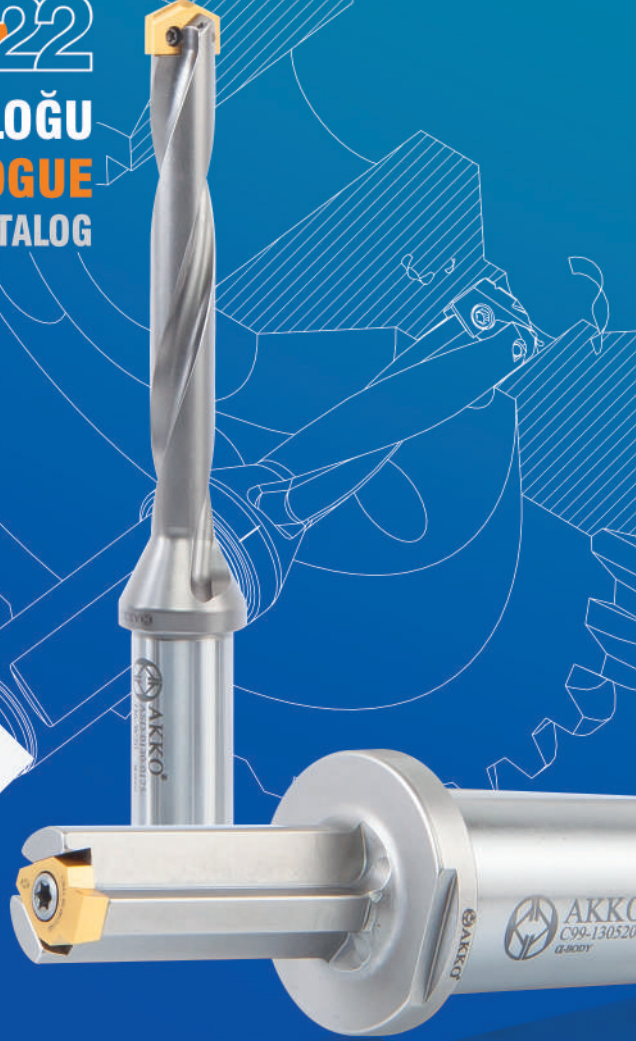
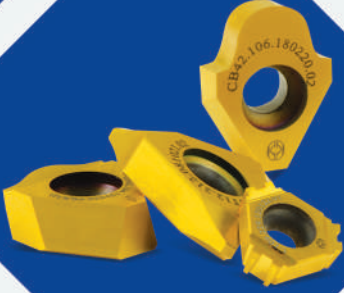

**AKKO**<sup>®</sup>

Kesici Uç ve Bağlama Sistemleri  
Cutting Inserts and Connection Systems  
Trägerwerkzeuge für Wendeschneidplatten

[www.akko.com.tr](http://www.akko.com.tr)



AKKO Metalworking Tools

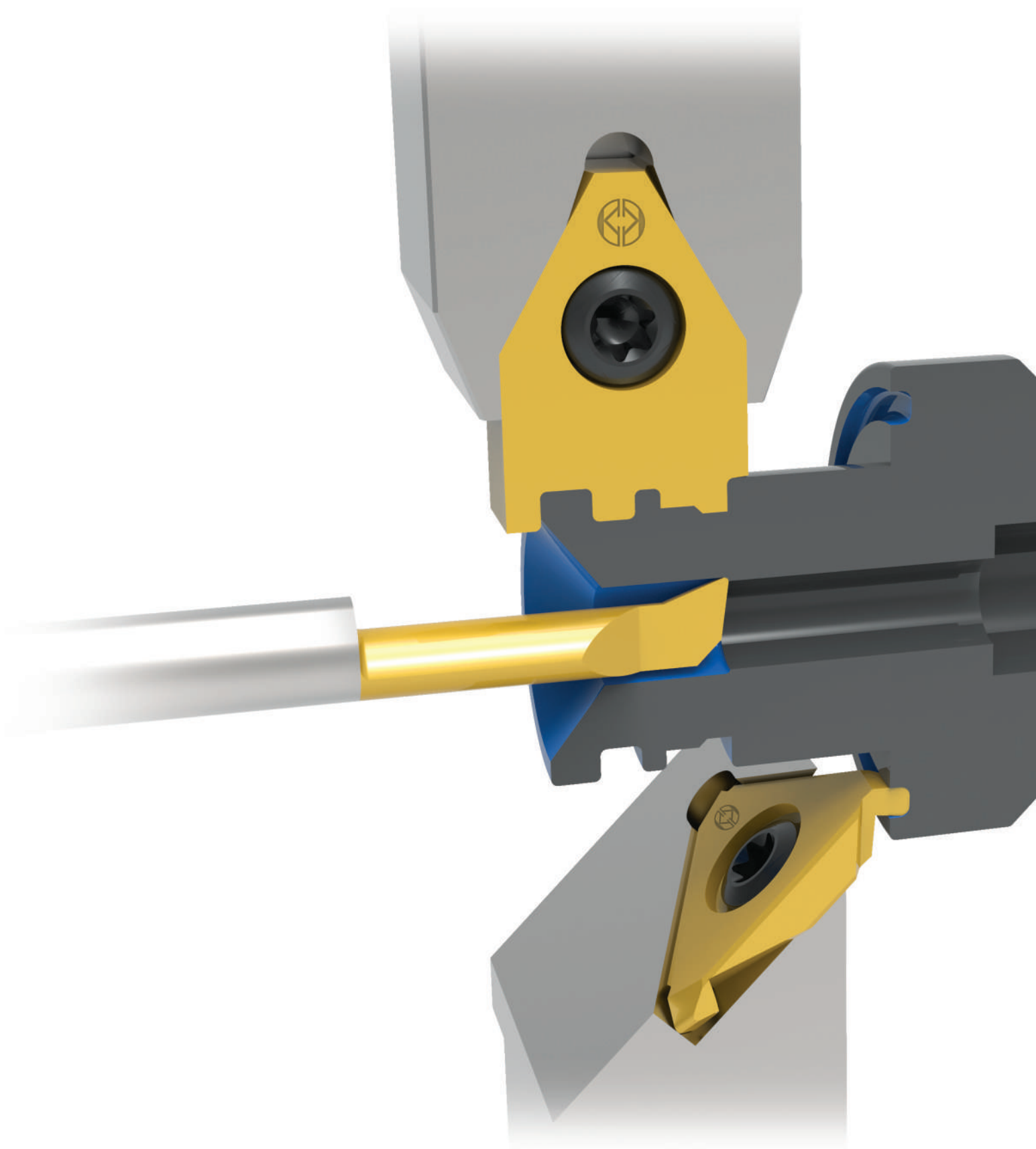

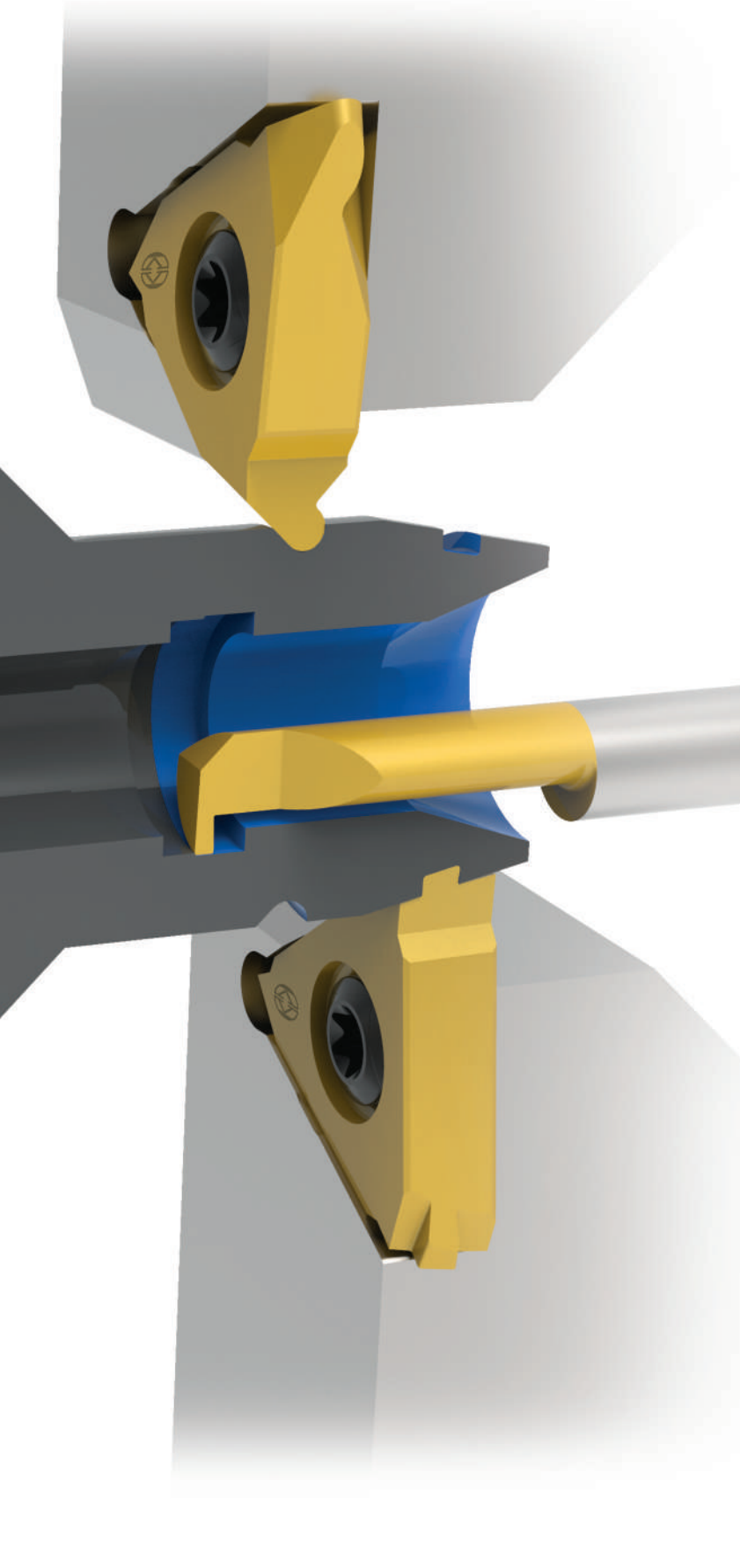

1986 yılında Abdullah KARAKUŞ tarafından kurulan AKKO Makina Sanayi ve Ticaret A.Ş. Tornalama Takımları, Diş ve Kanal Açma Takımları, Delik Delme Takımları, Frezeleme Takımları ve talebe yönelik Özel Takımları üretmektedir. Şu an 39.000 m<sup>2</sup>' ye yakın bir alanda Türkiye, Japonya, Almanya, İsviçre gibi ülkelerin ürettikleri son teknoloji tezgah ve ekipmanlarıyla yıllık 400.000 adet üretim kapasitesiyle, standart 10.000 çeşit takım üretimi yapmaktadır. Avrupa, Asya, Afrika, Güney Amerika, Kuzey Amerika ve Orta Doğu kıtalarında şimdilik 90 ülkeye ürün sevkiyatına devam etmektedir. Minimum 300.000 adet üretilmiş ürün stoklarında mevcut bulunmaktadır. Firma için özel üretilen çelik hammadde işleme girer ve bütün üretim süreci kendi bünyesinde gerçekleşmektedir. Çeliğin işlenmesi, ısıl işlemi, üzerindeki kaplama ve her türlü üretim operasyonları bir entegre tesis olan AKKO'da yapılmaktadır.

We as AKKO Makina Sanayi ve Ticaret A.Ş. which has been founded by Abdullah KARAKUŞ in 1986, produces Turning Tool Holders, Threading and Grooving Tool Holders, U-Drills, Milling Tool Holders, and Precision Tool Holders ( OEM Tool Holders ) on-demand. We produce standard 10.000 kinds of tool holders with a production capacity of 400.000 pieces per annum in an area of about 39.000 square meters. We are going on exporting to 90 countries including European, Asian, African, South American Countries, North American Countries, and Middle East Countries. We keep ready about 300.000 pieces produced products in our stock. Steel Raw materials that we make produced especially for us are delivered our factory and all production process are made in our factory. All kinds of operations from machining of steel to heat treatment and coating on our tools are made in our integrated factory AKKO.

Wir die Firma AKKO Makina Sanayi ve Ticaret A.Ş. welches durch Herrn Abdullah Karakuş in 1986 gegründet wurde, produzieren Dreh-, Gewinde- und Stechwerkzeuge für Wendeschneidplatten. Ebenso gehören Wendeplattenbohrer, Wendeplattenfräser und Sonderwerkzeuge nach Anfrage für Wendeplatten zum Lieferprogramm. Alle Werkzeuge sind auch als OEM-Version lieferbar. Wir produzieren 10.000 standart Arten der Werkzeughalter mit einer Produktionskapazität von 400.000 Stücken per annum auf einer Fläche von 39.000 quadrat meter. Wir exportieren unsere eigenproduzierten Ware nach 90 Ländern, Europa, Asien, Afrika, Süd amerikanische Länder, Mittlerer Osten. Lieferbereit halten wir 300.000 Stück produzierte Produkte auf Lager. Das eingesetzte Rohmaterial wird speziell für unsere Firma produziert. Alle Produktionsschritte werden auf unseren eigenen Anlagen veranlasst. Alle einzelnen Produktionsschritte wie z.B. mechanische Bearbeitung, Wärmebehandlung und Beschichtung unserer Werkzeuge erfolgen auf unseren eigenen Maschinenanlagen.

S8-S11 S8-S11 S8-S11	<b>POLY-V KAYIS KASNAK KANAL AÇMA UÇLARI VE TAKIMLARI</b> TEK KANALLI POLY-V UÇLARI VE TAKIMLARI ÇİFT KANALLI POLY-V UÇLARI VE TAKIMLARI ÇOK KANALLI POLY-V UÇLARI VE TAKIMLARI
----------------------------	--

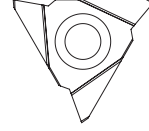

S12-S15 S12-S15 S12-S15	<b>KANAL AÇMA, YÜZEY KANAL AÇMA UÇLARI VE TAKIMLARI</b> YÜZEY KANAL AÇMA UÇLARI VE TAKIMLARI RADYUSLU KÖŞE BOŞALTMA UÇLARI VE TAKIMLARI ÖZEL KANAL UCU BİLGİ ALMA FORMU
-------------------------------	--

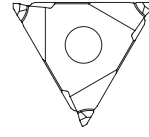

S16-S19 S16-S19 S16-S19 S16-S19 S16-S19	<b>BROŞ ÇEKME (KAMA) UÇLARI VE TAKIMLARI</b> BROŞ ÇEKME TAKIMLARI BROŞ ÇEKME (KAMA) UÇLARI (DIN138) (C11 TOLERANS) BROŞ (KAMA) UÇLARI (DIN6885) (P9 TOLERANS) KAMA KANALI PAH KIRMA UÇLARI ÖZEL PROFİL BROŞ UCU BİLGİ ALMA FORMU
---	---

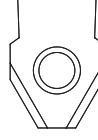

S26-S29 S26-S29 S26-S29 S26-S29 S26-S29 S26-S29	<b>WHIRLING UÇLARI VE TAKIMLARI</b> WHIRLING TAKIMLARI (RING) WHIRLING UÇLAR (ISO 5835) WHIRLING UÇLAR (ISO 9268) WHIRLING UÇLAR (ISO 9268) WHIRLING UÇLAR (METRİK DIN 13) WHIRLING UÇLAR BİLGİ ALMA FORMU
--	--

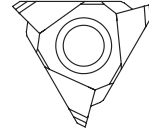

S31 S32-S40 S41 S42 S43	<b>MINI CUT TAKIMLAR</b> DELİK İÇİ MINI CUT TAKIMLAR KANAL AÇMA MINI CUT TAKIMLAR DIŞ ÇEKME MINI CUT TAKIMLAR ALIN KANALI AÇMA TAKIMLARI ÖZEL PROFİL MINI CUT TAKIMLAR BİLGİ ALMA FORMU
-------------------------------------	--

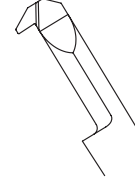

S45 S46 S47 S47	<b>TORX – ALYAN / PUNCH - KAZIMA TAKIMLARI</b> TORX PUNCH TAKIMLARI ALYAN PUNCH TAKIMLARI TORX KAZIMA TAKIMLARI ALYAN KAZIMA TAKIMLARI
--------------------------	--

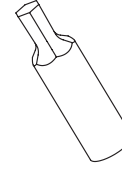

S48	<b>S-DRILL TAKMA UÇLU MATKAP TAKIMLARI VE UÇLARI</b> S-DRILL UÇLAR
-----	---



S50-S51 S52 S53	<b>DIŞ AÇMA FREZELEME TAKIMLARI VE UÇLARI</b> DIŞ AÇMA FREZELEME TAKIMLARI C14-C21 DIŞ TARAĞI UÇLARI DIŞ UCU ÖZEL PROFİL BİLGİ ALMA FORMU
-----------------------	--

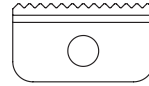

S55 S56 S57	<b>SEGMAN UÇLARI VE TAKIMLARI</b> SEGMAN TAKIMLARI SEGMAN UÇLARI (DIN471) ÖZEL PROFİL SEGMAN UÇLARI BİLGİ ALMA FORMU
-------------------	---

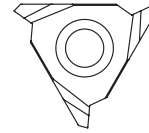

#### ÖZEL ÇÖZÜMLER

S67-S68 S68-S70 S70 S71	<b>SUPAP YUVASI İŞLEME UÇLARI VE TAKIMLARI</b> SUPAP YUVASI İŞLEME TAKIMLARI SUPAP YUVASI İŞLEME UÇLARI SUPAP YUVASI İŞLEME ÖZEL UÇ BİLGİ ALMA FORMU PILOT MILLER
----------------------------------	---



S72-S91 S92-S99 S100-S102	<b>ISO UÇLAR</b> WCMX/SPMX UÇLAR KESME VE KANAL AÇMA UÇLARI AYARLANABİLİR BARA UÇLARI
---------------------------------	--



# İÇİNDEKİLER



# CONTENTS

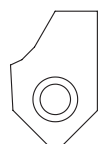
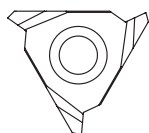
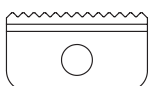
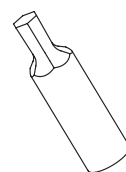
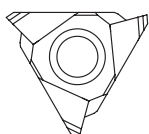
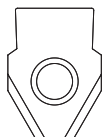
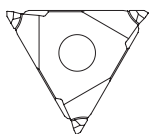
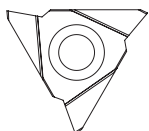

<b>POLY-V BELT PULLEY GROOVING INSERTS AND TOOLHOLDERS</b>	
INSERTS FOR GROOVING SINGLE V-RIBBED PULLEYS	P8-P11
INSERTS FOR GROOVING DOUBLE V-RIBBED PULLEYS	P8-P11
INSERTS FOR GROOVING MULTI V-RIBBED PULLEYS	P8-P11

<b>GROOVING, FACE GROOVING INSERTS AND TOOLHOLDERS</b>	
FACE GROOVING INSERTS AND TOOLHOLDERS	P12-P15
INSERTS AND TOOLHOLDERS FOR GROOVING CORNER RELIEFS WITH RADIUS	P12-P15
INFORMATION FORM FOR SPECIAL GROOVING INSERTS	P12-P15

<b>BROACHING (KEYWAY) INSERTS AND TOOLHOLDERS</b>	
BROACHING TOOLHOLDERS	P16-P19
BROACHING (KEYWAY) INSERTS (DIN138) (TOLERANCE C11)	P16-P19
BROACHING (KEYWAY) INSERTS (DIN6885) (TOLERANCE P9)	P16-P19
INSERTS FOR KEYWAY CHAMFERING	P16-P19
INFORMATION FORM FOR SPECIAL PROFILE BROACHING INSERTS	P16-P19

<b>WHIRLING INSERTS AND TOOLHOLDERS</b>	
WHIRLING TOOLHOLDERS (RING)	P26-P29
WHIRLING INSERTS (ISO 5835)	P26-P29
WHIRLING INSERTS (ISO 9268)	P26-P29
WHIRLING INSERTS (ISO 9268)	P26-P29
WHIRLING INSERTS (METRIC DIN 13)	P26-P29
INFORMATION FORM FOR WHIRLING INSERTS	P26-P29

<b>MINI CUT TOOLS</b>	
INTERNAL MINI CUT TOOLS	P31
GROOVING MINI CUT TOOLS	P32-P40
THREADING MINI CUT TOOLS	P41
MINI CUT FACE GROOVING TOOLS	P42
INFORMATION FORM FOR SPECIAL PROFILE MINI CUT TOOLS	P43

<b>TORX - ALLEN / PUNCH - BROACH SET</b>	
TORX PUNCH	P45
ALLEN PUNCH	P46
TORX BROACH	P47
ALLEN BROACH	P47

<b>INDEXABLE S-DRILLS AND INSERTS</b>	
INDEXABLE S-DRILL INSERTS	P48

<b>THREAD MILLING TOOLHOLDERS AND INSERTS</b>	
THREAD MILLING TOOLHOLDERS AND INSERTS	P50-P51
C14-C21 THREAD PITCH GAUGE INSERTS	P52
INFORMATION FORM FOR SPECIAL PROFILE THREADING INSERT	P53

<b>RING INSERTS AND TOOLHOLDERS</b>	
RING TOOLHOLDERS	P55
RING INSERTS (DIN471)	P56
SPECIAL PROFILE RING INSERTS INFORMATION FORM	P57

## SPECIAL SOLUTIONS

<b>VALVE SEAT INSERTS AND TOOLHOLDERS</b>	
VALVE SEAT TOOLHOLDERS	P67-P68
VALVE SEAT INSERTS	P68-P70
INFORMATION FORM FOR VALVE SEAT INSERTS	P70
CARBIDE PILOT FOR VALVE SEAT	P71

<b>ISO INSERTS</b>	
WCMX-SPMX INSERTS	P72-P91
GROOVING & PARTING INSERT	P92-P99
ADJUSTABLE BORING INSERT	P100-P102

P8-P11	<b>WENDESCHNEIDPLATTEN UND WERKZEUGE FÜR POLY-V RIEMENSCHLEIBEN</b>
P8-P11	WENDESCHNEIDPLATTEN UND WERKZEUGE ZUM NUTEN VON KEILRIPPENSCHLEIBEN
P8-P11	WENDESCHNEIDPLATTEN UND WERKZEUGE ZUM NUTEN VON DUAL KEILRIPPENSCHLEIBEN
P8-P11	WENDESCHNEIDPLATTEN UND WERKZEUGE ZUM NUTEN VON MULTI KEILRIPPENSCHLEIBEN

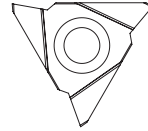

P12-P15	<b>WENDESCHNEIDPLATTEN UND WERKZEUGE FÜR NUTEN UND OBERFLÄCHENNUTEN</b>
P12-P15	WENDESCHNEIDPLATTEN UND WERKZEUGE FÜR OBERFLÄCHENNUTEN
P12-P15	WENDESCHNEIDPLATTEN UND WERKZEUGE FÜR AXIAL FREISTICHE
P12-P15	INFORMATIONSFÖRM FÜR SONDER WENDESCHNEIDPLATTEN

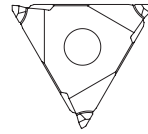

P16-P19	<b>WENDESCHNEIDPLATTEN UND WERKZEUGHALTER FÜR DIE NUTBEARBEITUNG</b>
P16-P19	WERKZEUGHALTER FÜR DIE NUTBEARBEITUNG
P16-P19	WENDESCHNEIDPLATTEN FÜR DIE NUTBEARBEITUNG
P16-P19	WENDESCHNEIDPLATTEN FÜR DIE NUTBEARBEITUNG (DIN6885) (P9 TOLERANZ)
P16-P19	WENDESCHNEIDPLATTEN FÜR KEILNUTUNGSBEARBEITUNGEN
P16-P19	INFORMATIONSFÖRMULAR FÜR SONDER WENDESCHNEIDPLATTEN ZURNUTUNGSBEARBEITUNGEN

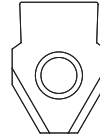

P26-P29	<b>WENDESCHNEIDPLATTEN UND WERKZEUGHALTER ZUM GEWINDEWIRBELN</b>
P26-P29	GEWINDEWIRBEL (RING)
P26-P29	GEWINDEWIRBEL FÜR (ISO 5835)
P26-P29	GEWINDEWIRBEL FÜR (ISO 9268)
P26-P29	GEWINDEWIRBEL FÜR (ISO 9268)
P26-P29	GEWINDEWIRBEL FÜR (METRIK DIN 13)
P26-P29	INFORMATIONSFÖRMULAR FÜR GEWINDEWIRBEL

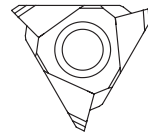

P31	<b>MINI CUT WERKZEUGE</b>
P32-P40	MINI CUT WERKZEUGE FÜR INNENBOHRUNG
P41	MINI CUT WERKZEUGE FÜR NUTEN
P42	GEWINDE MINI CUT WERKZEUGE
P43	WENDESCHNEIDPLATTEN
P43	INFORMATIONSFÖRMULAR FÜR SONDERPROFIL MINI CUT WERKZEUGE

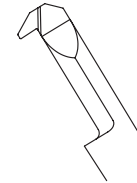

P45	<b>WINKELSCHRAUBENDREHER / EINSATZRING SET</b>
P46	TORX STANZWERKZEUGE
P47	WINKELSCHRAUBENDREHER WERKZEUGE
P47	SCHRAUBENRING
P47	WINKELSCHRAUBENDREHERRING

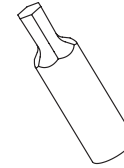

P48	<b>S-SYSTEM VOLLBOHRER/BEZEICHNUNGSSYSTEM FÜR VOLLBOHRER</b>
P48	S-SYSTEM BOHRSPITZEN

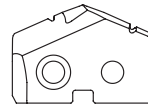

P50-P51	<b>GEWINDEFÄSSERWERKZEUGE</b>
P52	GEWINDEFÄSSERWERKZEUGE
P53	WENDESCHNEIDPLATTEN FÜR C14-C21 GEWINDESTEIFUNG
P53	INFORMATIONSFÖRMULAR FÜR SONDER GEWINDEPLATTEN

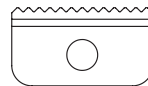

P55	<b>RINGPLATTEN UND WERKZEUGE</b>
P56	RINGPLATTEN WERKZEUGE
P57	RINGPLATTEN (DIN471)
P57	INFORMATIONSFÖRMULAR FÜR SONDERRINGPLATTEN

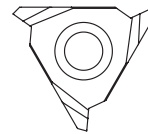

#### SONDERLÖSUNGEN

P67-P68	<b>WENDESCHNEIDPLATTEN UND WERKZEUGE FÜR VENTILSITZE</b>
P68-P70	WENDESCHNEIDPLATTEN FÜR VENTILSITZE
P70	BOHRUNGSSPITZEN FÜR VENTILSITZ BEARBEITUNG
P71	INFORMATIONSFÖRMULAR FÜR SONDER VENTILSITZ BEARBEITUNG
P71	METALLSCHAFT FÜR VENTILSITZ



P72-P91	<b>ISO WENDESCHNEIDPLATTE</b>
P92-P99	WCMX-SPMX WENDESCHNEIDPLATTE
P100-P102	AUSSTECH UND EINSTECHWENDESCHNEIDPLATTEN
P100-P102	EINSTELLBARE WENDESCHNEIDPLATTEN FÜR SPINDELKÖPF



# INHALTSVERZEICHNIS



***konusulan kalite...***  
***the spoken quality...***  
***qualität über die man spricht...***



# POLY-V

**KAYIŞ KASNAK KANAL AÇMA UÇLARI VE TAKIMLARI**  
*POLY-V BELT PULLEY GROOVING INSERTS AND TOOLHOLDERS*  
*WENDESCHNEIDPLATTEN UND WERKZEUGE FÜR*  
*POLY-V RIEMENSCHLEIBEN*





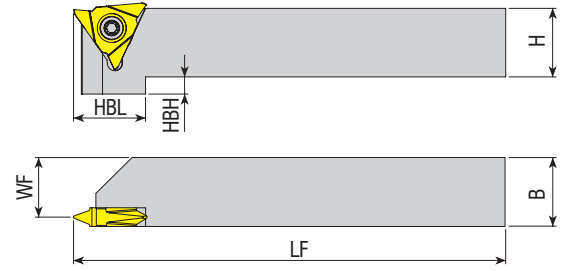

Takım Kodu Ordering Code Bestell-Bezeichnung	Stok Stock Lager		Takım Ölçüleri (mm) Dimension (mm) Abmessung (mm)					Kesici Uç Insert Wendeschnidplatte	Sıkma Vidası Screw Schraube	Tork Anahtar Torx Key Torx-Schlüssel	
	R	L	H	B	WF	LF	HBL	HBH			
ADKT-T12P-R/L-1616-T5	●	●	16	16	13.50	125	21	5	T12...	1020-M5x14	80-T20
ADKT-T12P-R/L-2020-T5	●	●	20	20	17.50	125	21	5			
ADKT-T12P-R/L-2525-T5	●	●	25	25	22.50	150	-	-			
ADKT-T12P-R/L-3232-T5	●	●	32	32	29.50	170	-	-			

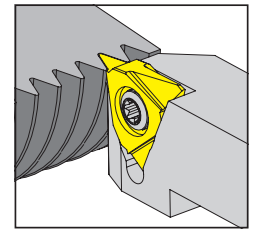
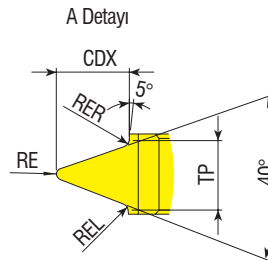
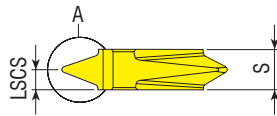
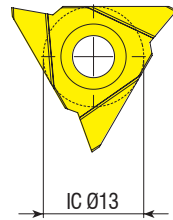
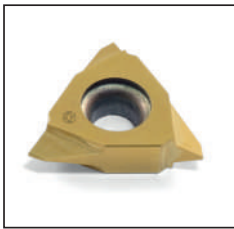

Uç Kodu Insert Code Wendeplatten-Bezeichnung	Stok Stock Lager		Uç Ölçüleri (mm) Insert Dimension (mm) Abmessung (mm)							Kalite Grade Sorte
	R	L	DIN/ISO KODU	TP	S	RE	RER / REL	LSCS	CDX	
T12.10.0234.PJ.R/L	●	●	PJ	2.34	5.20	0.36	0.24	2.60	2.08	VK20F01
T12.10.0356.PK.R/L	●	●	PK	3.56	5.20	0.44	0.35	2.60	3.40	VK20F01
T12.10.0470.PL.R/L	●	●	PL	4.70	5.20	0.36	0.45	2.60	4.90	VK20F01

R: Sağ / Right / Rechts L: Sol / Left / Links

● Stokta / In Stock / Auf Lager ○ Stokta Yok / Non Stock Item / Kein Lagerartikel, Lieferzeit auf Anfrage

ADKT-T12P... Tipi kâterler ile kullanınız. / Use with ADKT-T12P... Type toolholder. / Einsatz mit ADKT-T12P...-Werkzeughalter

İndekslediğinde boy  $\pm 0,02$ mm / Indexability length  $\pm 0,02$ mm / Wiederholgenauigkeit Länge  $\pm 0,02$  mm

Diğer ölçü talepleriniz için müşteri temsilciniz ile irtibata geçiniz. / For other dimension request, contact with customer representative. / Für weitere Abmessungen kontaktieren Sie bitte den Vertrieb.

Sipariş Örneği/Ordering Example/Bestellbeispiel

1 ad./pcs./stück ADKT-T12P-R-1616-T5

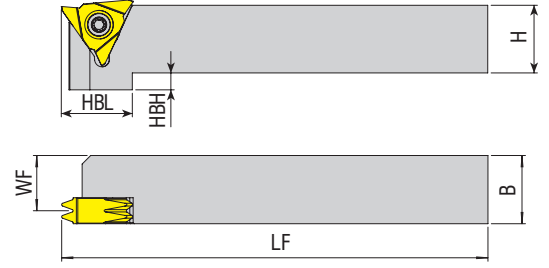

Takım Kodu Ordering Code Bestell-Bezeichnung	Stok Stock Lager		Takım Ölçüleri (mm) Dimension (mm) Abmessung (mm)					Kesici Uç Insert Wendeschnidplatte	Yedek Parçaları / Spare Parts / Ersatzteile		
	R	L	H	B	WF	LF	HBL		HBH	Sıkma Vidası Screw Schraube	Tork Anahtar Torx Key Torx-Schlüssel
ADKT-T30P-R-1616-3.56	●	●	16	16	12.2	125	20	5	T30...	1020x M4.5 X14	80-T20
ADKT-T30P-R-1616-2.34	●	●	16	16	12.2	125	20	5			
ADKT-T30P-R-2020-3.56	●	●	20	20	16.2	125	20	3			
ADKT-T30P-R-2020-2.34	●	●	20	20	16.2	125	20	3			
ADKT-T30P-R-2525-3.56	●	●	25	25	21.2	150	-	-			
ADKT-T30P-R-2525-2.34	●	●	25	25	21.2	150	-	-			
ADKT-T30P-R-3232-3.56	●	●	32	32	28.2	170	-	-			
ADKT-T30P-R-3232-2.34	●	●	32	32	28.2	170	-	-			

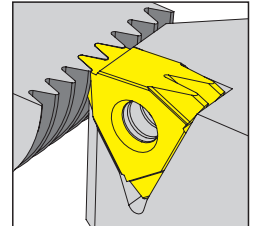
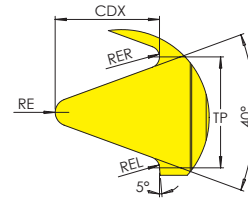
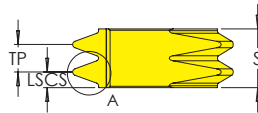
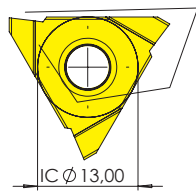

Uç Kodu Insert Code Wendeplatten-Bezeichnung	Stok Stock Lager	Uç Ölçüleri (mm) Insert Dimension (mm) Abmessung (mm)					Kalite Grade Sorte	
		DIN/ISO KODU	TP	S	RER/RE	LSCS		CDX
T30.07.0234.PJ.x2	●	PJ	2.34	7.60	0.24	2.60	2.08	VK20F01
T30.07.0356.PK.x2	●	PK	3.56	7.60	0.35	2.60	3.40	VK20F01

R: Sağ / Right / Rechts L: Sol / Left / Links

● Stokta / In Stock / Auf Lager ○ Stokta Yok / Non Stock Item / Kein Lagerartikel, Lieferzeit auf Anfrage

Sipariş Örneği/Ordering Example/Bestellbeispiel

1 ad./pcs./stück ADKT-T30P-R-1616-3.56

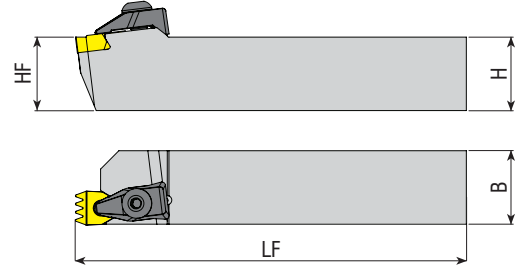

Takım Kodu Ordering Code Bestell-Bezeichnung	Stok Stock Lager		Takım Ölçüleri (mm) Dimension (mm) Abmessung (mm)			Kesici Uç Insert Wendeschneidplatte	Baskı Pabucu Wedge Clamp Spannpratze	Pabuç Vidası Clamp Screw Schraube	Anahtar Allen Key Innensechskantschlüssel
	R	L	HF=H	B	LF				
ATPVK 2020 K2.34X4	○	○	20	20	125	B26.07.0234PJ.x4	ATK-04	AKV-19-M7X25	AAL-05-4
ATPVK 2525 M2.34X4	○	○	25	25	150				
ATPVK 3232 P2.34X4	●	○	32	32	170				
ATPVK 2020 K3.56X4	○	○	20	20	125	B26.07.0356PK.x4	ATK-04	AKV-19-M7X25	AAL-05-4
ATPVK 2525 M3.56X4	○	○	25	25	150				
ATPVK 3232 P3.56X4	●	○	32	32	170				
ATPVK 2020 K4.7X3	○	○	20	20	125	B26.07.0470PL.x3	ATK-04	AKV-19-M7X25	AAL-05-4
ATPVK 2525 M4.7X3	○	○	25	25	150				
ATPVK 3232 P4.7X3	●	○	32	32	170				

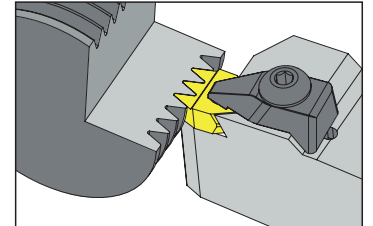
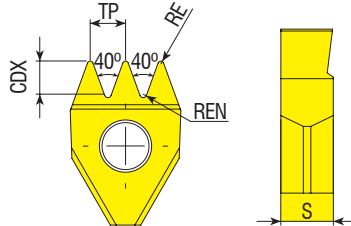
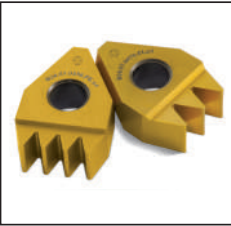

Uç Kodu Insert Code Wendepplatten-Bezeichnung	Stok Stock Lager	Uç Ölçüleri (mm) Insert Dimension (mm) Abmessung (mm)					Kalite Grade Sorte	
		DIN/ISO KODU	TP	S	RE	REN		CDX
B26.07.0234.PJx4	●	PJ	2.34	7	0.36	0.24	2.05	VK10F01
<b>new</b> B26.07.0356.PKx3	●	PK	3.56	7	0.45	0.35	3.35	VK10F01
B26.07.0356.PKx4	●	PK	3.56	7	0.45	0.35	3.35	VK10F01
B26.07.0470.PLx3	●	PL	4.70	7	0.38	0.45	4.85	VK10F01

R: Sağ / Right / Rechts L: Sol / Left / Links

● Stokta / In Stock / Auf Lager ○ Stokta Yok / Non Stock Item / Kein Lagerartikel, Lieferzeit auf Anfrage

Sipariş Örneği/Ordering Example/Bestellbeispiel

1 ad./pcs./stück ATPVK 2020 K2.34X4

# KANAL AÇMA

**KANAL AÇMA, KÖŞE BOŞALTMA UÇLARI ve TAKIMLARI**  
*INSERTS and TOOLHOLDERS FOR GROOVING CORNER RELIEFS*  
*WENDESCHNEIDPLATTEN UND WERKZEUGE FÜR*  
*AXIAL FREISTICHE*

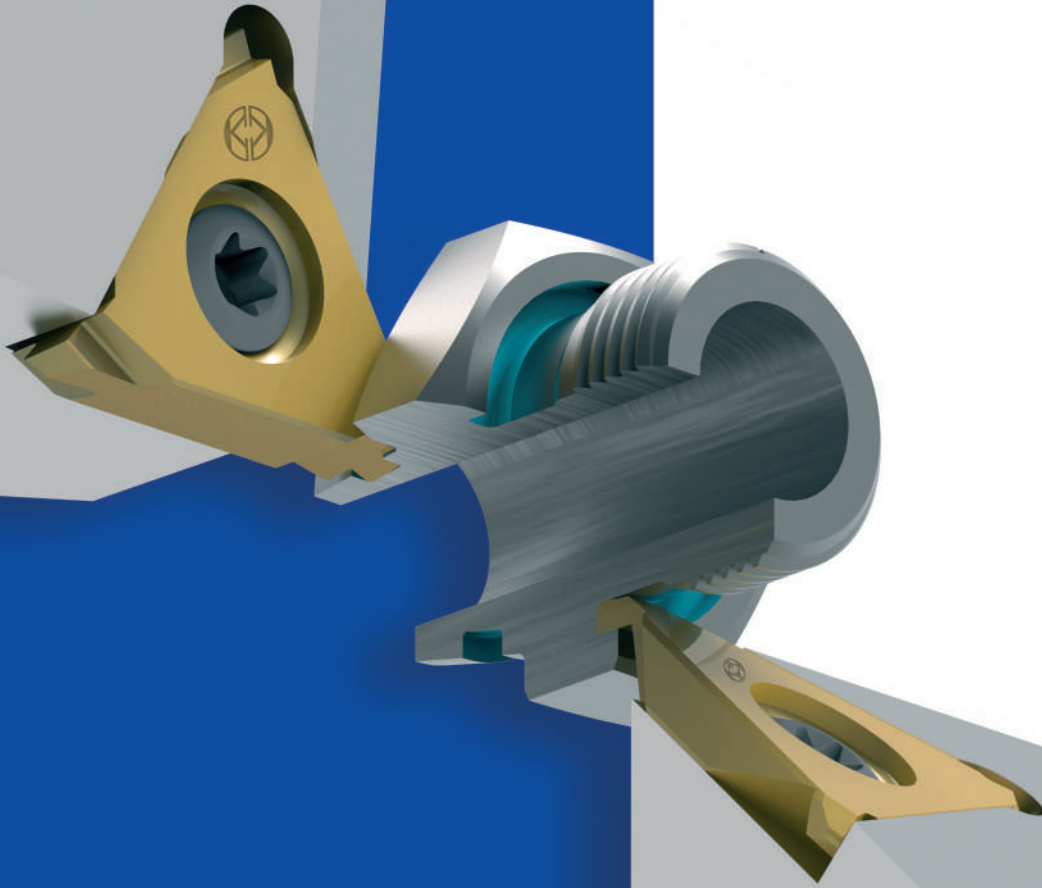



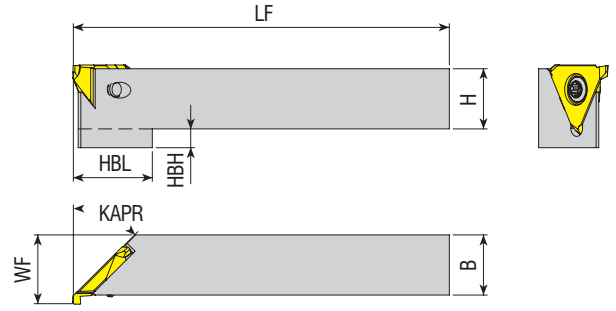
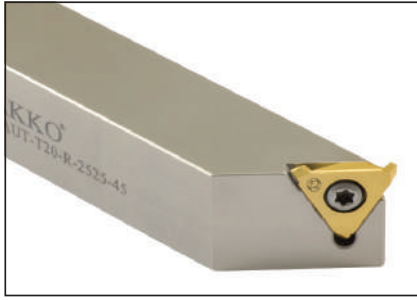

Takım Kodu Ordering Code Bestell-Bezeichnung	Stok Stock Lager		Takım Ölçüleri (mm) Dimension (mm) Abmessung (mm)						Kesici Uç Insert Wendescheidplatte	Yedek Parçaları / Spare Parts / Ersatzteile		
	R	L	H	B	WF	LF	HBL	HBH	KAPR	Sıkma Vidası Screw Schraube	Tork Anahtar Torx Key Torx-Schlüssel	
AAUT-T20-R/L-1616-45	●	●	16	16	18.3	125	21	5	45°			
AAUT-T20-R/L-2020-45	●	●	20	20	22.3	125	21	5	45°	T20...	1020-M5x7.5	80-T20
AAUT-T20-R/L-2525-45	●	●	25	25	27.3	150	-	-	45°			

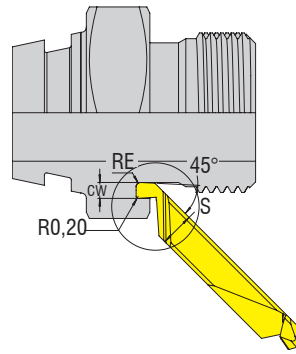
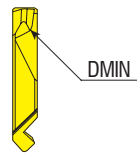
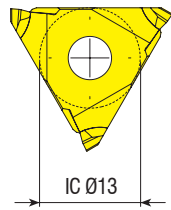
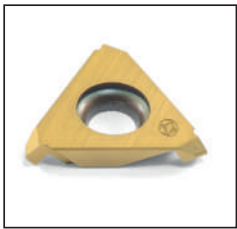

Sağ versiyon gösterilmiştir  
 Right hand version shown  
 Abbildung zeigt rechte Ausführung

Uç Kodu Insert Code Wendeplatten-Bezeichnung	Stok Stock Lager		Uç Ölçüleri (mm) Insert Dimension (mm) Abmessung (mm)					Kalite Grade Sorte	Minimum Çap Ø Minimum Diameter Ø Kleinster Durchmesser ø	Kanal Derinliği Depth of Groove Up to Stechtiefe bis zu	Kanal Genişliği Width of Groove Stechbreite
	R	L	CW	S	RE	CDX	DMIN				
T20.00.0815.45.04R/L	●	●	1.5	3.25	0.4	1.6	8	VK20F01	8	1.6	1.5
T20.00.1220.45.05R/L	●	●	2.0	3.25	0.5	1.8	12	VK20F01	12	1.8	2.0
T20.00.2024.45.06R/L	●	●	2.4	3.25	0.6	2.0	20	VK20F01	20	2.0	2.4

AAUT. Tipi katerlerle kullanınız. / Use with AAUT type toolholder. / Einsatz mit AAUT-Werkzeughalter  
 Kullanım öncesinde dip boşluk işlenmiş olmalıdır. / The undercut must be placed before axial machining. / Der Freistich muss vor der Axialbearbeitung gefertigt werden  
 İndekslenildiğinde boy ±0.02mm / Indexability length ±0.02mm / Wiederholgenauigkeit Länge ± 0,02 mm

Sipariş Örneği/Ordering Example/Bestellbeispiel  
 1 ad./pcs./stück AAUT-T20-R/L-1616-45

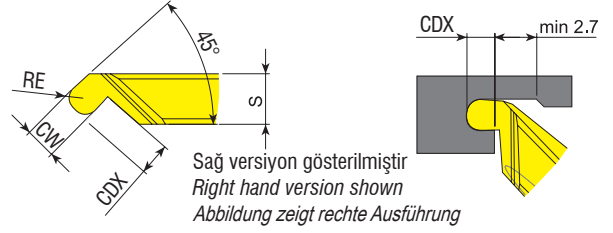
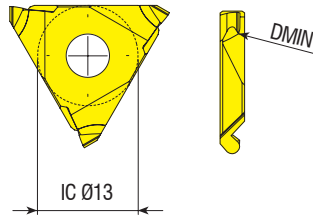
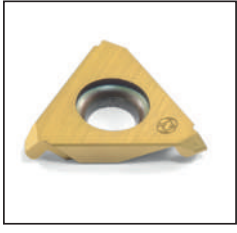

Uç Kodu  
 Insert Code  
 Wendeplatten-Bezeichnung

Stok  
 Stock  
 Lager

Uç Ölçüleri (mm)  
 Insert Dimension (mm)  
 Abmessung (mm)

Kalite  
 Grade  
 Sorte

Minimum Çap Ø  
 Minimum Diameter Ø  
 Kleinster Durchmesser ø

Kanal Derinliği  
 Depth of Groove Up to  
 Stechtiefe bis zu

Kanal Genişliği  
 Width of Groove  
 Stechbreite

T20.00.1220.45.10R/L

● ●

2.0

3.25

1.0

1.8

12

VK20F01

12

1.8

2

AAUT.. Tipi katerlerle kullanınız. / Use with AAUT type toolholder. / Einsatz mit AAUT-Werkzeughalter  
 Kullanım öncesinde dip boşluk işlenmiş olmalıdır. / The undercut must be placed before axial machining. / Der Freistich muss vor der Axialbearbeitung gefertigt werden  
 İndekslediğinde boy  $\pm 0.02$ mm / Indexability length  $\pm 0.02$ mm / Wiederholgenauigkeit Länge  $\pm 0,02$  mm

R: Sağ / Right / Rechts L: Sol / Left / Links

● Stokta / In Stock / Auf Lager ○ Stokta Yok / Non Stock Item / Kein Lagerartikel, Lieferzeit auf Anfrage

Sipariş Örneği/Ordering Example/Bestellbeispiel  
 1 ad./pcs./stück T20.00.1220.45.10R/L

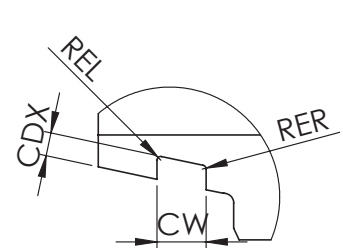
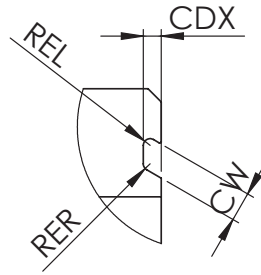
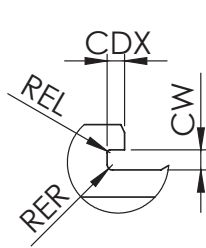
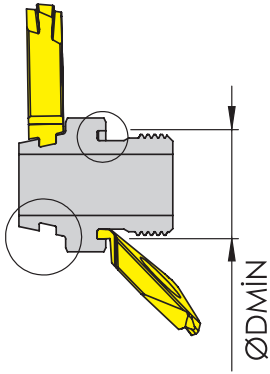

ÖZEL KANAL UCU BİLGİ ALMA FORMU  
 INFORMATION FORM FOR SPECIAL GROOVING INSERTS  
 INFORMATIONSFORM FÜR SONDER WENDESCHNEIDPLATTEN

CW	CDX	RER	REL	DMİN	İŞPARÇASI MALZEMESİ / WORKPIECE MATERIAL/ WERKSTÜCKMATERIAL

Farklı özel profilleri için lütfen irtibata geçiniz. / Please contact for different special profiles. / Bitte kontaktieren Sie uns für Sonderwendschneidplatten

export@akko.com.tr adresine teknik resim göndermeniz halinde iş parçanıza özel tasarımlar yapılabilir. / If you send a technical drawing to vexport@akko.com.tr special designs can be made for your workpiece. / Bei Einreichung von der technische Zeichnung an export@akko.com.tr können auch Werkzeug spezifische Entwürfe hergestellt werden.

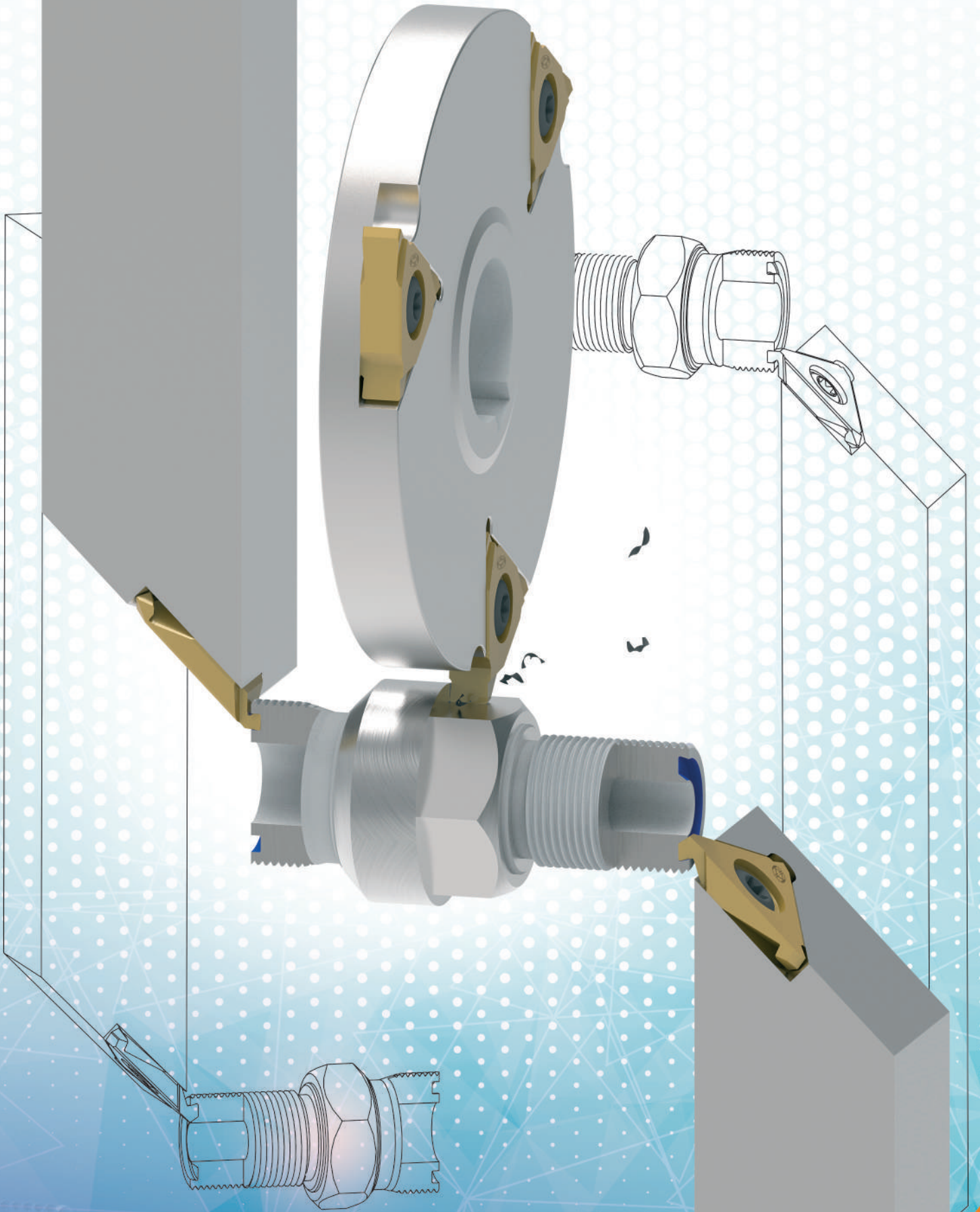

**KANAL AÇMA**  
**GROOVING**  
EINSTECHBOHRUNG



# BROŞ

**BROŞ ÇEKME UÇLARI ve TAKIMLARI**

*BROACHING INSERTS and TOOLHOLDERS*

*WENDESCHNEIDPLATTEN UND WERKZEUGHALTER FÜR  
DIE NUTBEARBEITUNG*

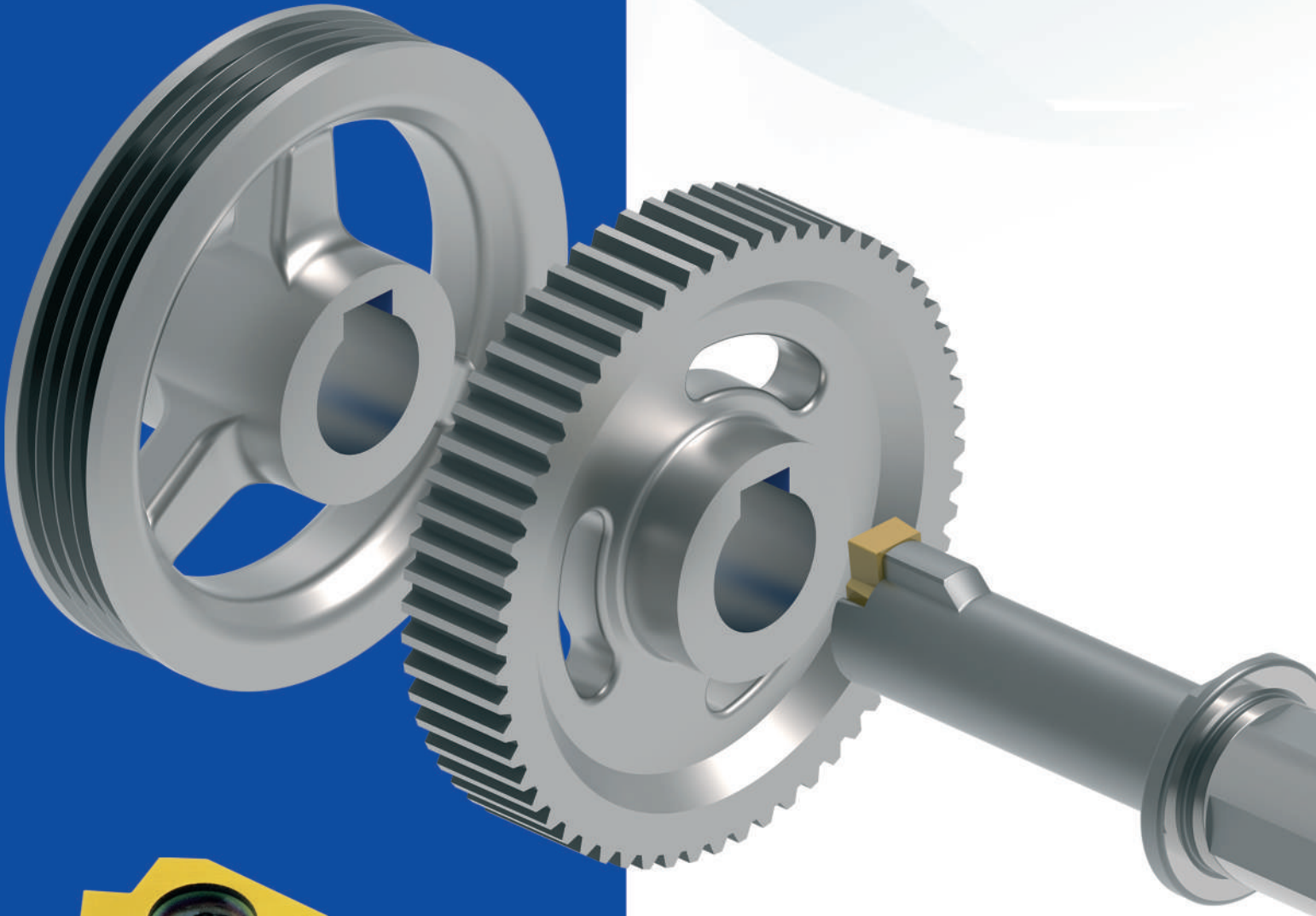



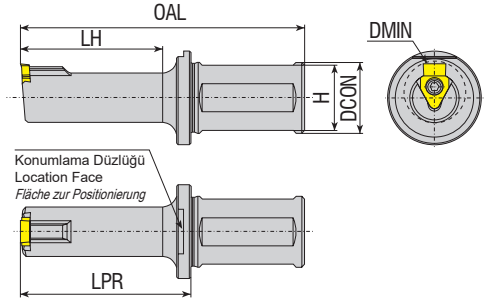

Takım Kodu Ordering Code Bestell-Bezeichnung	Stok Stock Lager	Takım Ölçüleri (mm) Dimension (mm) Abmessung (mm)						Kesici Uç Insert Wendeschneidplatte	Yedek Parçaları / Spare Parts / Ersatzteile	
		DMIN	LH	DCON	OAL	LPR	H		Sıkma Vidası Screw Schraube	Tork Anahtar Torx Key Torx-Schlüssel
ABT-B41-D17-Y25-L90-I040	●	17	40	25	90	50	23	B41...	4015-M4x11	80-T15
ABT-B41-D17-Y25-L105-I065	●	17	65	25	105	75	23			
ABT-B41-D22-Y25-L100-I050	●	22	50	25	100	60	23			
ABT-B41-D22-Y25-L125-I070	●	22	70	25	125	80	23			
ABT-B42-D30-Y32-L100-I050	●	30	50	32	100	60	30	B42...	1020-M5x14	80-T20
ABT-B42-D30-Y32-L125-I075	●	30	75	32	125	85	30			
ABT-B42-D30-Y32-L170-I110	●	30	110	32	170	120	30			
ABT-B42-D38-Y32-L100-I050	●	38	50	32	100	60	30			
ABT-B42-D38-Y32-L125-I075	●	38	75	32	125	85	30			
ABT-B42-D40-Y32-L100-I050	●	40	50	32	100	60	30			
ABT-B42-D40-Y32-L125-I075	●	40	75	32	125	85	30			

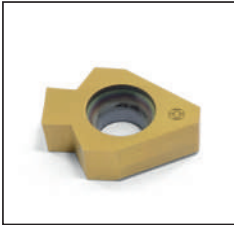

DIN138 (Tolerans C11) torna ve freze tezgahlarında broş çekme uçları.  
DIN138 (Tolerance C11) inserts for keyway broaching on lathe and milling machines.  
DIN 138 (Toleranz C11) Wendepfatten für Keilnutenfertigung auf Dreh- und Fräsmaschinen

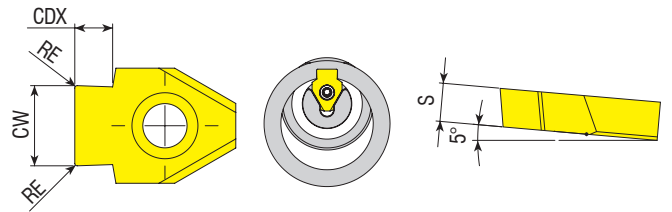

Uç Kodu Insert Code Wendepfatten-Bezeichnung	Stok Stock Lager	Uç Ölçüleri (mm) Insert Dimension (mm) Abmessung (mm)					UYUMLU TAKIM / COMPATIBLE TOOLHOLDER / KOMPATIBLES WERKZEUG
		CW	RE	CDX	S	DMIN	
B41.00.0612.085.VP3001	●	6.12	0.85	2.6	4.0	22	ABT-B41-D22...
B41.00.0713.085.VP3001	●	7.13	0.85	3.3	4.0	22	
B41.00.0813.105.VP3001	●	8.13	1.05	3.4	4.0	22	
B42.00.1013.105.VP3001	●	10.13	1.05	4.2	6.0	30	ABT-B42-D30...
B42.00.1215.135.VP3001	●	12.15	1.35	5.1	6.0	38	ABT-B42-D38...
B42.00.1215.175.VP3001	●	12.15	1.75	6.6	6.0	38	
B42.00.1215.225.VP3001	●	12.15	2.25	8.5	6.0	38	

Tipik kesme şartları / Typical cutting conditions Tipik kesme şartları / Typical cutting conditions / Standard-Schneidbedingungen: İlerleme (Vf): 3000-8000 mm/dak (min)  
/ Paso (ap): 0.02-0.08 mm / Vorschub (Vf): 3000-8000 mm/min

R: Sağ / Right / Rechts L: Sol / Left / Links

● Stokta / In Stock / Auf Lager ○ Stokta Yok / Non Stock Item / Kein Lagerartikel, Lieferzeit auf Anfrage

Sipariş Örneği/Ordering Example/Bestellbeispiel  
1 ad./pcs./stück ABT-B41-D17-Y25-L90-I040

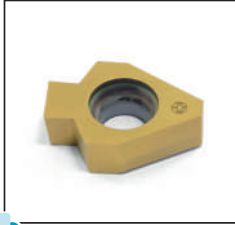

DIN6885 (Tolerans P9) torna ve freze tezgahlarında broş çekme uçları.  
DIN6885 (Tolerance P9) inserts for keyway broaching on lathe and milling machines.  
DIN6885 (Toleranz P9) Wendeplatten für Keilnutenfertigung auf Dreh- und Fräsmaschinen

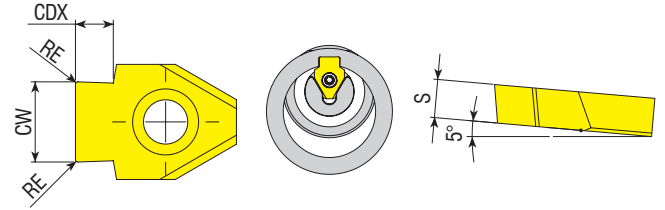

Uç Kodu Insert Code Wendeplatten-Bezeichnung/Idplatte	Stok Stock Lager	Uç Ölçüleri (mm) Insert Dimension (mm) Abmessung (mm)					UYUMLU TAKIM / COMPATIBLE TOOLHOLDER / KOMPATIBLES WERKZEUG
		CW	RE	CDX	S	DMIN	
B41.00.0498.020.VP3001	●	4.98	0.20	2.7	4.0	17	ABT-B41-D17
B41.00.0598.020.VP3001	●	5.98	0.20	3.4	4.0	17	
B41.00.0798.020.VP3001	●	7.98	0.20	4.1	4.0	22	ABT-B41-D22
B42.00.0998.030.VP3001	●	9.98	0.30	4.2	6.0	30	ABT-B42-D30
B42.00.1197.030.VP3001	●	11.97	0.30	5.7	6.0	38	ABT-B42-D38
B42.00.1397.030.VP3001	●	13.97	0.30	6.8	6.0	40	ABT-B42-D40

Tipik kesme şartları / Typical cutting conditions / Standard-Schneidbedingungen: İlerleme (Vf): 3000-8000 mm/dak (min) / Paso (ap): 0.02-0.08 mm / Vorschub (Vf): 3000-8000 mm/min

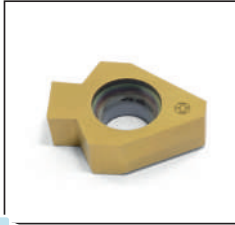

DIN6885 (Tolerans JS9) torna ve freze tezgahlarında broş çekme uçları.  
DIN6885 (Tolerance JS9) inserts for keyway broaching on lathe and milling machines.  
DIN6885 (Toleranz JS9) Wendeplatten für Keilnutenfertigung auf Dreh- und Fräsmaschinen

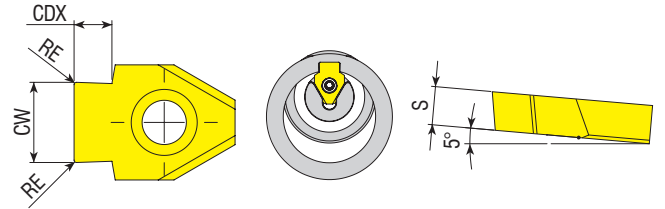

Uç Kodu Insert Code Wendeplatten-Bezeichnung/Idplatte	Stok Stock Lager	Uç Ölçüleri (mm) Insert Dimension (mm) Abmessung (mm)					UYUMLU TAKIM / COMPATIBLE TOOLHOLDER / KOMPATIBLES WERKZEUG
		CW	RE	CDX	S	DMIN	
B41.00.0501.020.VP3001	●	5.01	0.20	2.7	4.0	17	ABT-B41-D17
B41.00.0601.020.VP3001	●	6.01	0.20	3.4	4.0	17	
B41.00.0801.020.VP3001	●	8.01	0.20	4.1	4.0	22	ABT-B41-D22
B42.00.1001.030.VP3001	●	10.01	0.30	4.2	6.0	30	ABT-B42-D30
B42.00.1200.050.VP3001	●	12.00	0.50	8.5	6.0	38	ABT-B42-D38
B42.00.1201.030.VP3001	●	12.01	0.30	5.7	6.0	38	ABT-B42-D38
B42.00.1401.030.VP3001	●	14.01	0.30	6.8	6.0	40	ABT-B42-D40

Tipik kesme şartları / Typical cutting conditions / Standard-Schneidbedingungen: İlerleme (Vf): 3000-8000 mm/dak (min) / Paso (ap): 0.02-0.08 mm / Vorschub (Vf): 3000-8000 mm/min



Torna ve freze tezgahlarında kama kanalı pah kırma uçları.  
Inserts for keyway chamfering on lathe and milling machines.  
Wendeschnidplatten zum Anfasen von Keilnuten auf Dreh- und Fräsmaschinen

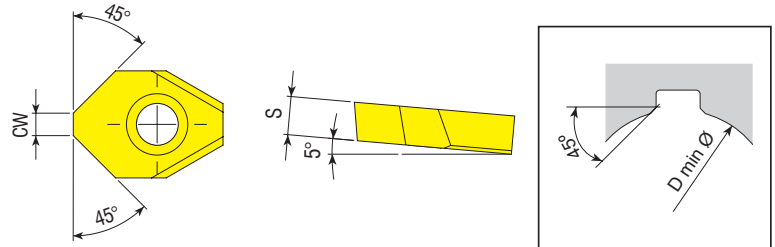

Uç Kodu Insert Code Wendeplatten-Bezeichnung/Idplatte	Stok Stock Lager	Uç Ölçüleri (mm) Insert Dimension (mm) Abmessung (mm)			UYUMLU TAKIM / COMPATIBLE TOOLHOLDER / KOMPATIBLES WERKZEUG
		DMIN	CW	S	
B41.00.0150.CH.VP3001	●	17	1.5	4.0	ABT-B41-D17
B41.00.0300.CH.VP3001	●	22	3.0	4.0	ABT-B41-D22
B42.00.0600.CH.VP3001	●	30	6.0	6.0	ABT-B42-D30

Tipik kesme şartları / Typical cutting conditions / Standard-Schneidbedingungen: İlerleme (Vf): 3000-8000 mm/dak (min) / Paso (ap): 0.02-0.08 mm / Vorschub (Vf): 3000-8000 mm/min

R: Sağ / Right / Rechts L: Sol / Left / Links

● Stokta / In Stock / Auf Lager ○ Stokta Yok / Non Stock Item / Kein Lagerartikel, Lieferzeit auf Anfrage

Sipariş Örneği/Ordering Example/Bestellbeispiel

1 ad./pcs./stück B41.00.0498.020.VP3001

PROFİL VERİLMİŞ UÇLAR / PROFILED INSERTS / PROFIL-WENDESCHNEIDPLATTEN  
ÖRNEK PROFİLLER / EXAMPLES OF PROFILES / BEISPIELE FÜR PROFILE



Profil uçlar müşterilerimizin özel taleplerine göre üretilmektedir.  
Profiled inserts are manufactured according to customer special requirements.  
Die Profil-Wendeschnidplatten werden nach Kundenwunsch gefertigt.



Üretmemizi istediğiniz Ucun teknik özelliklerini veya bir örneğini bize gönderin.  
Send us the technical specifications or a sample of the insert you want to produce.  
Bitte lassen Sie uns ein exemplar sowie die technischen Einzelheiten der gewünschten Wendeschnidplatte zukommen.



Sizin için bir teklif hazırlayalım.  
We prepare an offer for you.  
Wir werden für Sie ein Angebot vorbereiten.



Üretimi yapıp size gönderebiliriz.  
We produce it and ship it to you.  
Wir werden es produzieren und Ihnen ausliefern.

BROŞ UCU BİLGİ ALMA FORMU / BROACHING INSERT INFORMATION FORM / INFORMATIONSBLATT FÜR DIE WENDESCHNEIDPLATTE DER NUTBEARBEITUNG

Broş ve Delik Ölçüleri / Dimension of Bore / Maße von Bohrungsdurchmesser und Nuten

b			
t			
r			
d/min*			
İş Parçası Malzemesi Work Material Werkstückmaterial			
Tolerans Grubu / Tolerane Group / Toleranzgruppe			
C11	P9	JS9	CUSTOM

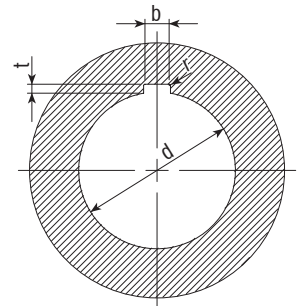



# TULIP HEADS

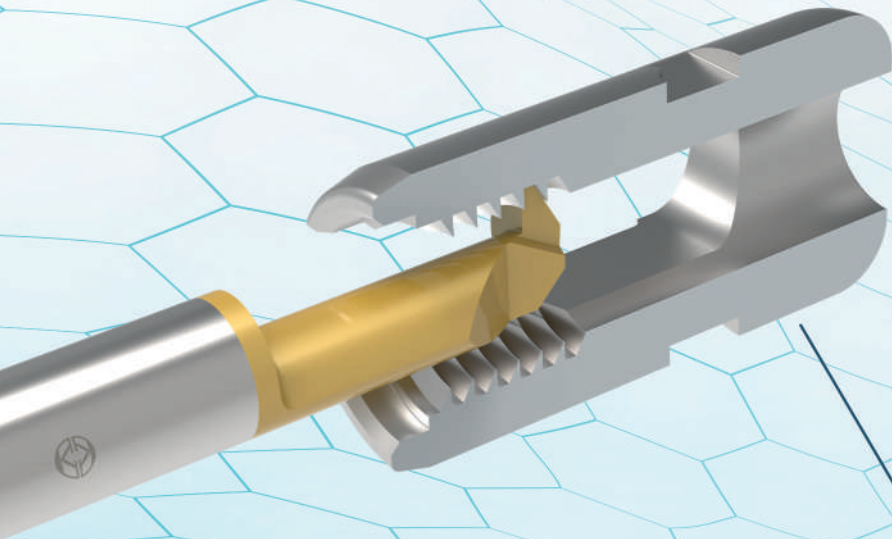
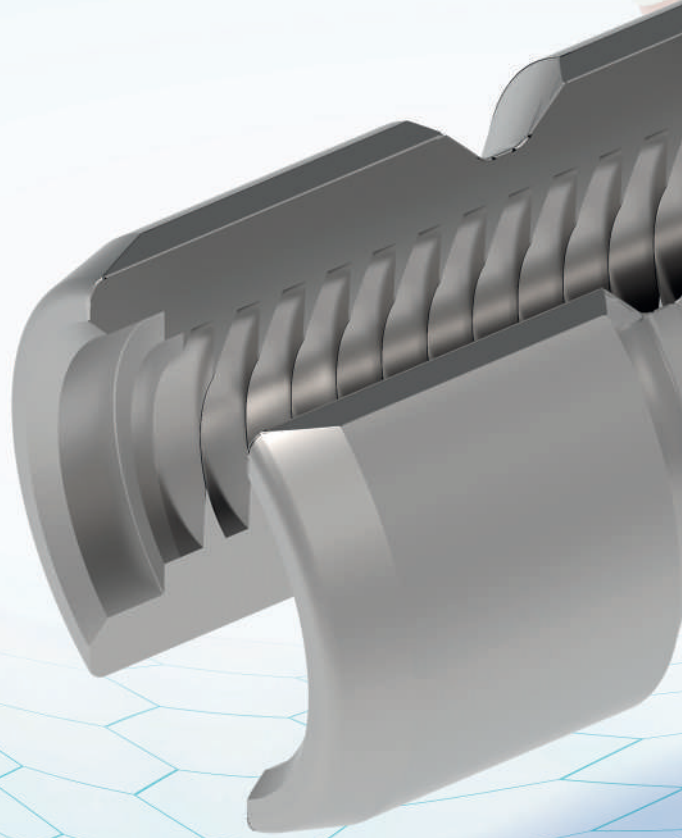
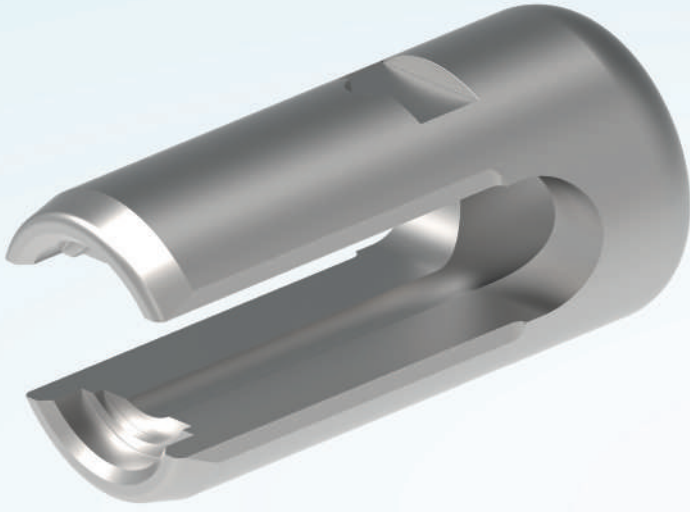

**DIŞ AÇMA**  
**THREADING**   
**GEWINDE**



DELİK İÇİ  
TORNALAMA

**BORING**  
*BOHREN*

ÖZEL FORMA AÇMA

**SPECIAL FORMING**  
*SONDER FORM BEARBEITUNG*

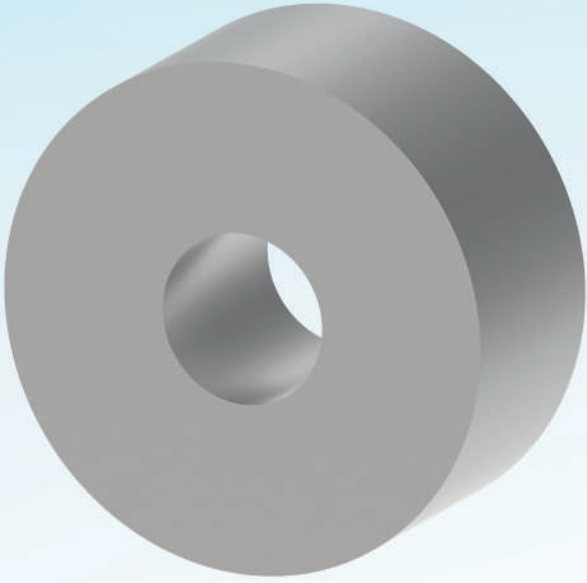

# IMPLANT NUT

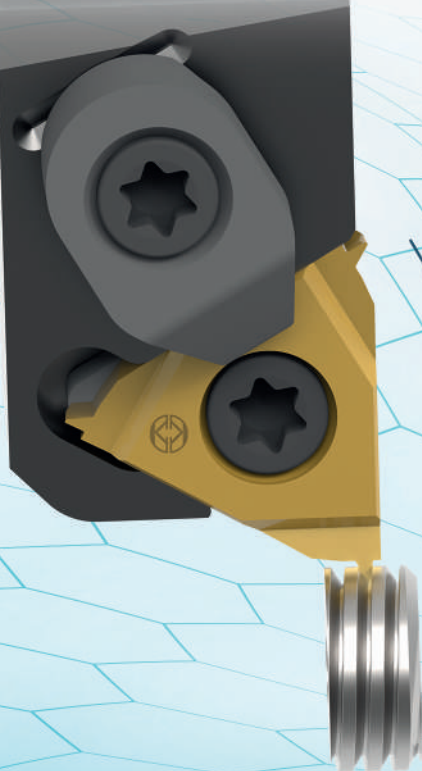
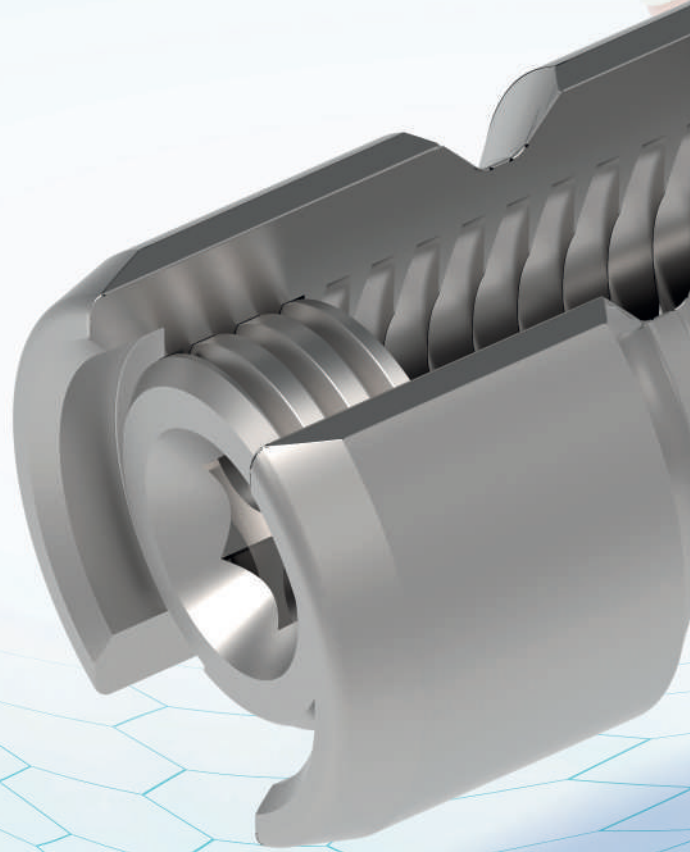

**DIŞ AÇMA**  
**THREADING**  
*GEWINDE*



**ALIN ÖZEL FORM**  
**FACE SPECIAL FORMING**  
*ALIN SONDERFORM*

**ALYAN PUNCH**

**ALLEN PUNCH**  
*WINKELSCHRAUBENDEHER WERKZEUGE*

**WHIRLING**  
**WHIRLING**  
*WENDESCHNEIDPLATTEN*

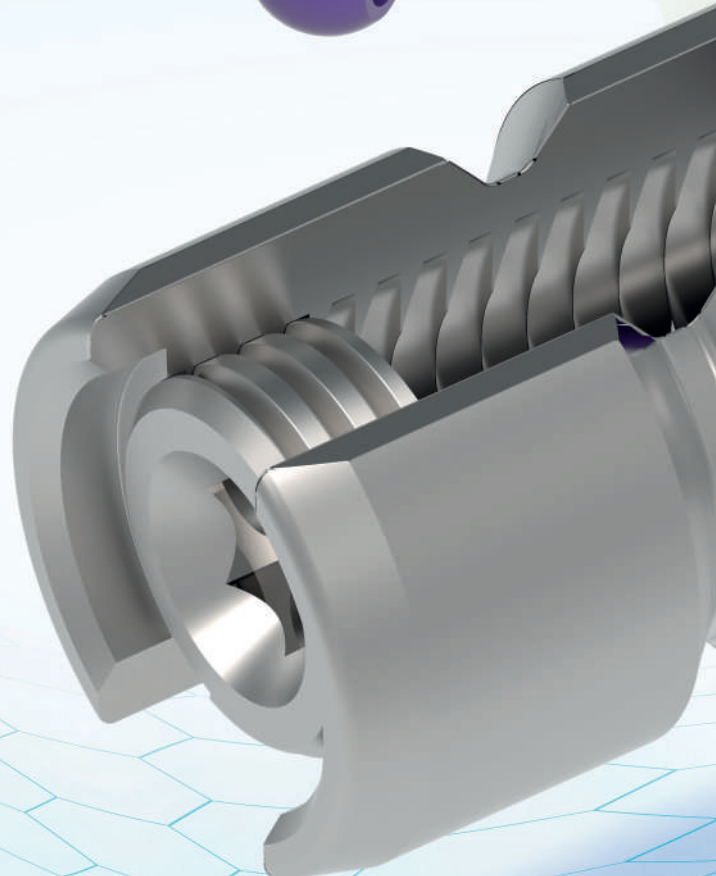
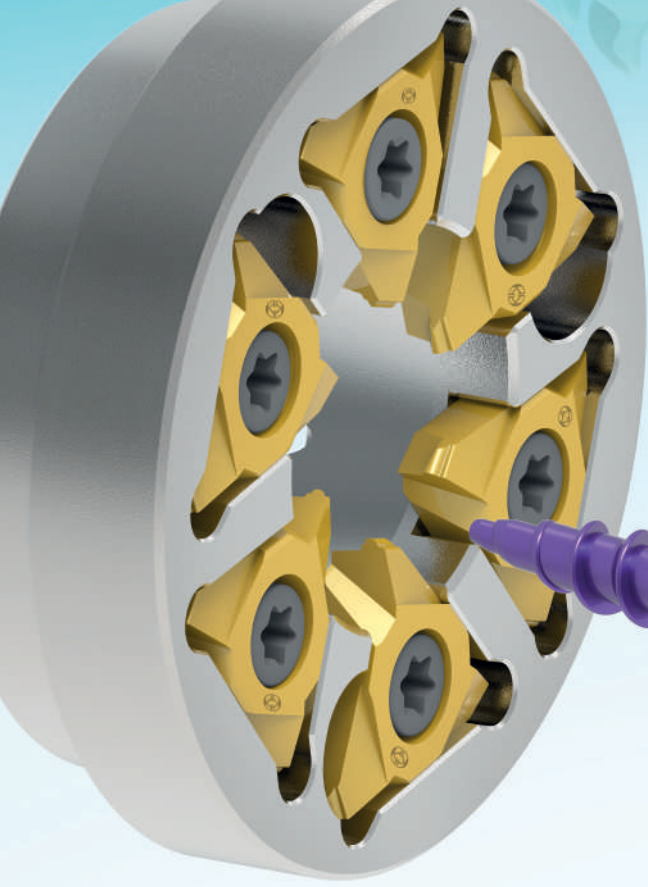

**ALYAN / PUNCH - KAZIMA**

**ALLEN / PUNCH - BROACH**  
*WINKELSCHRAUBENDEHER  
WERKZEUGE*

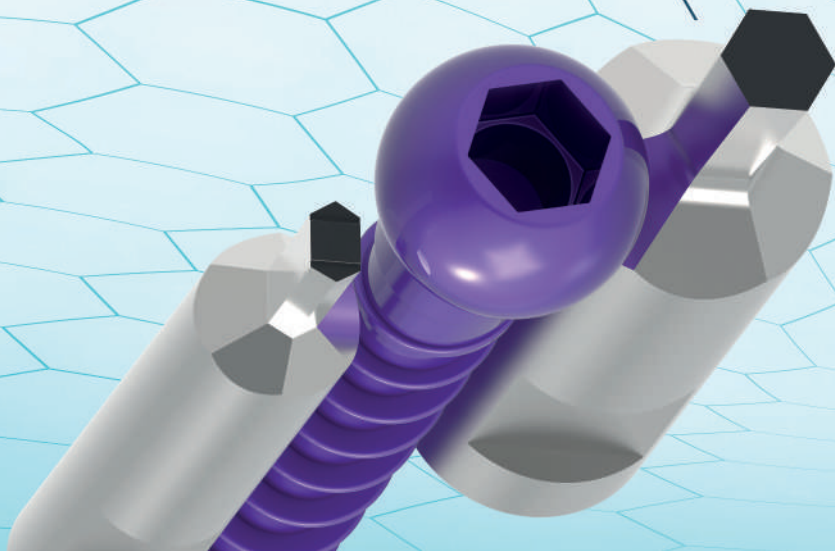



# IMPLANT SCREW

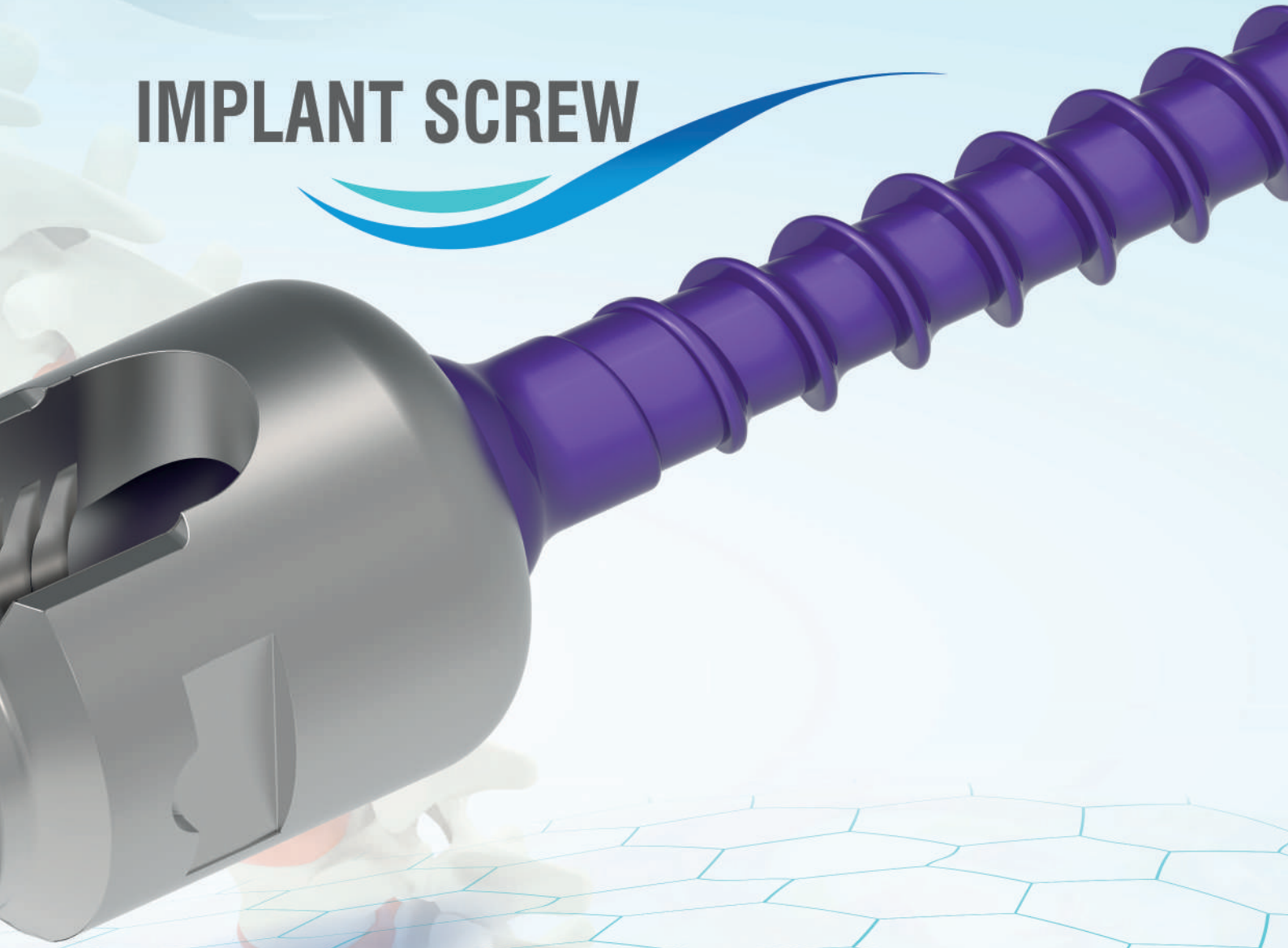

**TORX / PUNCH - KAZIMA**

***TORX / PUNCH - BROACH***

***WINKELSCHRAUBENDREHER - RING***

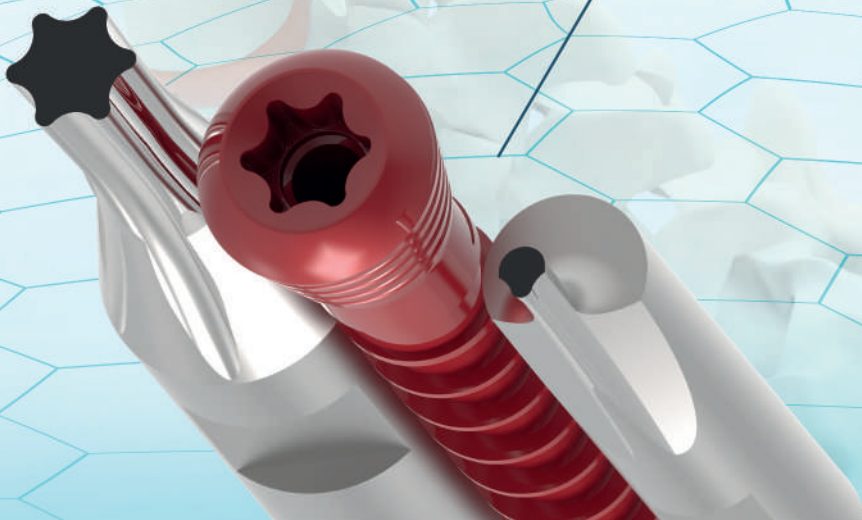

# WHIRLING

**WHIRLING UÇLARI ve TAKIMLARI**

*WHIRLING INSERTS and TOOLHOLDERS*

*WENDESCHNEIDPLATTEN UND WERKZEUGHALTER ZUM  
GEWINDEWIRBELN*



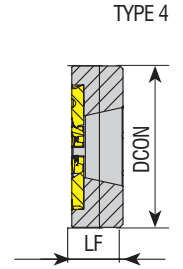
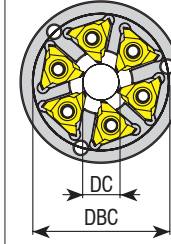
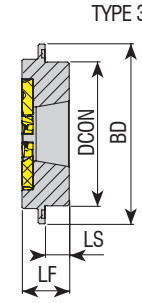
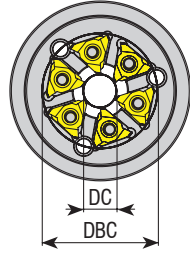
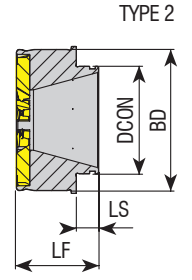
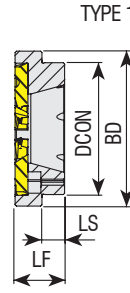
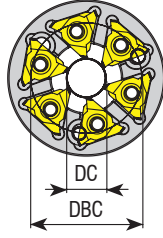

Makine Machine Maschine	Tahrikli WHIRLING Ünitesi Aggregate WHIRLING Unit Wirbelspindel	WHIRLING Ring Kodu WHIRLING Ring Code Wirbelring	Stok Stock Lager	Takım Ölçüleri (mm) Dimension (mm) Abmessung (mm)								Kesici Uç Insert Wendeschneidplatte	Yedek Parçaları / Spare Parts / Ersatzteile				
				ZEPF	DC	DCON	DBC	BD	LS	LF	TYPE		Sıkma Vidası Screw Schraube	Tork Anahtar Torx Key Torx-Schlüssel			
STAR	5914 72 00/68172	ATW-301-T09-D1240-Z06	●	6	12	40	33	47	7	15	1						
CITIZEN	BTW1000	ATW-302-T09-D1233-Z06	○	6	12	33	40	47	4	18.5	-						
	GSW101	ATW-303-T09-D0620-Z06	○	6	6	20	26	35	3.2	15	1						
	MWS101/KSW101	ATW-304-T09-D1240-Z06	○	6	12	40	32.5	46	2.5	15.5	1						
	LSW101/BSW215/ LSW215315																
	LSW424														ATW-305-T09-D1245-Z06	○	6
TORNOS	306101/307087	ATW-306-T09-D1240-Z06	●	6	12	40	31	57	3.5	15	-				T09....	4015 M4x11	80-T15
	417617	ATW-307-T09-D1250-Z06	○	6	12	50	40	67	3.5	15.4	-						
WTO	TN762004	ATW-308-T09-D1142-Z06	●	6	11	31.97	-	42	6.7	24.7	2						
	TN762006	ATW-309-T09-D2054-Z08	○	8	20	56.5	-	54	1.5	13.8	2						
TSUGAMI	3234 Y342	ATW-310-T09-D1252-Z06	●	6	12	52	42	65	8.7	17	3						
	3268 Y452	ATW-311-T09-D1252-Z06	○	6	12	52	44	52	10	10	3						
	3268 Y271	ATW-312-T09-D1252-Z06	○	6	12	52	38	54	6	19	3						
	3214 Y342	ATW-313-T09-D1650-Z06	○	6	16	50	40	62	8.5	20	3						
	3234 Y342	ATW-314-T09-D2052-Z06	○	6	20	52	42	65	8.7	17	3						
	3281-Y451	ATW-316-T09-D1252-Z06	●	6	12	52	44	52	-	17	4						
HANWHA	MADAULA	ATW-315-T09-D1245-Z06	○	6	12	45	-	56	8.5	15	1						

R: Sağ / Right / Rechts L: Sol / Left / Links

● Stokta / In Stock / Auf Lager ○ Stokta Yok / Non Stock Item / Kein Lagerartikel, Lieferzeit auf Anfrage

Sipariş Örneği/Ordering Example/Bestellbeispiel

1 ad./pcs./stück ATW-301-T09-D1240-Z06



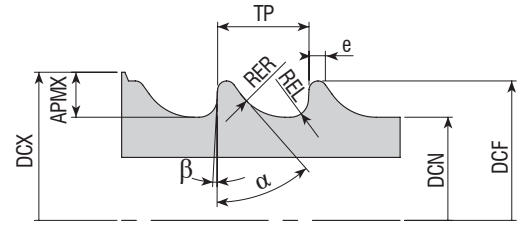
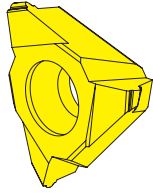
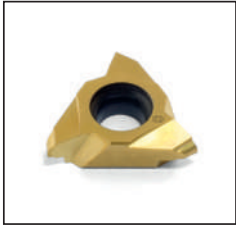

Uç Kodu Insert Code Wendepplatten-Bezeichnung	Kalite Grade Sorte		Standart ISO5835	Uç Ölçüleri (mm) Insert Dimension (mm) Abmessung (mm)									
	VK15U	VK15U01		TP	e	DCF	DCN	RER	REL	α	β	APMX	DCX
T09.HA150.D12	●	●	HA1.5	0.5	0.1	1.35 to 1.5	1.0 to 1.1	0.30	0.1	35°	3°	4	9
T09.HA200.D12	●	●	HA2.0	0.6	0.1	1.85 to 2.0	1.2 to 1.3	0.40	0.1	35°	3°	4	9
T09.HA270.D12	●	●	HA2.7	1	0.1	2.55 to 2.7	1.75 to 1.9	0.60	0.2	35°	3°	4	9.5
T09.HA350.D12	●	●	HA3.5	1.25	0.1	3.35 to 3.5	2.25 to 2.4	0.80	0.2	35°	3°	4	10
T09.HA400.D12	●	●	HA4.0	1.5	0.1	3.85 to 4.0	2.75 to 2.9	0.80	0.2	35°	3°	4	10.5
T09.HA450.D12	●	●	HA4.5	1.75	0.1	4.35 to 4.5	2.85 to 3.0	1.00	0.3	35°	3°	4	11
T09.HA500.D12	●	●	HA5.0	1.75	0.1	4.85 to 5.0	3.35 to 3.5	1.00	0.3	35°	3°	4	11
T09.HB400.D12	●	●	HB4.0	1.75	0.1	3.85 to 4.0	1.75 to 1.9	0.80	0.3	25°	5°	4	9.5
T09.HB650.D12	●	●	HB6.5	2.75	0.2	6.35 to 6.5	2.85 to 3.0	1.20	0.8	25°	5°	4	11

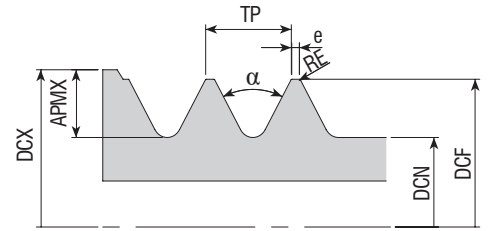
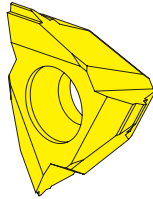
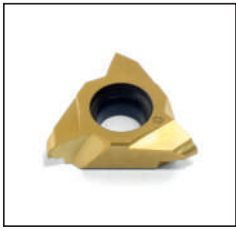

Uç Kodu Insert Code Wendepplatten-Bezeichnung	Kalite Grade Sorte		Standart ISO9268	Uç Ölçüleri (mm) Insert Dimension (mm) Abmessung (mm)							
	VK15U	VK15U01		TP	e	DCF	DCN	α	RE	APMX	DCX
T09.HC290.D12	○	○	HC2.9	1.06	0.1	2.79 to 2.90	2.03 to 2.18	60°	0.01	4	10.5
T09.HC350.D12	○	○	HC3.5	1.27	0.1	3.43 to 3.53	2.51 to 2.64	60°	0.01	4	11
T09.HC390.D12	○	○	HC3.9	1.27	0.1	3.78 to 3.91	2.77 to 2.92	60°	0.01	4	11.5
T09.HC420.D12	○	○	HC4.2	1.27	0.1	4.09 to 4.22	2.95 to 3.25	60°	0.01	4	12

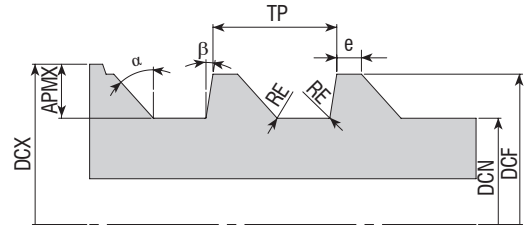
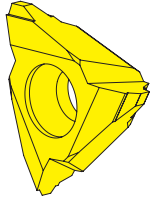
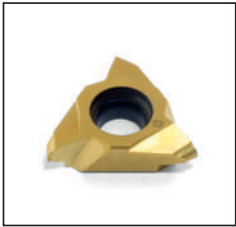

Uç Kodu Insert Code Wendepplatten-Bezeichnung	Kalite Grade Sorte		Standart ISO9268	Uç Ölçüleri (mm) Insert Dimension (mm) Abmessung (mm)								
	VK15U	VK15U01		TP	e	DCF	DCN	RE	α	β	APMX	DCX
T09.HD400.D12	○	○	HD4.0	1.59	0.1	3.97 to 4.03	2.89 to 2.95	0.01	45°	10°	4	11.5
T09.HD450.D12	○	○	HD4.5	2.18	0.1	4.47 to 4.53	2.89 to 2.95	0.01	45°	10°	4	12

R: Sağ / Right / Rechts L: Sol / Left / Links

● Stokta / In Stock / Auf Lager ○ Stokta Yok / Non Stock Item / Kein Lagerartikel, Lieferzeit auf Anfrage

Sipariş Örneği/Ordering Example/Bestellbeispiel

1 ad./pcs./stück T09.HA150.D12



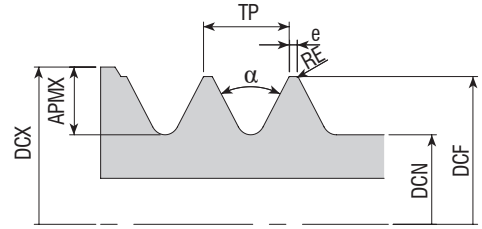
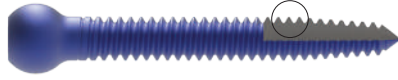
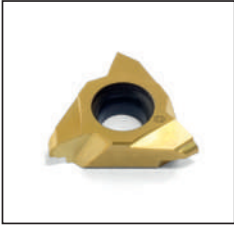

Uç Kodu Insert Code Wendeplatten-Bezeichnung	Kalite Grade Sorte		Standart DIN13	Uç Ölçüleri (mm) Insert Dimension (mm) Abmessung (mm)						
	VK15U	VK15U01		TP	DCF	DCN	a	RE	APMX	DCX
T09.M200.D12	●	●	M2	0.4	2	1.509	60	0.048	4	9
T09.M250.D12	●	●	M2.5	0.45	2.5	1.928	60	0.055	4	9.5
T09.M300.D12	●	●	M3	0.5	3	2.387	60	0.062	4	10
T09.M350.D12	●	●	M3.5	0.6	3.5	2.744	60	0.077	4	8.5
T09.M400.D12	●	●	M4.0	0.7	4	3.141	60	0.091	4	11
T09.M500.D12	●	●	M5.0	0.8	5	4.019	60	0.105	4	11.5
T09.M600.D12	●	●	M6.0	1	6	4.773	60	0.134	4	12.5
T09.M700.D12	●	●	M7.0	1	7	5.753	60	0.134	4	13.5
T09.M800.D12	●	●	M8.0	1.25	8	6.446	60	0.17	4	14

Kesme başlangıç pozisyonu  
Cutting Start Position  
Startposition Schneidvorgang

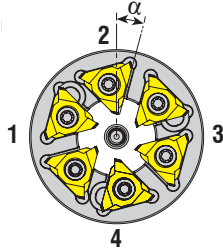

Y Eksen  
Y Axis  
Y Oсь

İş parçası dönüş yönü  
Turning Direction of Workpiece  
Drehrichtung Werkstück

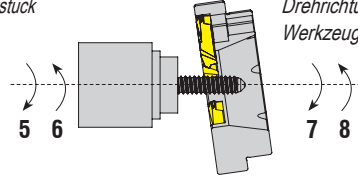

WHIRLING ünitesi dönüş yönü  
Turning Direction of WHIRLING unit  
Drehrichtung Gewindewirbel  
Werkzeug

Makine Özellikleri Machine Specifications Angaben zur Maschine		Malzeme Özellikleri Material Specifications Material Besonderheiten	
<b>Makine Üreticisi</b> Machine Manufacturer Maschinenhersteller		<b>Malzeme (DIN, AISI v.b.)</b> Material (DIN, AISI etc.) Material DIN, AISI etc.	
<b>Makine Modeli</b> Machine Model Maschinenbezeichnung		<b>Ham Malzeme Çapı</b> Raw Material Diameter Rohmaterial Durchmesser	
<b>Tahrikli WHIRLING Ünitesi Üreticisi</b> Live Tool Manufacturer Hersteller angetriebene Werkzeuge		<b>Diş Profili</b> Thread Profile Gewindeprofil	
<b>Tahrikli WHIRLING Ünitesi</b> Aggregate WHIRLING Unit Wirbelspindel		<b>Profil Teknik Resmi</b> Profile Technical Drawing Profilzeichnung	
<b>Y - Eksen</b> Y - Axis Y - Achse	<b>Var</b> Exist Ja <input type="checkbox"/>	<b>Yok</b> None Nein <input type="checkbox"/>	<b>Hatve</b> Pitch Steigung
<b>Yüksek Basıncılı Soğutma</b> High Pressure Coolant Hochdruckkühlung	<b>Var</b> Exist Ja <input type="checkbox"/>	<b>Yok</b> None Nein <input type="checkbox"/>	<b>Tek Ağız</b> One Start Eingängig
<b>Kesme Başlangıç Pozisyonu</b> Cutting Start Position Startposition Schneidvorgang	1 <input type="checkbox"/> 2 <input type="checkbox"/> 3 <input type="checkbox"/> 4 <input type="checkbox"/>		<b>İki Ağız</b> Two Starts Zweigängig
<b>WHIRLING Ünitesi Dönüş Yönü</b> Turning Direction of WHIRLING Unit Drehrichtung Gewindewirbel-Werkzeug	5 <input type="checkbox"/> 6 <input type="checkbox"/>		<b>Müşteri Adı / Customer Name / Kundennaame:</b>
<b>İş Parçası Dönüş Yönü</b> Turning Direction of Workpiece Drehrichtung Werkstück	7 <input type="checkbox"/> 8 <input type="checkbox"/>		<b>Yetkili / Responsible Person / Ansprechpartner :</b>
<b>α Açısı</b> α Angle Winkel	<b>Not: Bu açı ürün performansına etki ettiğinden bildirilmesi gerekmektedir. Aksi halinde ring tarafımıza gönderilmelidir.</b> Note: This angle effects the performance of inserts. If doesn't known, tool body should be send to AKKO. Hinweis: Dieser Winkel beeinflusst die Leistung der Wendeschnidplatte. Sollte dieser Winkel unbekannt sein, können Sie das Werkzeug zur Fa. AKKO schicken.		
<b>Not / Note / Notizen :</b>			

# MINI CUT TAKIMLAR

MINI CUT TOOLS

MINI CUT WERKZEUGE

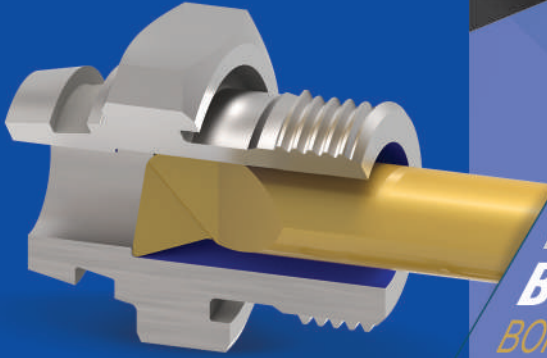

01

DELİK İÇİ TORNALAMA  
**BORING**  
BOHREN

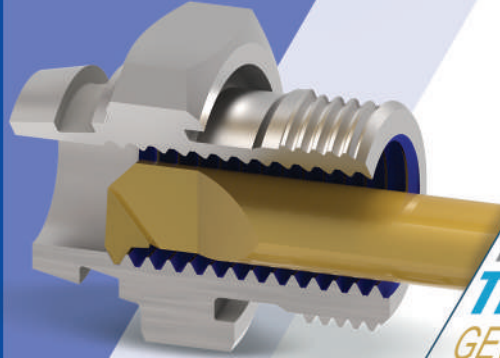

02

DIŞ AÇMA  
**THREADING**  
GEWINDE

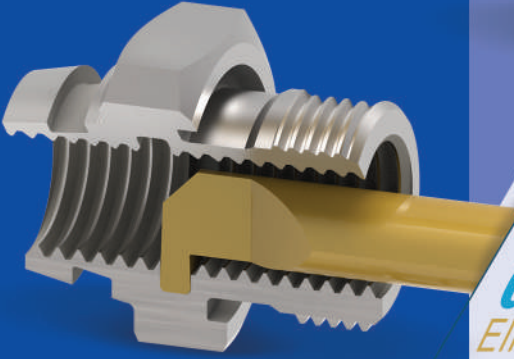

03

KANAL AÇMA  
**GROOVING**  
EINSTECHBOHRUNG

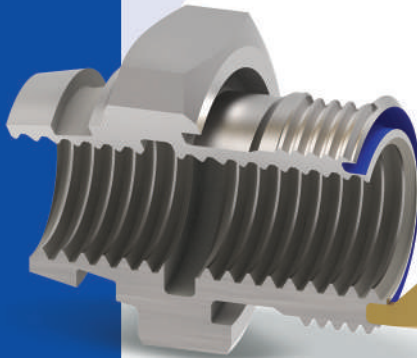

04

YÜZEY KANAL AÇMA  
**FACE GROOVING**  
OBERFLÄCHENEINSTECHBOHRUNG

## MINI CUT BORING DELİK İÇİ MINI CUT TAKIMLAR

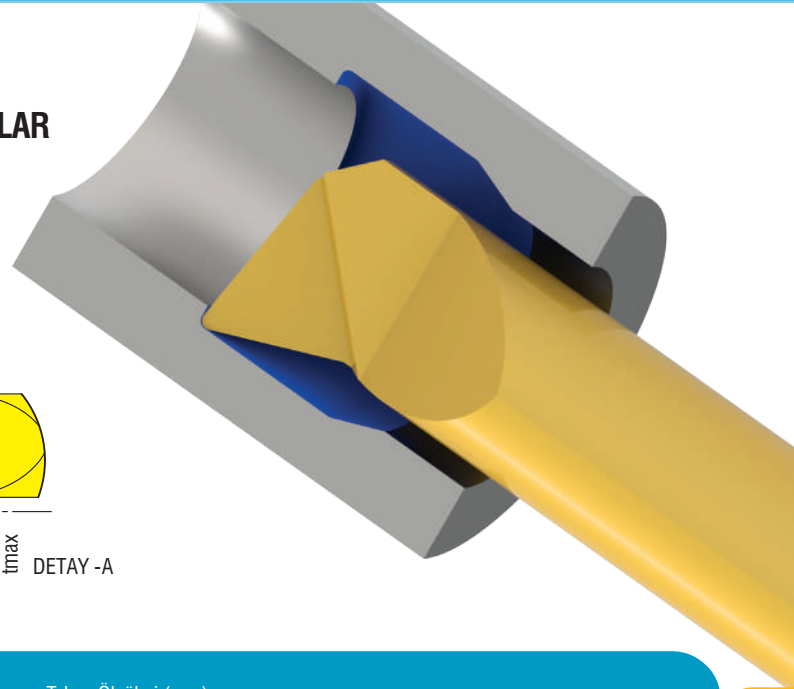
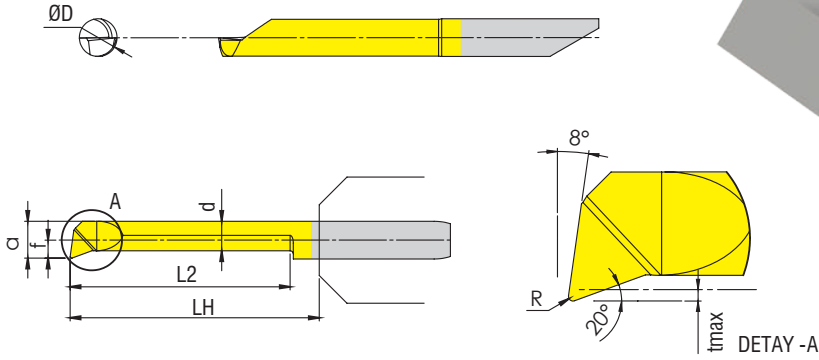

Ürün Kodu  
Product Code  
Artikelnummer

Takım Ölçüleri (mm)  
Dimension (mm)  
Abmessung (mm)

	L2	Ødmin	R	a	d	f	LH	tmax	ØD
APB04.102.015	10.2	4.2	0.15	3.95	3.45	1.95	13	0.3	4
APB04.152.015	15.20	4.2	0.15	3.95	3.45	1.95	18	0.3	4
APB04.203.015	20.30	4.2	0.15	3.95	3.45	1.95	23	0.3	4
APB04.254.015	25.40	4.2	0.15	3.95	3.45	1.95	28	0.3	4
APB04.305.015	30.50	4.2	0.15	3.95	3.45	1.95	33	0.3	4
APB04.356.015	35.60	4.2	0.15	3.95	3.45	1.95	38	0.3	4
APB05.102.020	10.2	5.2	0.2	4.95	4.25	2.45	13	0.5	5
APB05.152.020	15.20	5.2	0.2	4.95	4.25	2.45	18	0.5	5
APB05.203.020	20.30	5.2	0.2	4.95	4.25	2.45	23	0.5	5
APB05.254.020	25.40	5.2	0.2	4.95	4.25	2.45	28	0.5	5
APB05.305.020	30.50	5.2	0.2	4.95	4.25	2.45	33	0.5	5
APB05.356.020	35.60	5.2	0.2	4.95	4.25	2.45	38	0.5	5
APB05.406.020	40.60	5.2	0.2	4.95	4.25	2.45	43	0.5	5
APB06.102.020	10.2	6.2	0.2	5.95	5.25	2.95	13	0.5	6
APB06.152.020	15.20	6.2	0.2	5.95	5.25	2.95	18	0.5	6
APB06.203.020	20.30	6.2	0.2	5.95	5.25	2.95	23	0.5	6
APB06.254.020	25.40	6.2	0.2	5.95	5.25	2.95	28	0.5	6
APB06.305.020	30.50	6.2	0.2	5.95	5.25	2.95	33	0.5	6
APB06.356.020	35.60	6.2	0.2	5.95	5.25	2.95	38	0.5	6
APB06.406.020	40.60	6.2	0.2	5.95	5.25	2.95	43	0.5	6
APB06.508.020	50.80	6.2	0.2	5.95	5.25	2.95	53	0.5	6
APB07.254.020	25.40	7.2	0.2	6.95	6.25	3.45	28	0.5	7
APB07.305.020	30.50	7.2	0.2	6.95	6.25	3.45	33	0.5	7
APB07.356.020	35.60	7.2	0.2	6.95	6.25	3.45	38	0.5	7
APB07.406.020	40.60	7.2	0.2	6.95	6.25	3.45	43	0.5	7
APB07.508.020	50.80	7.2	0.2	6.95	6.25	3.45	53	0.5	7
APB07.608.020	60.80	7.2	0.2	6.95	6.25	3.45	63	0.5	7

Sipariş Örneği/Ordering Example/Bestellbeispiel  
1 ad./pcs./stück APB.04.102.015

## MINI CUT GROOVING

### KANAL AÇMA MİNİ CUT TAKIMLAR

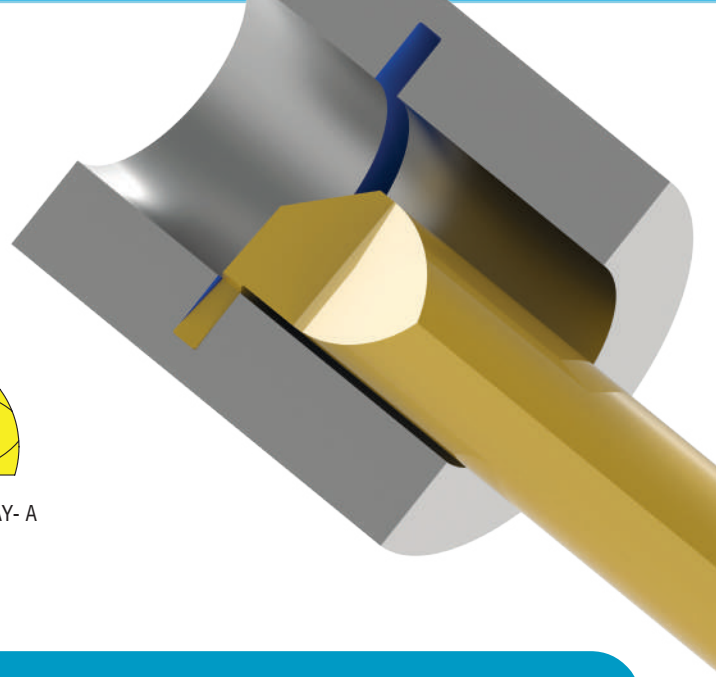
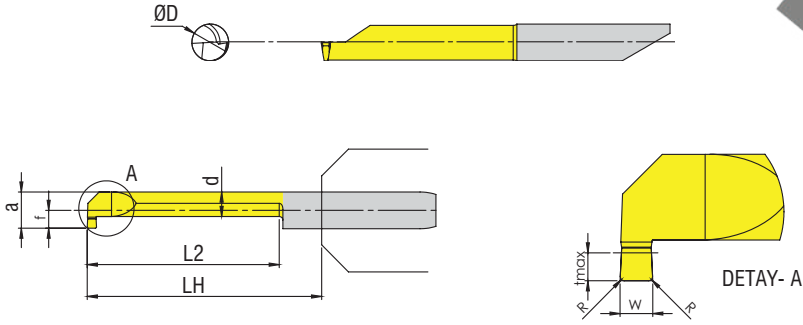

Ürün Kodu  
Product Code  
Artikelnummer

Takım Ölçüleri (mm)  
Dimension (mm)  
Abmessung (mm)

	W	L2	Ødmin	R	a	d	f	LH	tmax	ØD
APG04.080.102	0.8	10.2	4.2	-	3.95	2.95	1.95	13	0.8	4
APG04.080.152	0.8	15.2	4.2	-	3.95	2.95	1.95	18	0.8	4
APG04.080.203	0.8	20.3	4.2	-	3.95	2.95	1.95	23	0.8	4
APG04.080.254	0.8	25.4	4.2	-	3.95	2.95	1.95	28	0.8	4
APG04.100.102	1.0	10.2	4.2	-	3.95	2.95	1.95	13	1.0	4
APG04.100.152	1.0	15.2	4.2	-	3.95	2.95	1.95	18	1.0	4
APG04.100.203	1.0	20.3	4.2	-	3.95	2.95	1.95	23	1.0	4
APG05.079.102	0.79	10.2	5.2	-	4.95	3.75	2.45	13	1.0	5
APG05.079.152	0.79	15.2	5.2	-	4.95	3.75	2.45	18	1.0	5
APG05.079.203	0.79	20.3	5.2	-	4.95	3.75	2.45	23	1.0	5
APG05.079.254	0.79	25.4	5.2	-	4.95	3.75	2.45	28	1.0	5
APG05.079.305	0.79	30.5	5.2	-	4.95	3.75	2.45	33	1.0	5
APG05.079.356	0.79	35.6	5.2	-	4.95	3.75	2.45	38	1.0	5
APG05.100.102	1.0	10.2	5.2	-	4.95	3.75	2.45	13	1.0	5
APG05.100.152	1.0	15.2	5.2	-	4.95	3.75	2.45	18	1.0	5
APG05.100.203	1.0	20.3	5.2	-	4.95	3.75	2.45	23	1.0	5
APG05.100.254	1.0	25.4	5.2	-	4.95	3.75	2.45	28	1.0	5
APG05.100.305	1.0	30.5	5.2	-	4.95	3.75	2.45	33	1.0	5
APG05.100.356	1.0	35.6	5.2	-	4.95	3.75	2.45	38	1.0	5

Sipariş Örneği/Ordering Example/Bestellbeispiel  
1 ad./pcs./stück APG04.080.102



## MINI CUT GROOVING KANAL AÇMA MİNİ CUT TAKIMLAR

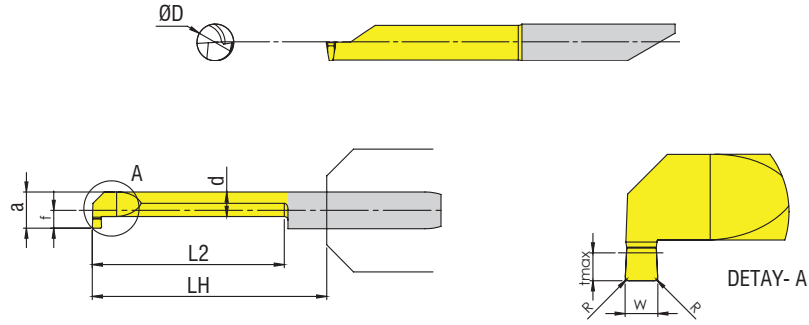

Ürün Kodu  
Product Code  
Artikelnummer

Takım Ölçüleri (mm)  
Dimension (mm)  
Abmessung (mm)

	W	L2	Ødmin	R	a	d	f	LH	tmax	ØD
APG05.117.102	1.17	10.2	5.2	-	4.95	3.75	2.45	13	1.0	5
APG05.117.152	1.17	15.2	5.2	-	4.95	3.75	2.45	18	1.0	5
APG05.117.203	1.17	20.3	5.2	-	4.95	3.75	2.45	23	1.0	5
APG05.117.254	1.17	25.4	5.2	-	4.95	3.75	2.45	28	1.0	5
APG05.117.305	1.17	30.5	5.2	-	4.95	3.75	2.45	33	1.0	5
APG05.117.356	1.17	35.6	5.2	-	4.95	3.75	2.45	38	1.0	5
APG05.150.102	1.5	10.2	5.2	-	4.95	3.75	2.45	13	1.0	5
APG05.150.152	1.5	15.2	5.2	-	4.95	3.75	2.45	18	1.0	5
APG05.150.203	1.5	20.3	5.2	-	4.95	3.75	2.45	23	1.0	5
APG05.150.254	1.5	25.4	5.2	-	4.95	3.75	2.45	28	1.0	5
APG05.150.305	1.5	30.5	5.2	-	4.95	3.75	2.45	33	1.0	5
APG05.150.356	1.5	35.6	5.2	-	4.95	3.75	2.45	38	1.0	5
APG05.157.102	1.57	10.2	5.2	-	4.95	3.75	2.45	13	1.0	5
APG05.157.152	1.57	15.2	5.2	-	4.95	3.75	2.45	18	1.0	5
APG05.157.203	1.57	20.3	5.2	-	4.95	3.75	2.45	23	1.0	5
APG05.157.254	1.57	25.4	5.2	-	4.95	3.75	2.45	28	1.0	5
APG05.157.305	1.57	30.5	5.2	-	4.95	3.75	2.45	33	1.0	5

Sipariş Örneği/Ordering Example/Bestellbeispiel  
1 ad./pcs./stück APG05.117.102

## MINI CUT GROOVING

### KANAL AÇMA MİNİ CUT TAKIMLAR

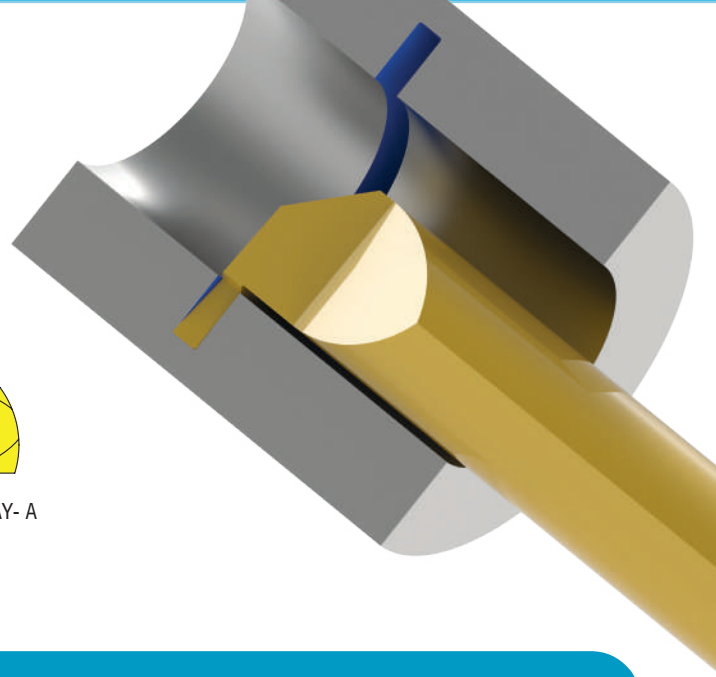
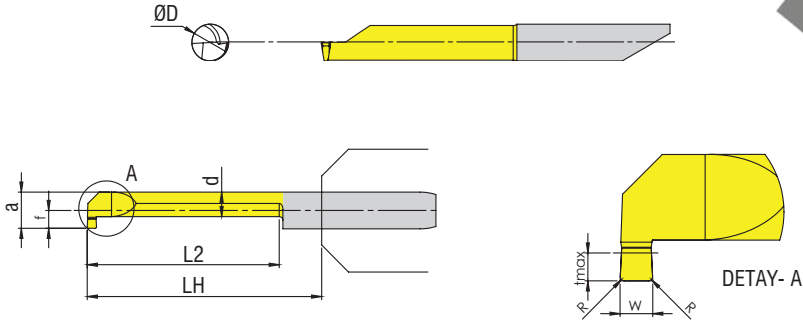

Ürün Kodu  
Product Code  
Artikelnummer

Takım Ölçüleri (mm)  
Dimension (mm)  
Abmessung (mm)

	W	L2	Ødmin	R	a	d	f	LH	tmax	ØD
APG05.198.102	1.98	10.2	5.2	-	4.95	3.75	2.45	13	1.0	5
APG05.198.152	1.98	15.2	5.2	-	4.95	3.75	2.45	18	1.0	5
APG05.198.203	1.98	20.3	5.2	-	4.95	3.75	2.45	23	1.0	5
APG05.198.254	1.98	25.4	5.2	-	4.95	3.75	2.45	28	1.0	5
APG05.198.305	1.98	30.5	5.2	-	4.95	3.75	2.45	33	1.0	5
APG05.200.102	2.0	10.2	5.2	-	4.95	3.75	2.45	13	1.0	5
APG05.200.152	2.0	15.2	5.2	-	4.95	3.75	2.45	18	1.0	5
APG05.200.203	2.0	20.3	5.2	-	4.95	3.75	2.45	23	1.0	5
APG05.200.254	2.0	25.4	5.2	-	4.95	3.75	2.45	28	1.0	5
APG05.200.305	2.0	30.5	5.2	-	4.95	3.75	2.45	33	1.0	5
APG06.079.102	0.79	10.2	6.2	-	5.95	3.95	2.95	13	1.8	6
APG06.079.152	0.79	15.2	6.2	-	5.95	3.95	2.95	18	1.8	6
APG06.079.203	0.79	20.3	6.2	-	5.95	3.95	2.95	23	1.8	6
APG06.079.254	0.79	25.4	6.2	-	5.95	3.95	2.95	28	1.8	6
APG06.079.305	0.79	30.5	6.2	-	5.95	3.95	2.95	33	1.8	6
APG06.079.356	0.79	35.6	6.2	-	5.95	3.95	2.95	38	1.8	6

Sipariş Örneği/Ordering Example/Bestellbeispiel  
1 ad./pcs./stück APG05.198.102

## MINI CUT GROOVING KANAL AÇMA MİNİ CUT TAKIMLAR

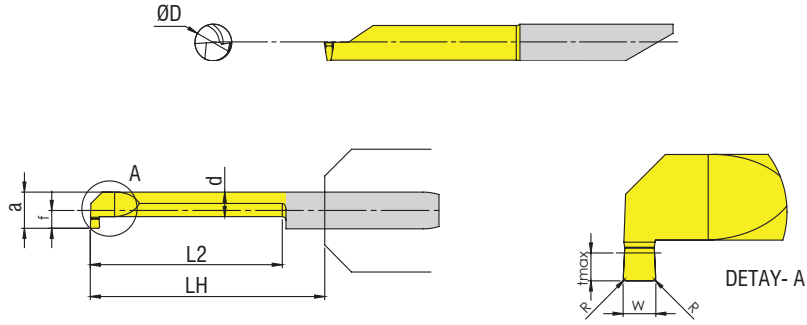

Ürün Kodu  
Product Code  
Artikelnummer

Takım Ölçüleri (mm)  
Dimension (mm)  
Abmessung (mm)

	W	L2	Ødmin	R	a	d	f	LH	tmax	ØD
APG06.100.102	1.0	10.2	6.2	-	5.95	3.95	2.95	13	1.8	6
APG06.100.152	1.0	15.2	6.2	-	5.95	3.95	2.95	18	1.8	6
APG06.100.203	1.0	20.3	6.2	-	5.95	3.95	2.95	23	1.8	6
APG06.100.254	1.0	25.4	6.2	-	5.95	3.95	2.95	28	1.8	6
APG06.100.305	1.0	30.5	6.2	-	5.95	3.95	2.95	33	1.8	6
APG06.100.356	1.0	35.6	6.2	-	5.95	3.95	2.95	38	1.8	6
APG06.100.406	1.0	40.6	6.2	-	5.95	3.95	2.95	43	1.8	6
APG06.117.102	1.17	10.2	6.2	-	5.95	3.95	2.95	13	1.8	6
APG06.117.152	1.17	15.2	6.2	-	5.95	3.95	2.95	18	1.8	6
APG06.117.203	1.17	20.3	6.2	-	5.95	3.95	2.95	23	1.8	6
APG06.117.254	1.17	25.4	6.2	-	5.95	3.95	2.95	28	1.8	6
APG06.117.305	1.17	30.5	6.2	-	5.95	3.95	2.95	33	1.8	6
APG06.117.356	1.17	35.6	6.2	-	5.95	3.95	2.95	38	1.8	6
APG06.117.406	1.17	40.6	6.2	-	5.95	3.95	2.95	43	1.8	6
APG06.150.102	1.5	10.2	6.2	-	5.95	3.95	2.95	13	1.8	6
APG06.150.152	1.5	15.2	6.2	-	5.95	3.95	2.95	18	1.8	6
APG06.150.203	1.5	20.3	6.2	-	5.95	3.95	2.95	23	1.8	6
APG06.150.254	1.5	25.4	6.2	-	5.95	3.95	2.95	28	1.8	6
APG06.150.305	1.5	30.5	6.2	-	5.95	3.95	2.95	33	1.8	6
APG06.150.356	1.5	35.6	6.2	-	5.95	3.95	2.95	38	1.8	6

Sipariş Örneği/Ordering Example/Bestellbeispiel  
1 ad./pcs./stück APG06.100.102

## MINI CUT GROOVING

### KANAL AÇMA MİNİ CUT TAKIMLAR

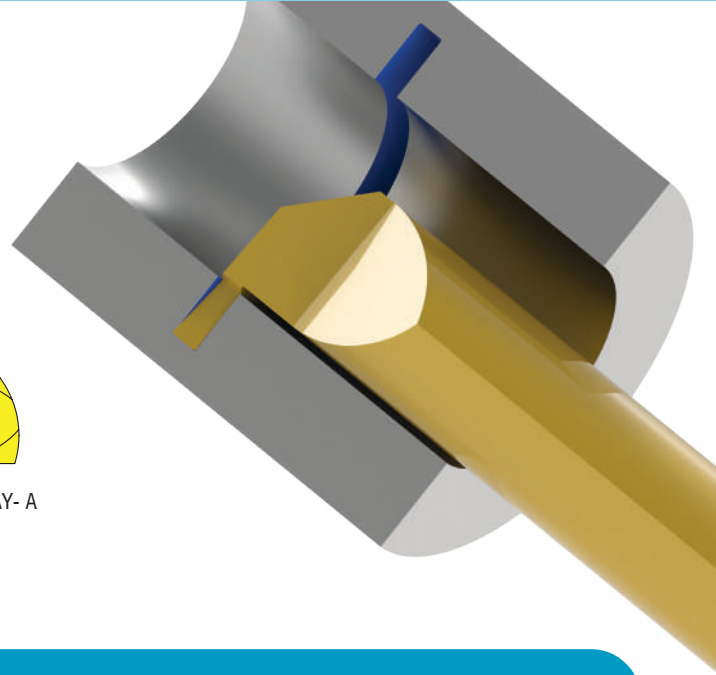
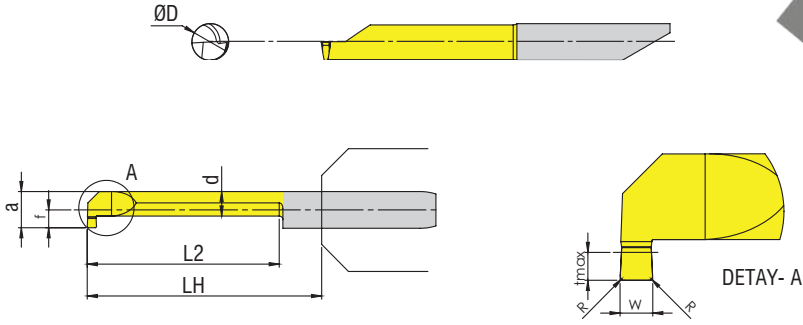

Ürün Kodu  
Product Code  
Artikelnummer

Takım Ölçüleri (mm)  
Dimension (mm)  
Abmessung (mm)

	W	L2	Ødmin	R	a	d	f	LH	tmax	ØD
APG06.157.102	1.57	10.2	6.2	-	5.95	3.95	2.95	13	1.8	6
APG06.157.152	1.57	15.2	6.2	-	5.95	3.95	2.95	18	1.8	6
APG06.157.203	1.57	20.3	6.2	-	5.95	3.95	2.95	23	1.8	6
APG06.157.254	1.57	25.4	6.2	-	5.95	3.95	2.95	28	1.8	6
APG06.157.305	1.57	30.5	6.2	-	5.95	3.95	2.95	33	1.8	6
APG06.157.356	1.57	35.6	6.2	-	5.95	3.95	2.95	38	1.8	6
APG06.157.406	1.57	40.6	6.2	-	5.95	3.95	2.95	43	1.8	6
APG06.198.102	1.98	10.2	6.2	-	5.95	3.95	2.95	13	1.8	6
APG06.198.152	1.98	15.2	6.2	-	5.95	3.95	2.95	18	1.8	6
APG06.198.203	1.98	20.3	6.2	-	5.95	3.95	2.95	23	1.8	6
APG06.198.254	1.98	25.4	6.2	-	5.95	3.95	2.95	28	1.8	6
APG06.198.305	1.98	30.5	6.2	-	5.95	3.95	2.95	33	1.8	6
APG06.198.356	1.98	35.6	6.2	-	5.95	3.95	2.95	38	1.8	6
APG06.198.406	1.98	40.6	6.2	-	5.95	3.95	2.95	43	1.8	6
APG06.200.102	2.0	10.2	6.2	-	5.95	3.95	2.95	13	1.8	6
APG06.200.152	2.0	15.2	6.2	-	5.95	3.95	2.95	18	1.8	6
APG06.200.203	2.0	20.3	6.2	-	5.95	3.95	2.95	23	1.8	6
APG06.200.254	2.0	25.4	6.2	-	5.95	3.95	2.95	28	1.8	6
APG06.200.305	2.0	30.5	6.2	-	5.95	3.95	2.95	33	1.8	6
APG06.200.356	2.0	35.6	6.2	-	5.95	3.95	2.95	38	1.8	6

Sipariş Örneği/Ordering Example/Bestellbeispiel  
1 ad./pcs./stück APG06.157.102



## MINI CUT GROOVING KANAL AÇMA MİNİ CUT TAKIMLAR

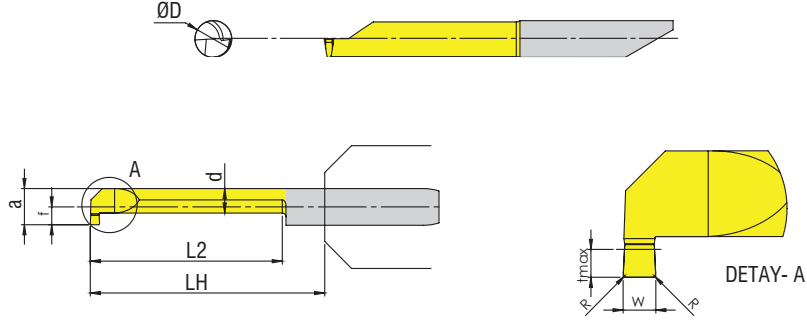

Ürün Kodu  
Product Code  
Artikelnummer

Takım Ölçüleri (mm)  
Dimension (mm)  
Abmessung (mm)

	W	L2	Ødmin	R	a	d	f	LH	tmax	ØD
APG07.079.102	0.79	10.2	7.2	-	6.95	4.25	3.45	13	2.5	7
APG07.079.152	0.79	15.2	7.2	-	6.95	4.25	3.45	18	2.5	7
APG07.079.203	0.79	20.3	7.2	-	6.95	4.25	3.45	23	2.5	7
APG07.079.254	0.79	25.4	7.2	-	6.95	4.25	3.45	28	2.5	7
APG07.079.305	0.79	30.5	7.2	-	6.95	4.25	3.45	33	2.5	7
APG07.079.356	0.79	35.6	7.2	-	6.95	4.25	3.45	38	2.5	7
APG07.079.406	0.79	40.6	7.2	-	6.95	4.25	3.45	43	2.5	7
APG07.100.102	1.0	10.2	7.2	-	6.95	4.25	3.45	13	2.5	7
APG07.100.152	1.0	15.2	7.2	-	6.95	4.25	3.45	18	2.5	7
APG07.100.203	1.0	20.3	7.2	-	6.95	4.25	3.45	23	2.5	7
APG07.100.254	1.0	25.4	7.2	-	6.95	4.25	3.45	28	2.5	7
APG07.100.305	1.0	30.5	7.2	-	6.95	4.25	3.45	33	2.5	7
APG07.100.356	1.0	35.6	7.2	-	6.95	4.25	3.45	38	2.5	7
APG07.100.406	1.0	40.6	7.2	-	6.95	4.25	3.45	43	2.5	7
APG07.117.102	1.17	10.2	7.2	-	6.95	4.25	3.45	13	2.5	7
APG07.117.152	1.17	15.2	7.2	-	6.95	4.25	3.45	18	2.5	7
APG07.117.203	1.17	20.3	7.2	-	6.95	4.25	3.45	23	2.5	7
APG07.117.254	1.17	25.4	7.2	-	6.95	4.25	3.45	28	2.5	7
APG07.117.305	1.17	30.5	7.2	-	6.95	4.25	3.45	33	2.5	7
APG07.117.356	1.17	35.6	7.2	-	6.95	4.25	3.45	38	2.5	7
APG07.117.406	1.17	40.6	7.2	-	6.95	4.25	3.45	43	2.5	7

Sipariş Örneği/Ordering Example/Bestellbeispiel  
1 ad./pcs./stück APG07.079.102

## MINI CUT GROOVING

### KANAL AÇMA MİNİ CUT TAKIMLAR

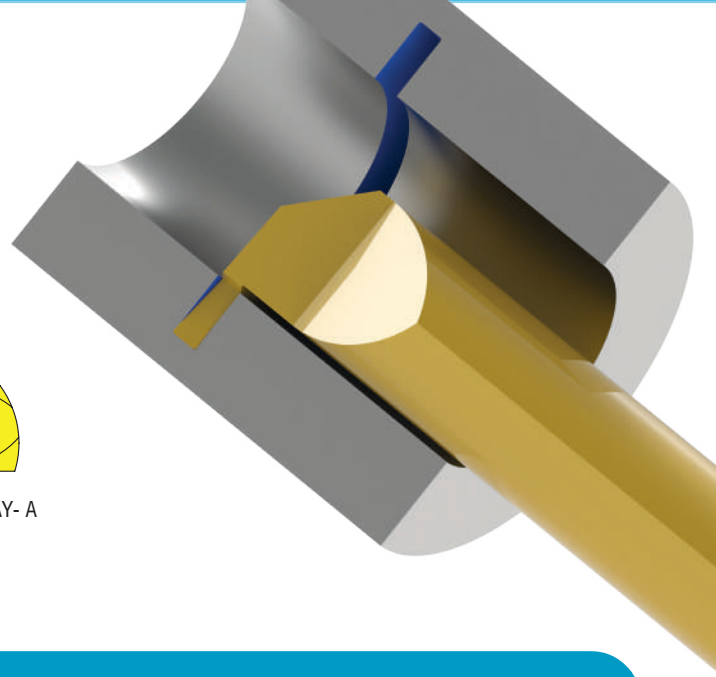
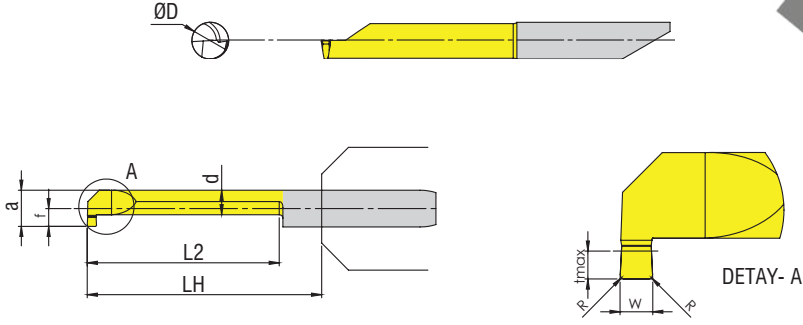

Ürün Kodu  
Product Code  
Artikelnummer

Takım Ölçüleri (mm)  
Dimension (mm)  
Abmessung (mm)

	W	L2	Ødmin	R	a	d	f	LH	tmax	ØD
APG07.150.102	1.5	10,2	7.2	-	6.95	4.25	3.45	13	2.5	7
APG07.150.152	1.5	15.2	7.2	-	6.95	4.25	3.45	18	2.5	7
APG07.150.203	1.5	20.3	7.2	-	6.95	4.25	3.45	23	2.5	7
APG07.150.254	1.5	25.4	7.2	-	6.95	4.25	3.45	28	2.5	7
APG07.150.305	1.5	30.5	7.2	-	6.95	4.25	3.45	33	2.5	7
APG07.150.356	1.5	35.6	7.2	-	6.95	4.25	3.45	38	2.5	7
APG07.150.406	1.5	40,6	7.2	-	6.95	4.25	3.45	43	2.5	7
APG07.157.102	1.57	10,2	7.2	-	6.95	4.25	3.45	13	2.5	7
APG07.157.152	1.57	15.2	7.2	-	6.95	4.25	3.45	18	2.5	7
APG07.157.203	1.57	20.3	7.2	-	6.95	4.25	3.45	23	2.5	7
APG07.157.254	1.57	25.4	7.2	-	6.95	4.25	3.45	28	2.5	7
APG07.157.305	1.57	30.5	7.2	-	6.95	4.25	3.45	33	2.5	7
APG07.157.356	1.57	35.6	7.2	-	6.95	4.25	3.45	38	2.5	7
APG07.157.406	1.57	40,6	7.2	-	6.95	4.25	3.45	43	2.5	7
APG07.198.102	1.98	10,2	7.2	-	6.95	4.25	3.45	13	2.5	7
APG07.198.152	1.98	15.2	7.2	-	6.95	4.25	3.45	18	2.5	7
APG07.198.203	1.98	20.3	7.2	-	6.95	4.25	3.45	23	2.5	7
APG07.198.254	1.98	25.4	7.2	-	6.95	4.25	3.45	28	2.5	7
APG07.198.305	1.98	30.5	7.2	-	6.95	4.25	3.45	33	2.5	7
APG07.198.356	1.98	35.6	7.2	-	6.95	4.25	3.45	38	2.5	7

Sipariş Örneği/Ordering Example/Bestellbeispiel  
1 ad./pcs./stück APG07.117.102



## MINI CUT GROOVING

### KANAL AÇMA MİNİ CUT TAKIMLAR

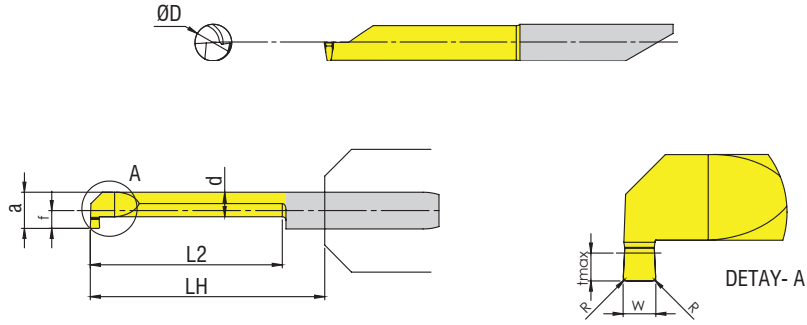

Ürün Kodu  
Product Code  
Artikelnummer

Takım Ölçüleri (mm)  
Dimension (mm)  
Abmessung (mm)

	W	L2	Ødmin	R	a	d	f	LH	tmax	ØD
APG07.200.102	2.0	10.2	7.2	-	6.95	4.25	3.45	13	2.5	7
APG07.200.152	2.0	15.2	7.2	-	6.95	4.25	3.45	18	2.5	7
APG07.200.203	2.0	20.3	7.2	-	6.95	4.25	3.45	23	2.5	7
APG07.200.254	2.0	25.4	7.2	-	6.95	4.25	3.45	28	2.5	7
APG07.200.305	2.0	30.5	7.2	-	6.95	4.25	3.45	33	2.5	7
APG07.200.356	2.0	35.6	7.2	-	6.95	4.25	3.45	38	2.5	7
APG10.100.305	1.0	30.5	10.5	-	9.95	5.45	4.95	33.0	4.0	10
APG10.100.508	1.0	50.8	10.5	-	9.95	5.45	4.95	53.0	4.0	10
APG10.200.305	2.0	30.5	10.5	-	9.95	5.45	4.95	33.0	4.0	10
APG10.200.508	2.0	50.8	10.5	-	9.95	5.45	4.95	53.0	4.0	10
APG10.300.305	3.0	30.5	10.5	-	9.95	5.45	4.95	33.0	4.0	10
APG10.300.508	3.0	50.8	10.5	-	9.95	5.45	4.95	53.0	4.0	10

Sipariş Örneği/Ordering Example/Bestellbeispiel  
1 ad./pcs./stück APG07.200.102

## MINI CUT GROOVING

### KANAL AÇMA MİNİ CUT TAKIMLAR

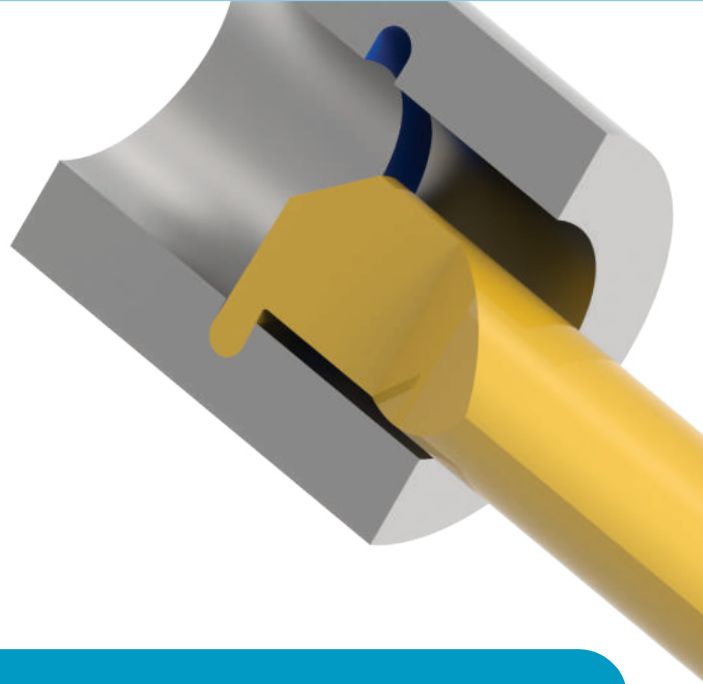
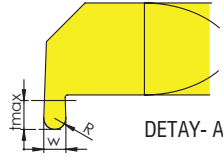
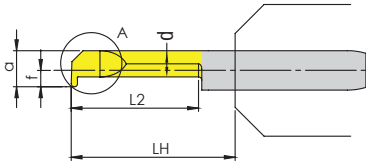
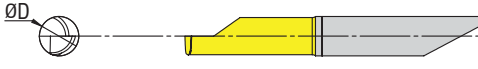

Ürün Kodu  
Product Code  
Artikelnummer

Takım Ölçüleri (mm)  
Dimension (mm)  
Abmessung (mm)

	W	L2	Ødmin	R	a	d	f	LH	tmax	ØD
APG04.100.152.R050	1.0	15.2	4.2	0.5	3.95	2.95	1.95	18.0	0.8	4
APG04.117.152.R0585	1.17	15.2	4.2	0.585	3.95	2.95	1.95	18.0	0.8	4
APG05.100.203.R050	1.0	20.3	5.2	0.5	4.95	3.75	2.45	23.0	1.0	5
APG05.117.203.R0585	1.17	20.3	5.2	0.585	4.95	3.75	2.45	23.0	1.0	5
APG05.150.203.R075	1.5	20.3	5.2	0.75	4.95	3.75	2.45	23.0	1.0	5
APG05.1574.203.R0787	1.574	20.3	5.2	0.787	4.95	3.75	2.45	23.0	1.0	5
APG05.1626.203.R0813	1.626	20.3	5.2	0.813	4.95	3.75	2.45	23.0	1.0	5
APG05.198.203.R099	1.98	20.3	5.2	0.99	4.95	3.75	2.45	23.0	1.0	5
APG05.200.203.R100	2.0	20.3	5.2	1.0	4.95	3.75	2.45	23.0	1.0	5
APG06.100.254.R050	1.0	25.4	6.2	0.5	5.95	3.95	2.95	28.0	1.8	6
APG06.117.254.R0585	1.17	25.4	6.2	0.585	5.95	3.95	2.95	28.0	1.8	6
APG06.150.254.R075	1.5	25.4	6.2	0.75	5.95	3.95	2.95	28.0	1.8	6
APG06.1574.254.R0787	1.574	25.4	6.2	0.787	5.95	3.95	2.95	28.0	1.8	6
APG06.1626.254.R0813	1.626	25.4	6.2	0.813	5.95	3.95	2.95	28.0	1.8	6
APG06.198.254.R099	1.98	25.4	6.2	0.99	5.95	3.95	2.95	28.0	1.8	6
APG06.200.203.R100	2.0	20.3	6.2	1.0	5.95	3.95	2.95	23.0	1.8	6
APG06.200.254.R100	2.0	25.4	6.2	1.0	5.95	3.95	2.95	28.0	1.8	6
APG07.100.305.R050	1.0	30.5	7.2	0.5	6.95	4.25	3.45	33.0	2.5	7
APG07.117.305.R0585	1.17	30.5	7.2	0.585	6.95	4.25	3.45	33.0	2.5	7
APG07.150.305.R075	1.5	30.5	7.2	0.75	6.95	4.25	3.45	33.0	2.5	7
APG07.1574.305.R0787	1.574	30.5	7.2	0.787	6.95	4.25	3.45	33.0	2.5	7
APG07.1626.305.R0813	1.626	30.5	7.2	0.813	6.95	4.25	3.45	33.0	2.5	7
APG07.198.305.R099	1.98	30.5	7.2	0.99	6.95	4.25	3.45	33.0	2.5	7
APG07.200.305.R100	2.0	30.5	7.2	1.0	6.95	4.25	3.45	33.0	2.5	7

Sipariş Örneği/Ordering Example/Bestellbeispiel  
1 ad./pcs./stück APG04.100.152.R050





## MINI CUT THREADING

### DIŞ ÇEKME MINI CUT TAKIMLAR

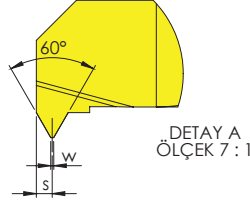
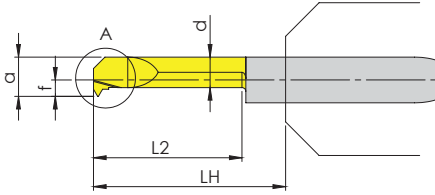
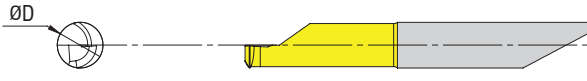

DETAY A  
ÖLÇEK 7 : 1

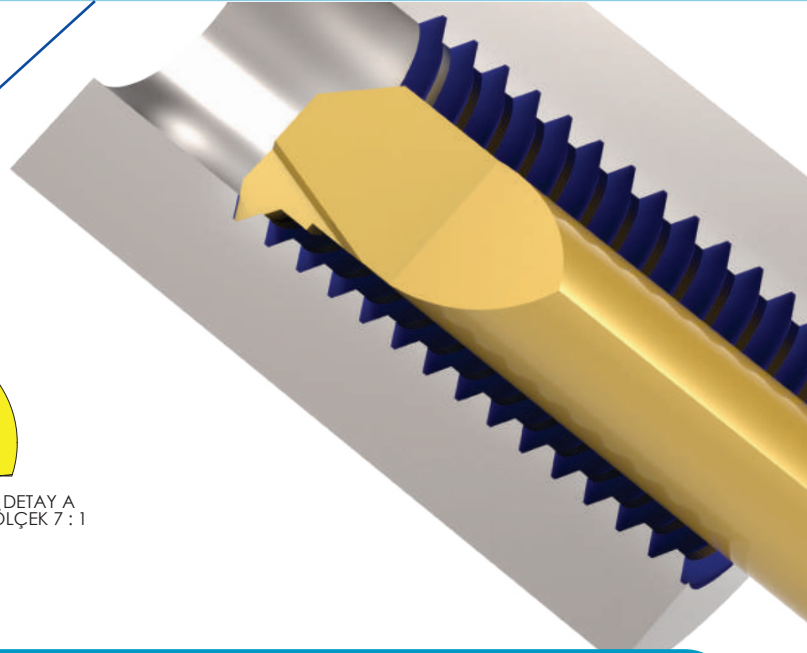

Ürün Kodu  
Product Code  
Artikelnummer

Takım Ölçüleri (mm)  
Dimension (mm)  
Abmessung (mm)

	PITCH		L2	ØDmin	a	d	f	LH	S	tmax	w	ØD
	min	maks										
APT.04.152.080	0.8	1.0	15.2	3.9	3.65	2.7	1.95	18.0	0.45	0.46	0.1	4
APT.04.152.050	0.5	0.7	15.2	4.2	3.95	2.95	1.95	18.0	0.35	0.4	0.06	4
APT.05.152.100	1.0	1.25	15.2	4.8	4.55	3.55	2.25	18.0	0.55	0.7	0.12	5
APT.05.203.100	1.0	1.25	20.3	4.8	4.55	3.55	2.25	23.0	0.55	0.7	0.12	5
APT.05.254.100	1.0	1.25	25.4	4.8	4.55	3.55	2.25	28.0	0.55	0.7	0.12	5
APT.05.152.075	0.75	1.0	15.2	5.1	4.85	3.65	2.40	18.0	0.45	0.57	0.09	5
APT.05.152.050	0.5	0.75	15.2	5.2	4.95	3.75	2.45	18.0	0.35	0.43	0.06	5
APT.06.152.125	1.0	1.25	15.2	6.2	5.95	3.95	2.95	18.0	0.55	0.7	0.12	6
APT.06.152.150	1.25	1.5	15.2	6.2	5.95	3.95	2.95	18.0	0.75	0.84	0.16	6
APT.06.203.125	1.25	1.5	20.3	6.2	5.95	3.95	2.95	23.0	0.75	0.84	0.16	6
APT.06.254.125	1.25	1.5	25.4	6.2	5.95	3.95	2.95	28.0	0.75	0.84	0.16	6
APT.06.152.175	1.5	1.75	15.2	6.2	5.95	3.95	2.95	18.0	0.8	0.98	0.18	6
APT.06.203.175	1.5	1.75	20.3	6.2	5.95	3.95	2.95	23.0	0.8	0.98	0.18	6
APT.06.254.175	1.5	1.75	25.4	6.2	5.95	3.95	2.95	28.0	0.8	0.98	0.18	6

Sipariş Örneği/Ordering Example/Bestellbeispiel  
1 ad./pcs./stück APT.04.152.080

## MINI CUT FACE GROOVING ALIN KANAL AÇMA MİNİ CUT TAKIMLAR

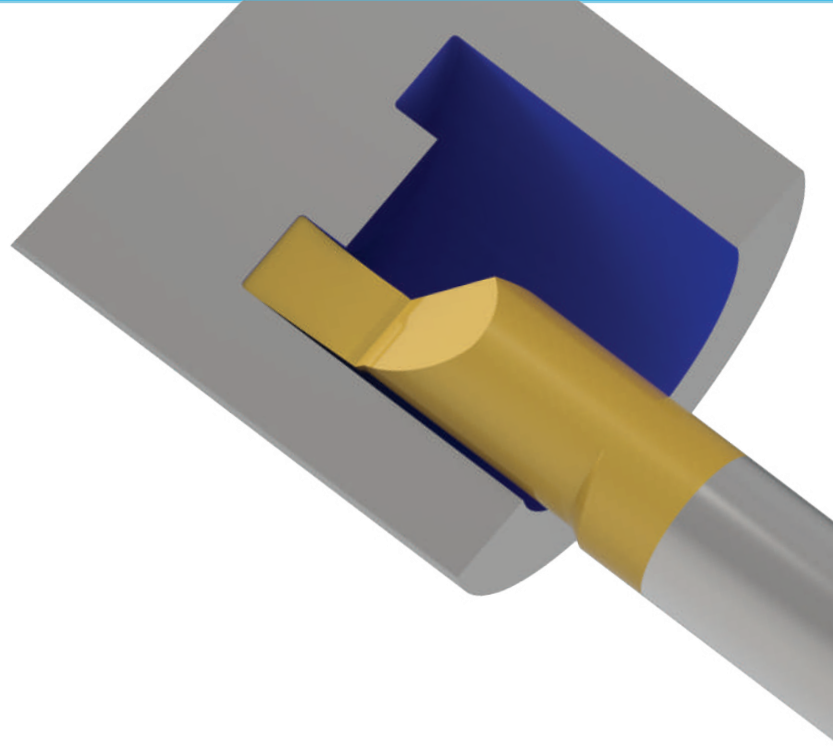
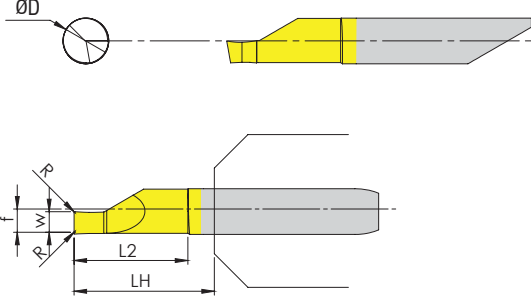

Ürün Kodu  
Product Code  
Artikelnummer

Takım Ölçüleri (mm)  
Dimension (mm)  
Abmessung (mm)

	W	L2	R	f	LH	tmax	ØD
APFGT06.152.0787	0.787	15.2	0.05	2.95	18.0	1.8	6
APFGT06.152.1000	1.0	15.2	0.05	2.95	18.0	2.0	6
APFGT06.152.1500	1.5	15.2	0.05	2.95	18.0	3.0	6
APFGT06.152.1000	1.0	15.2	0.15	2.95	18.0	2.0	6
APFGT06.152.1168	1.168	15.2	0.15	2.95	18.0	2.34	6
APFGT06.152.1500	1.5	15.2	0.15	2.95	18.0	3.0	6
APFGT06.152.1575	1.575	15.2	0.15	2.95	18.0	3.15	6
APFGT06.152.1981	1.981	15.2	0.15	2.95	18.0	3.95	6
APFGT06.152.2000	2.0	15.2	0.15	2.95	18.0	4.0	6
APFGT06.152.2388	2.388	15.2	0.15	2.95	18.0	5.0	6
APFGT06.152.2500	2.5	15.2	0.15	2.95	18.0	5.0	6
APFGT06.152.3000	3.0	15.2	0.15	2.95	18.0	6.0	6
APFGT06.152.3175	3.175	15.2	0.15	2.95	18.0	6.0	6



# SPECIAL MINI CUT TOOLS

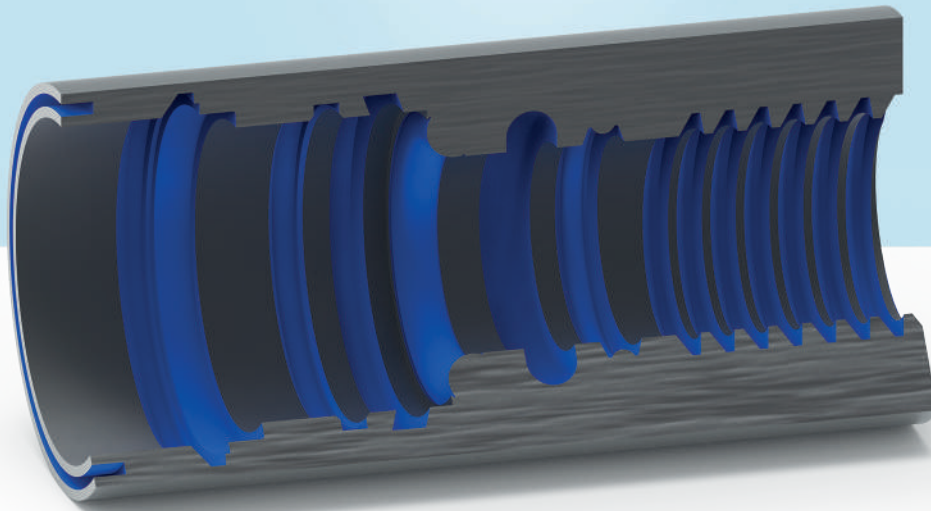

MINI CUT TAKIMLARI BİLGİ ALMA FORMU  
INFORMATION REQUEST FORM FOR MINI CUT TOOLS  
INFORMATIONSFÖRMULAR FÜR MINI CUT WERKZEUGE

TOOL TYPE	TOOL DIMENSIONS					
BORING <input type="checkbox"/>	ØD	ØDmin	L	RE	TMAX	
GROOVING <input type="checkbox"/>				RE - R1,R2	W	TMAX
FACE GROOVING <input type="checkbox"/>				RE - R1,R2	W	TMAX
THREADING <input type="checkbox"/>				CHOOSE THREADING TYPE		
				METRIC <input type="checkbox"/>	NPT <input type="checkbox"/>	UNF/UNC <input type="checkbox"/>
				TRAPEZOIDAL <input type="checkbox"/>	WHITWORTH <input type="checkbox"/>	ACME <input type="checkbox"/>

# TORX - ALYAN / PUNCH - KAZIMA TAKIMLARI

TORX-ALLEN / PUNCH - BROACH SET  
TORX WINKELSCHRAUBENDEHER WERKZEUGE

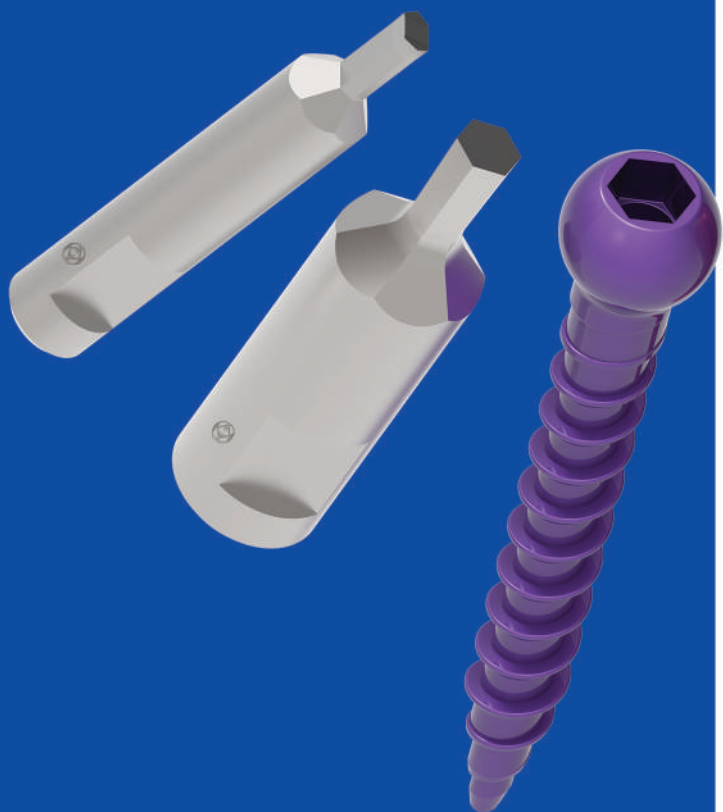



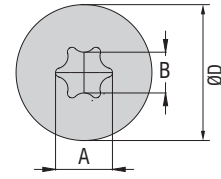
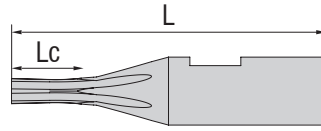

Ürün Kodu  
 Product Code  
 Artikelnummer

Soket Numarası  
 Socket Number  
 Seriennummer

Uç Ölçüleri (mm)  
 Insert Dimension (mm)  
 Abmessung (mm)

Ürün Kodu Product Code Artikelnummer	Soket Numarası Socket Number Seriennummer	Uç Ölçüleri (mm) Insert Dimension (mm) Abmessung (mm)			
		ØD	L2	A	B
APT-X-006	T6	8	1.82	1.75	1.27
APT-X-008	T8	8	3.05	2.4	1.75
APT-X-010	T10	8	3.56	2.8	2.05
APT-X-015	T15	8	3.81	3.35	2.4
APT-X-020	T20	8	4.07	3.95	2.85
APT-X-025	T25	10	4.45	4.5	3.25
APT-X-030	T30	10	4.95	5.6	4.05
APT-X-040	T40	10	5.59	6.75	4.85
APT-X-045	T45	10	6.22	7.93	5.64
APT-X-050	T50	10	6.48	8.95	6.45



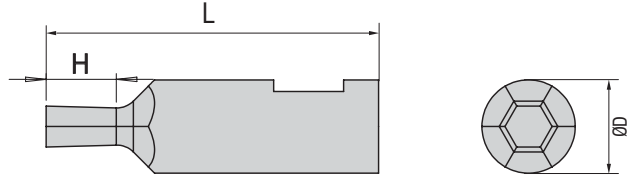

Ürün Kodu  
Product Code  
Artikelnummer

Soket Numarası  
Socket Number  
Seriennummer

Uç Ölçüleri (mm)  
Insert Dimension (mm)  
Abmessung (mm)

ØD	L2	L
8	3	30
8	4	30
8	5	30
8	6	30
8	6	30
8	8	30
8	9	30
8	10	30
8	11	30
8	12	30
8	12	30
10	12	45
10	16	45
10	18	45
10	20	45

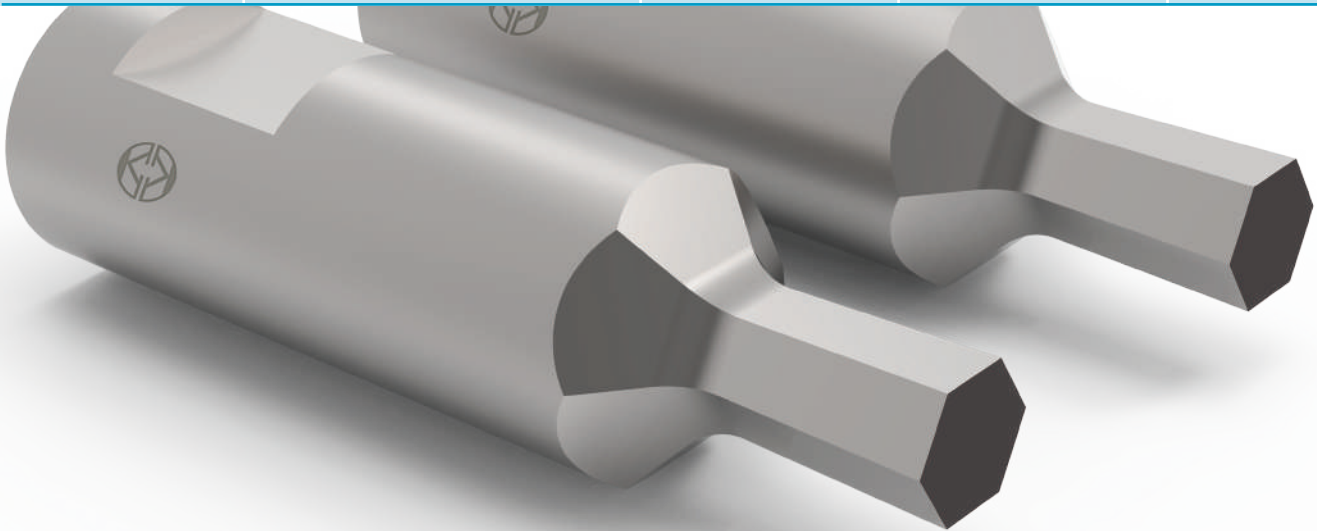

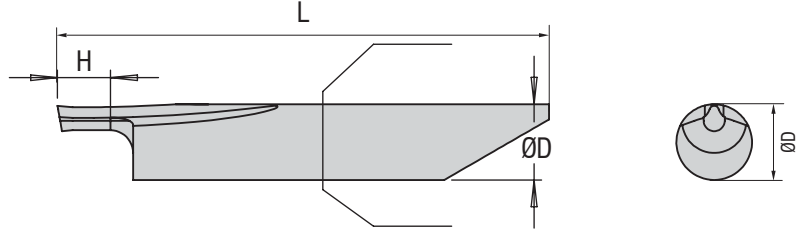

Ürün Kodu Product Code Artikelnummer	Soket Numarası Socket Number Seriennummer	Uç Ölçüleri (mm) Insert Dimension (mm) Abmessung (mm)	
		ØD	L2
AKTX-006	6	6	3.0
AKTX-008	8	6	4.0
AKTX-010	10	6	4.5
AKTX-015	15	6	4.5
AKTX-020	20	6	5.0
AKTX-030	30	6	6.0
AKTX-040	40	6	6.5
AKTX-045	45	6	7.0

Ürün Kodu Product Code Artikelnummer	Soket Numarası Socket Number Seriennummer	Uç Ölçüleri (mm) Insert Dimension (mm) Abmessung (mm)	
		ØD	L2
AKTX-050	50	6	7.0
AKTX-055	55	6	7.5
AKTX-060	60	6	9.0
AKTX-070	70	6	9.5
AKTX-080	80	6	10.5
AKTX-090	90	6	11.5
AKTX-100	100	6	12.0

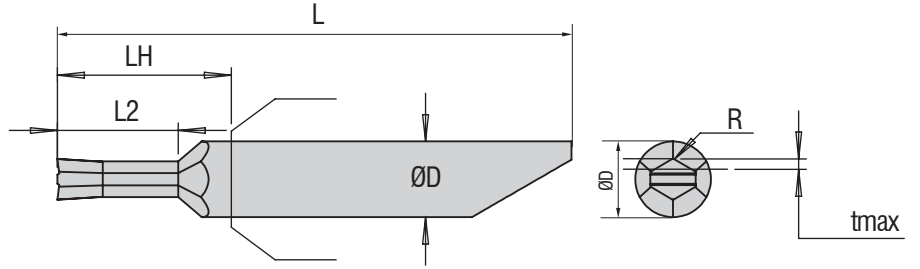
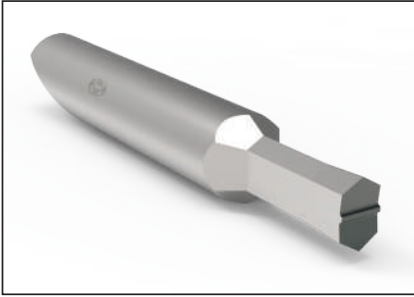

Ürün Kodu Product Code Artikelnummer	Soket Numarası Socket Number Seriennummer	Uç Ölçüleri (mm) Insert Dimension (mm) Abmessung (mm)				
		ØD	r	L2	LH	Tmax
AKHX-001-001	1	6	0.05	2	4	0.3
AKHX-002-002	2	6	0.05	3	5	0.6
AKHX-003-003	3	6	0.05	6	8	1
AKHX-004-006	4-6	6	0.10	8	10	1
AKHX-007-012	7-12	8	0.15	12	15	1.5
AKHX-013-018	13-18	8	0.20	15	17	2

COMING SOON!



NEW!  
S-DRILL







 **AKKO®**



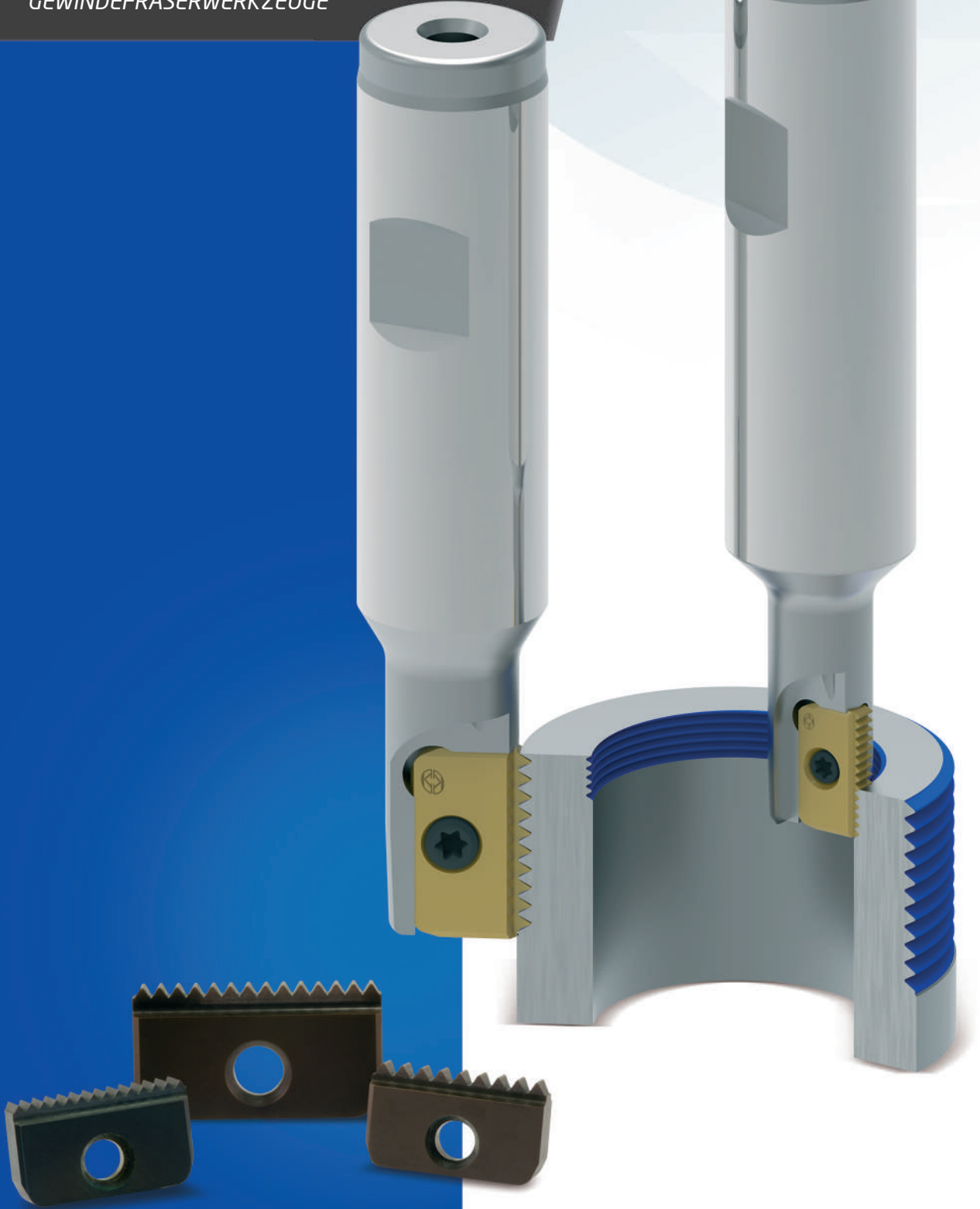

[www.akko.com.tr](http://www.akko.com.tr)

# DİŞ AÇMA FREZELEME TAKIMLARI VE UÇLARI

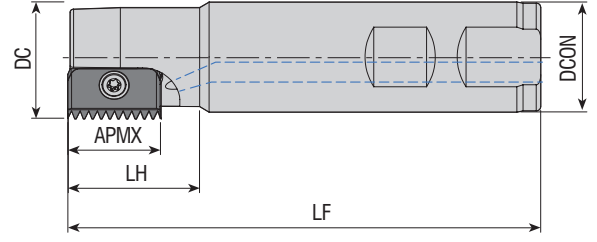
THREAD MILLING INSERTS AND TOOLHOLDER  
GEWINDEFÄSERWERKZEUGE





Takım Kodu Ordering Code Bestell-Bezeichnung	Stok Stock Lager	Takım Ölçüleri (mm) Dimension (mm) Abmessung (mm)						Kesici Uç Insert Wendeschneidplatte	Yedek Parçaları / Spare Parts / Ersatzteile	
		DC	ZEFP	DCON	LF	LH	APMX		Sıkma Vidası Screw Schraube	Tork Anahtar Torx Key Torx-Schlüssel
ATM-C14-D14-W20-L100-Z01-H	●	14	1	20	100	25	14			82-T08
ATM-C21-D18-W20-L100-Z01-H	●	18	1	20	100	30	21			
ATM-C21-D21-W25-L125-Z01-H	●	21	1	25	125	40	21			4015-M4x11
ATM-C21-D25-W20-L125-Z01-H	●	25	1	20	125	30	21			
ATM-C21-D28-W25-L90-Z01-H	●	28	1	25	90	30	21			
ATM-C21-D38-W32-L90-Z03-H	●	38	3	32	90	30	21			
ATM-C21-D38-W32-L120-Z03-H	●	38	3	32	120	30	21			
ATM-C21-D43-W32-L90-Z03-H	●	43	3	32	90	30	21		1020-M5x14	80-T20
ATM-C30-D29-W25-L150-Z01-H	●	29	1	25	150	50	30			

CPT Ucuna Uygunur. / Compatible with CPT Insert. / Kompatibel mit CPT Wendeplatten.

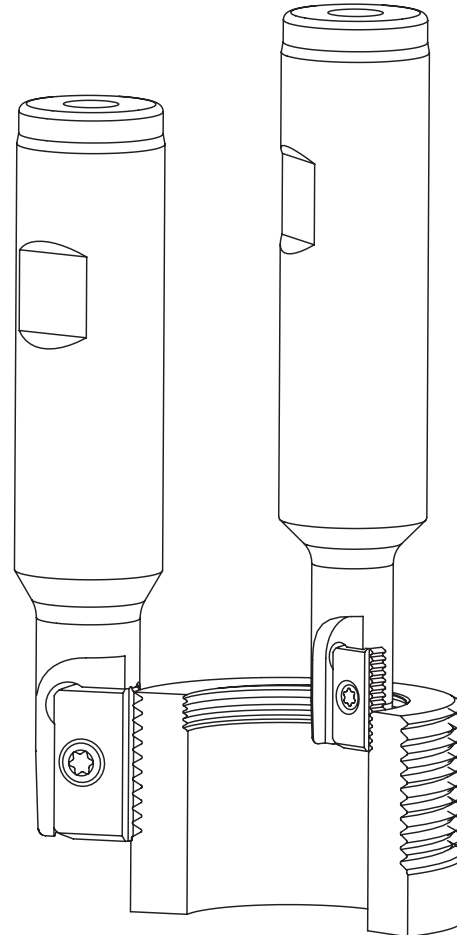

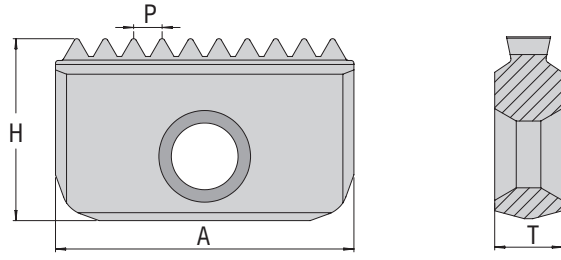
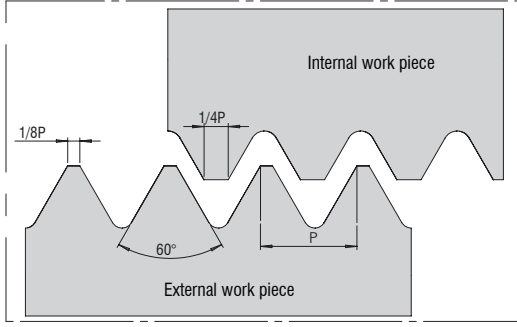

Ürün Kodu Product Code Artikelnummer	Insert Tipi Insert Type Wendeplatten Typ A	Takım Ölçüleri (mm) Dimension (mm) Abmessung (mm)		
		Adım Pitch Wendeplatten Typ	H	T
ADTI.14.050	C14	0.5	7.5	3.1
ADTI.14.075		0.75	7.5	3.1
ADTE.14.075		0.75	7.5	3.1
ADTI.14.100		1.00	7.5	3.1
ADTE.14.100		1.00	7.5	3.1
ADTI.14.125		1.25	7.5	3.1
ADTE.14.125		1.25	7.5	3.1
ADTI.14.150		1.50	7.5	3.1
ADTE.14.150		1.50	7.5	3.1
ADTI.14.175		1.75	7.5	3.1
ADTE.14.175		1.75	7.5	3.1
ADTI.14.200		2.00	7.5	3.1
ADTE.14.200		2.00	7.5	3.1
ADTI.14.250		2.50	7.5	3.1
ADTE.14.250		2.50	7.5	3.1

Ürün Kodu Product Code Artikelnummer	Insert Tipi Insert Type Wendeplatten Typ A	Takım Ölçüleri (mm) Dimension (mm) Abmessung (mm)		
		Adım Pitch Wendeplatten Typ (P)	H	T
ADTI.21.100	C21	1.00	12	4.7
ADTE.21.100		1.00	12	4.7
ADTI.21.150		1.50	12	4.7
ADTE.21.150		1.50	12	4.7
ADTI.21.175		1.75	12	4.7
ADTI.21.200		2.00	12	4.7
ADTE.21.200		2.00	12	4.7
ADTI.21.250		2.50	12	4.7
ADTE.21.250		2.50	12	4.7
ADTI.21.300		3.00	12	4.7
ADTE.21.300		3.00	12	4.7
ADTI.21.350		3.5	12	4.7



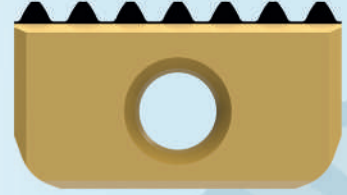
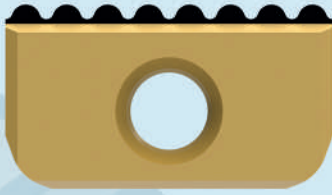

# SPECIAL THREADING MILLING TOOLS

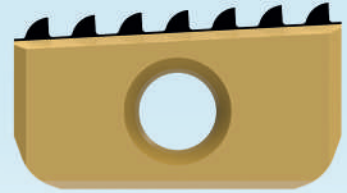
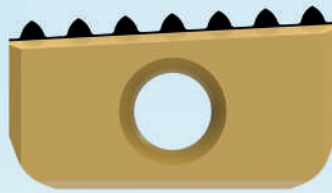
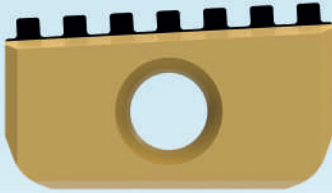

## DİŞ TARAĞI BİLGİ ALMA FORMU

INFORMATION FORM FOR SPECIAL THREAD MILLING INSERTS  
INFORMATIONSFÖRM FÜR SONDER GEWINDEFÄSERWERKZEUGE

Insert Type	Thread Type	Thread Pitch mm	Thread Profile
C 14	External <input type="checkbox"/> Internal <input type="checkbox"/> Nötr <input type="checkbox"/>		ISO <input type="checkbox"/> UN <input type="checkbox"/> WHIT <input type="checkbox"/> NPT <input type="checkbox"/> NPTF <input type="checkbox"/> BSPT <input type="checkbox"/> NPS <input type="checkbox"/> NPSF <input type="checkbox"/> PG <input type="checkbox"/>
C 21	External <input type="checkbox"/> Internal <input type="checkbox"/> Nötr <input type="checkbox"/>		ISO <input type="checkbox"/> UN <input type="checkbox"/> WHIT <input type="checkbox"/> NPT <input type="checkbox"/> NPTF <input type="checkbox"/> BSPT <input type="checkbox"/> NPS <input type="checkbox"/> NPSF <input type="checkbox"/> PG <input type="checkbox"/>

# SEGMAN UÇLARI VE TAKIMLARI

RING INSERTS AND TOOLHOLDERS  
*RINGEINSÄTZE UND WERKZEUGHALTER*

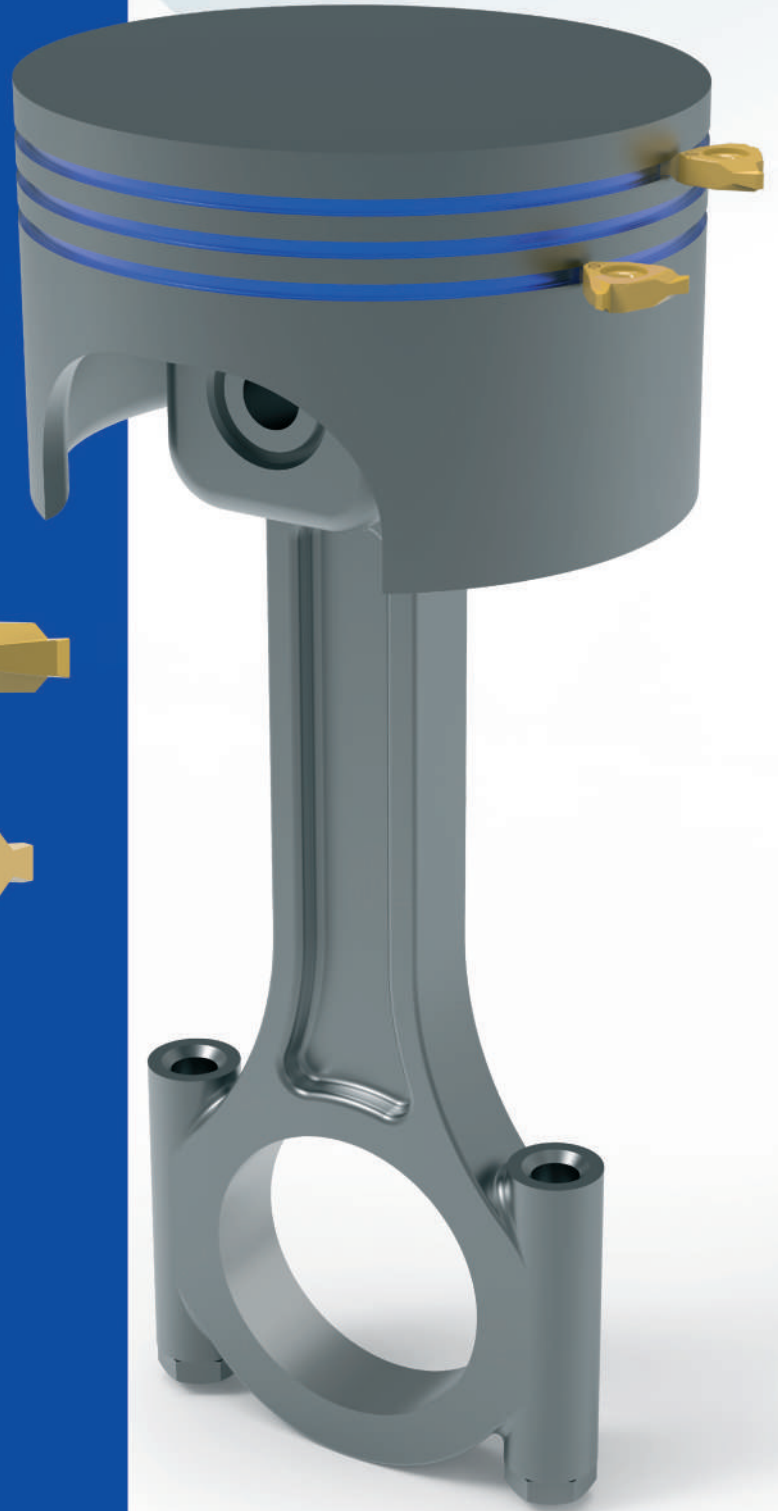

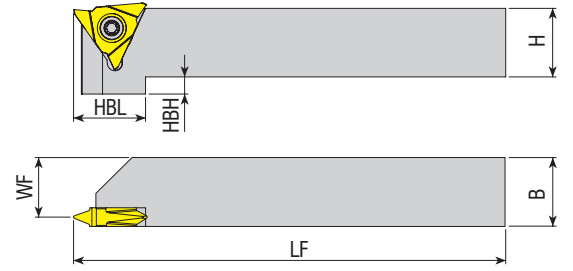

Takım Kodu Ordering Code Bestell-Bezeichnung	Stok Stock Lager		Takım Ölçüleri (mm) Dimension (mm) Abmessung (mm)					Kesici Uç Insert Wendeschneidplatte	Yedek Parçaları / Spare Parts / Ersatzteile		
	R	L	H	B	WF	LF	HBL		HBH	Sıkma Vidası Screw Schraube	Tork Anahtar Torx Key Torx-Schlüssel
ADKT-T12P-R/L-1616-T5	●	●	16	16	13.50	125	21	5	T12...	1020-M5x14	80-T20
ADKT-T12P-R/L-2020-T5	●	●	20	20	17.50	125	21	5			
ADKT-T12P-R/L-2525-T5	●	●	25	25	22.50	150	-	-			
ADKT-T12P-R/L-3232-T5	●	●	32	32	29.50	170	-	-			

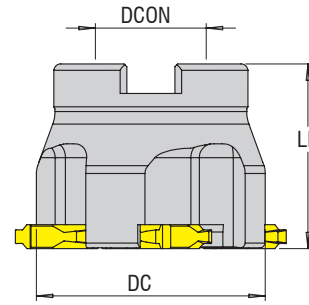

Takım Kodu Ordering Code Bestell-Bezeichnung	Takım Ölçüleri (mm) Dimension (mm) Abmessung (mm)					Kesici Uç Insert Wendeschneidplatte	Yedek Parçaları / Spare Parts / Ersatzteile	
	DC	ZEFP	DCON	LF	APMX		Sıkma Vidası Screw Schraube	Tork Anahtar Torx Key Torx-Schlüssel
ASFM-T12-D40x5.2-A22-Z04	40	2	16	40	-	T12...	1020-M5x14	80-T20
ASFM-T12-D50x5.2-A22-Z04	50	3	22	40	-			
ASFM-T12-D60x5.2-A22-Z04	60	4	22	40	-			

Sipariş Örneği/Ordering Example/Bestellbeispiel  
1 ad./pcs./stück ADKT-T12P-R/L-1616-T5

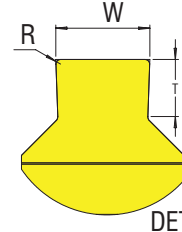
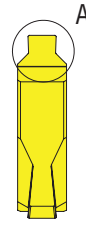
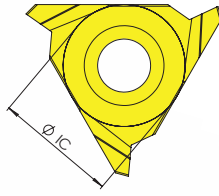

DETAY A

Ürün Kodu Product Code Artikelnummer	Stok Stock Lager	Uç Ölçüleri (mm) Insert Dimension (mm) Abmessung (mm)			
		IC	W	R	T
ASK-125-13	●	13	1.25	0.2	1.3
ASK-135-13	●	13	1.35	0.2	1.3
ASK-145-13	●	13	1.45	0.2	1.3
ASK-150-13	●	13	1.5	0.2	1.3
ASK-165-18	●	13	1.65	0.2	1.8
ASK-175-18	●	13	1.75	0.2	1.8
ASK-185-23	●	13	1.85	0.2	2.3
ASK-200-23	●	13	2	0.2	2.3
ASK-220-33	●	13	2.2	0.2	3.3
ASK-230-33	●	13	2.3	0.2	3.3
ASK-250-33	●	13	2.5	0.3	3.3
ASK-265-33	●	13	2.65	0.3	3.3
ASK-270-33	●	13	2.7	0.3	3.3
ASK-280-33	●	13	2.8	0.3	3.3
ASK-300-33	●	13	3	0.3	3.3
ASK-320-33	●	13	3.2	0.3	3.3
ASK-330-33	●	13	3.3	0.3	3.3
ASK-350-38	●	13	3.5	0.3	3.8
ASK-370-38	●	13	3.7	0.3	3.8
ASK-390-38	●	13	3.9	0.3	3.8
ASK-400-38	●	13	4	0.3	3.8

● Stokta / In Stock / Auf Lager ○ Stokta Yok / Non Stock Item / Kein Lagerartikel, Lieferzeit auf Anfrage

Sipariş Örneği/Ordering Example/Bestellbeispiel  
1 ad./pcs./stück ASK-125-13



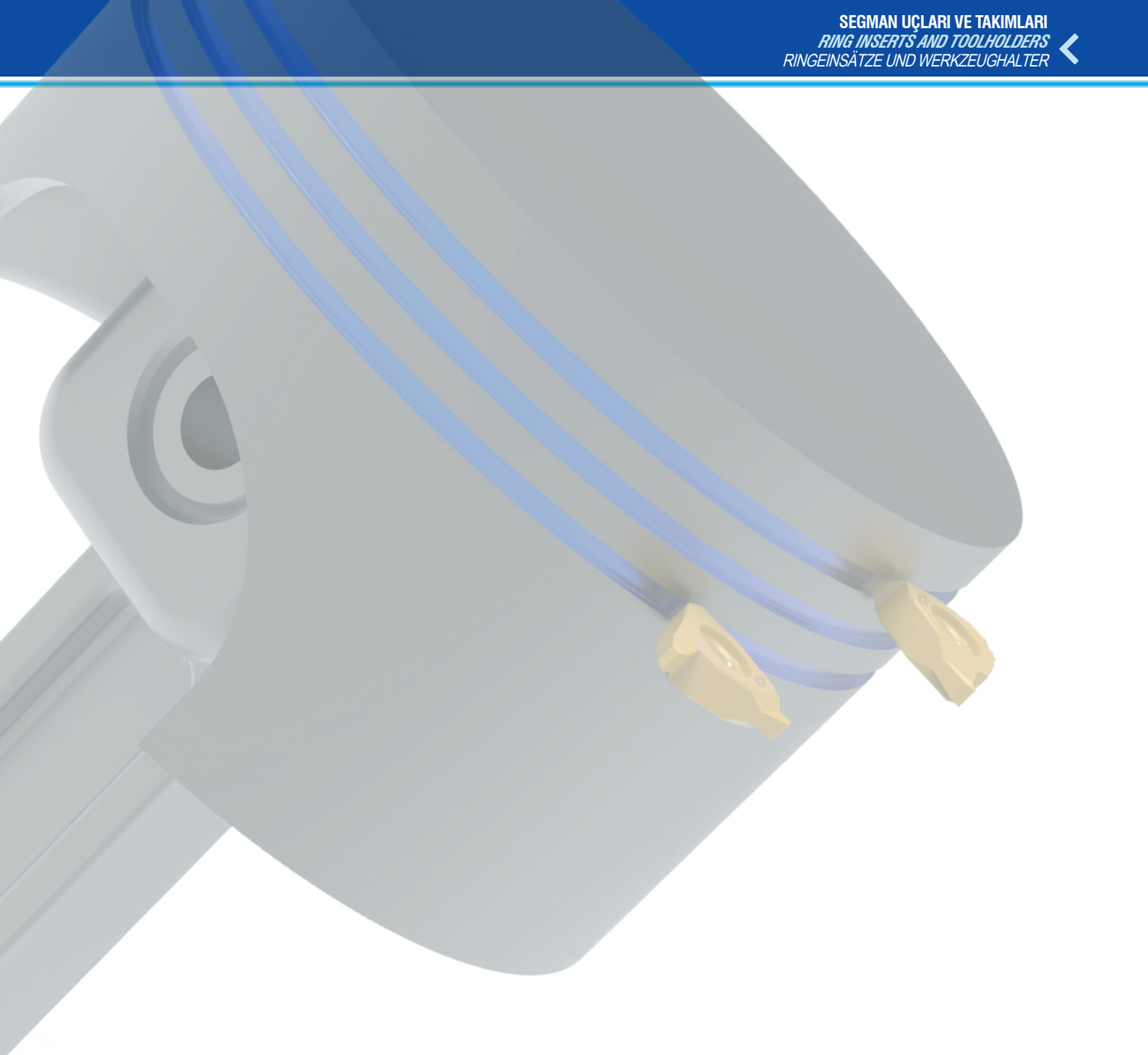

**SEGMAN UCU BİLGİ ALMA FORMU**

*INFORMATION REQUEST FORM FOR RING INSERTS*  
*INFORMATIONSFÖRMULAR FÜR RINGEINSÄTZE*

<b>W :</b>		A technical drawing showing the cross-section of a ring insert. The insert is a trapezoidal shape with a top width 'W' and a bottom width 'T'. The top corners are rounded with a radius 'R'. The bottom corners are also rounded with a radius 'R1'. The bottom edge is angled at a angle 'β'.
<b>R :</b>		
<b>R1 :</b>		
<b>β :</b>		



**AKKO**<sup>®</sup> *Cözümleri*  
**SOLUTIONS**  
**Lösungen**



**ÖZEL FORM KANAL AÇMA ÇÖZÜMÜ**  
**SPECIAL FORM GROOVING SOLUTIONS**  
**LÖSUNGEN ZUM EINSTECHDREHEN IN SONDERFORMEN**

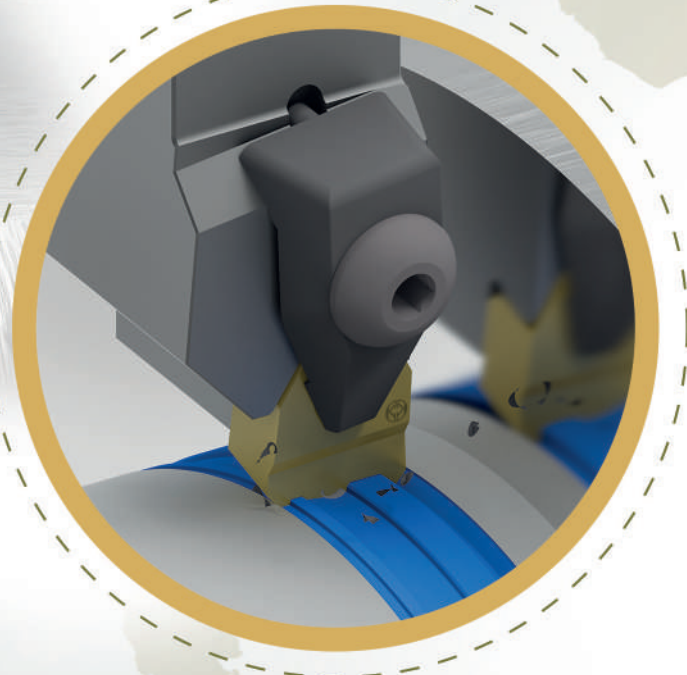
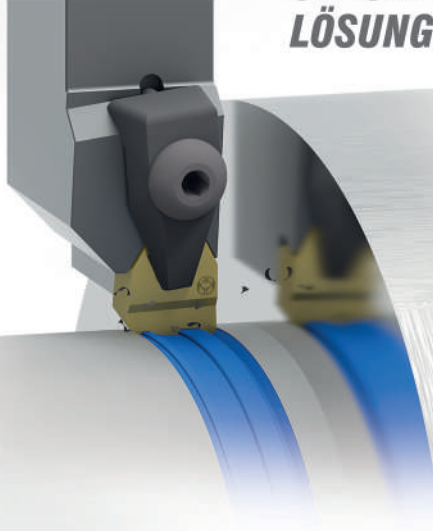

**ÖZEL TALAŞLI İMALAT ÇÖZÜMLERİ**  
**SPECIAL MACHINING SOLUTIONS**  
**SONDERLÖSUNGEN FÜR MASCHINEN**

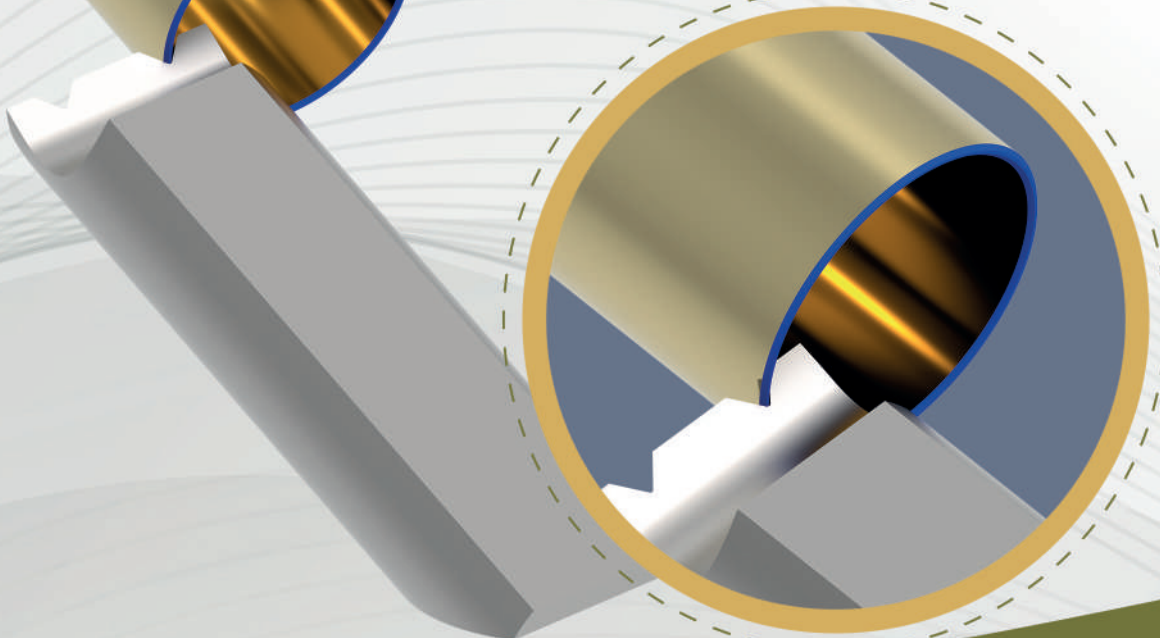



**ÖZEL FORM KANAL AÇMA ÇÖZÜMÜ**

**SPECIAL FORM GROOVING SOLUTIONS**

**LÖSUNGEN ZUM EINSTECHDREHEN IN SONDERFORMEN**

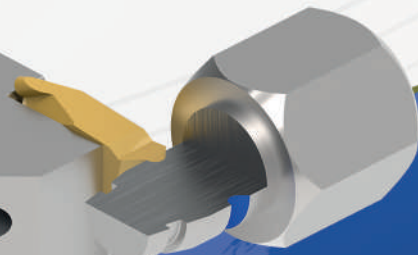
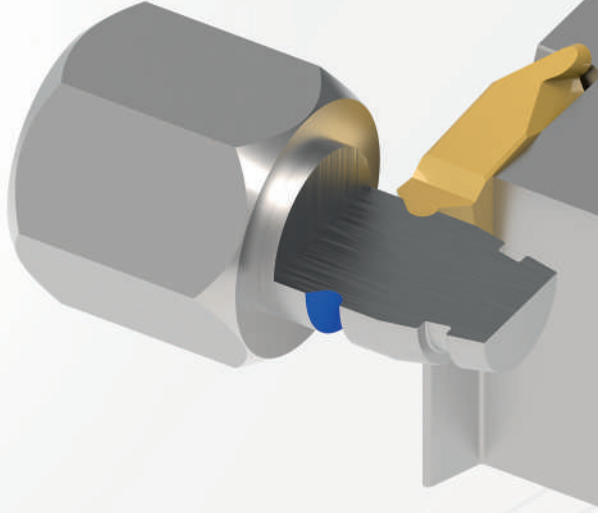
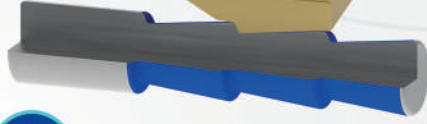





**AKKO**<sup>®</sup> SOLUTIONS  
Lösungen

*Cözümleri*



**ÖZEL FORM FREZELEME ÇÖZÜMLERİ**  
**SPECIAL FORM MILLING SOLUTIONS**  
**LÖSUNGEN FÜR SONDERFORMEN**  
**ZUM FRÄSEN**

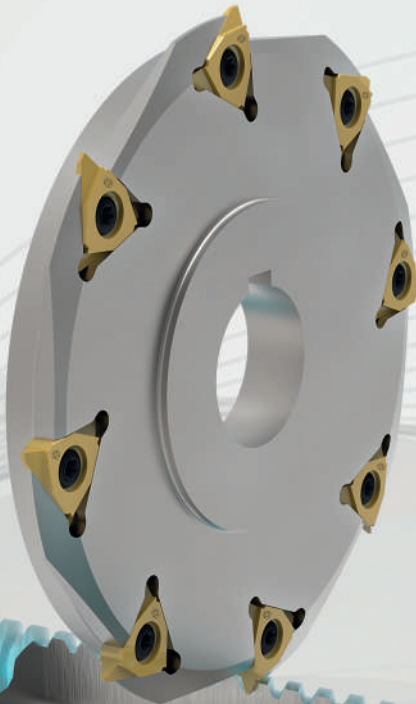
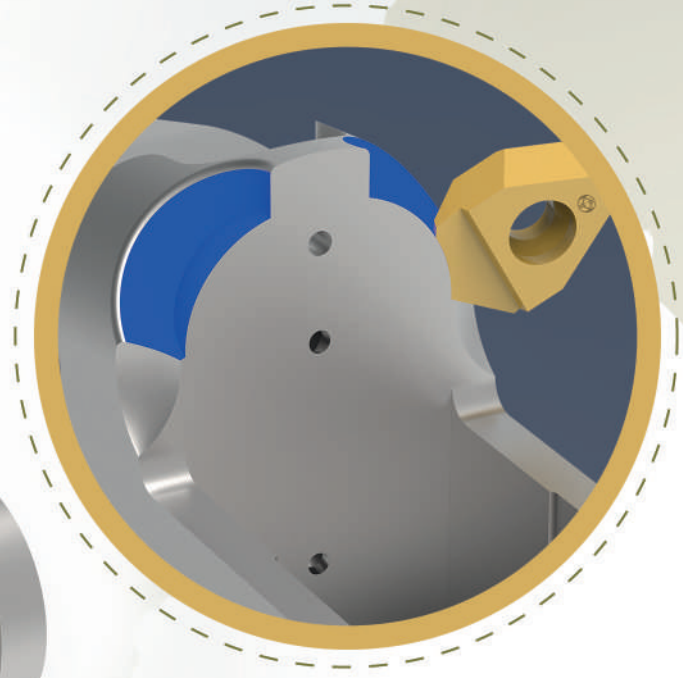
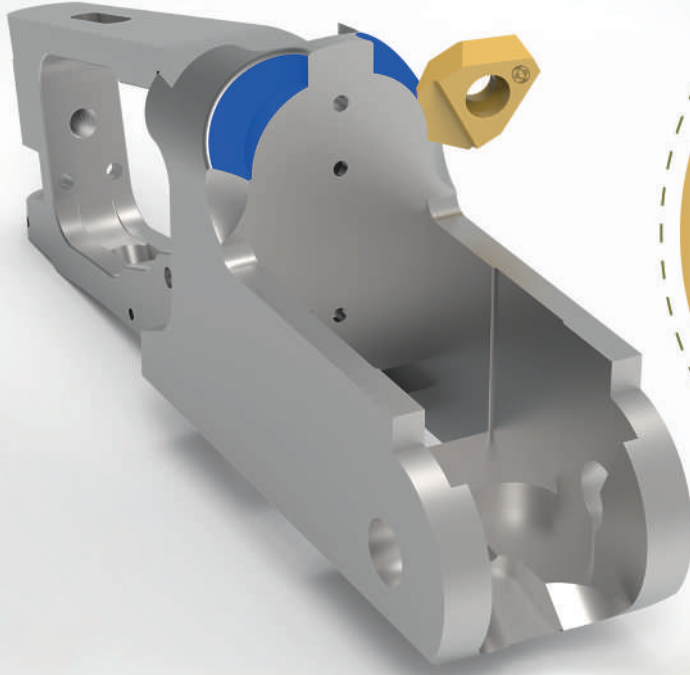

**SONSUZ DİŞLİ FREZELEME ÇÖZÜMLERİ**  
**SPECIAL MACHINING SOLUTIONS**  
**LÖSUNGEN ZUM FRÄSEN MIT**  
**ZAHNSTANGENGETRIEBE**





**ÖZEL FORM FREZELEME ÇÖZÜMLERİ**  
**SPECIAL FORM MILLING SOLUTIONS**  
**LÖSUNGEN FÜR SONDERFORMEN**  
**ZUM FRÄSEN**

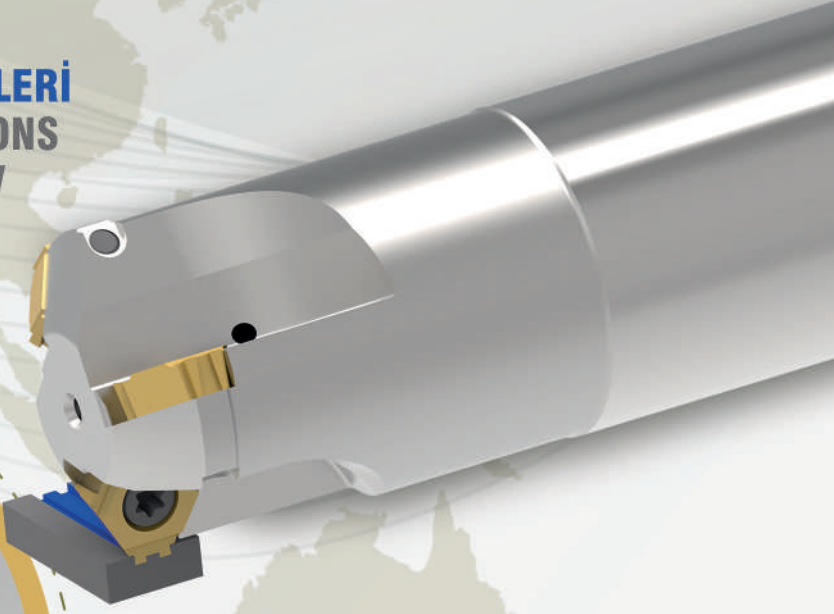
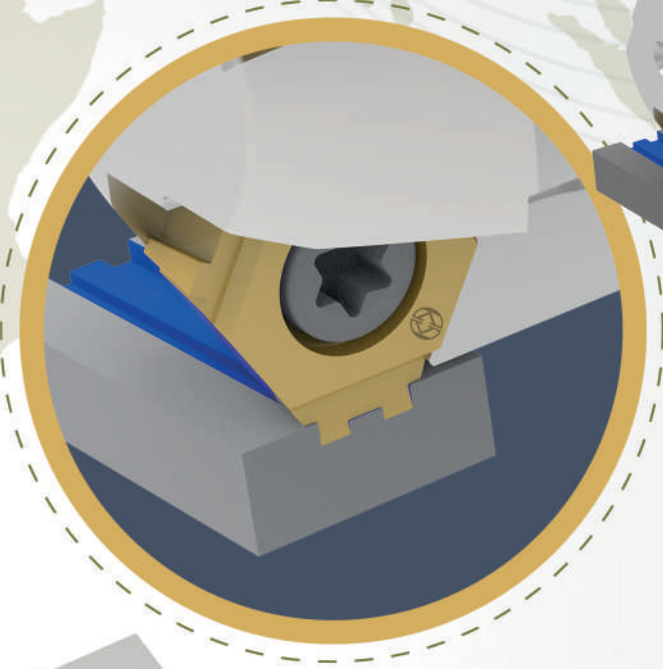

**ÖZEL SUPAP ÇÖZÜMLERİ**  
**SPECIAL VALVE SOLUTIONS**  
**SPEZIELLE VENTILLÖSUNGEN**





**HELİSEL ÖZEL FORM AÇMA ÇÖZÜMLERİ**  
**HELICAL SPECIAL FORMING SOLUTIONS**  
**HELIX SONDERFORMEBEARBEITUNGSLÖSUNGEN**



**ÖZEL TAKIMLANDIRMA ÇÖZÜMLERİ**  
**SPECIAL MACHINING SOLUTIONS**  
**SONDERLÖSUNGEN FÜR**  
**WERKZEUGHALTER**







**PETROL SONDAJ BORULARI DIŐ ÇEKME ÇÖZÜMLERİ**  
**SPECIAL FORM MILLING SOLUTIONS**  
**LÖSUNGEN MIT EINFÄDELWERKZEUG**  
**FÜR ÖL-GAS ROHREN**

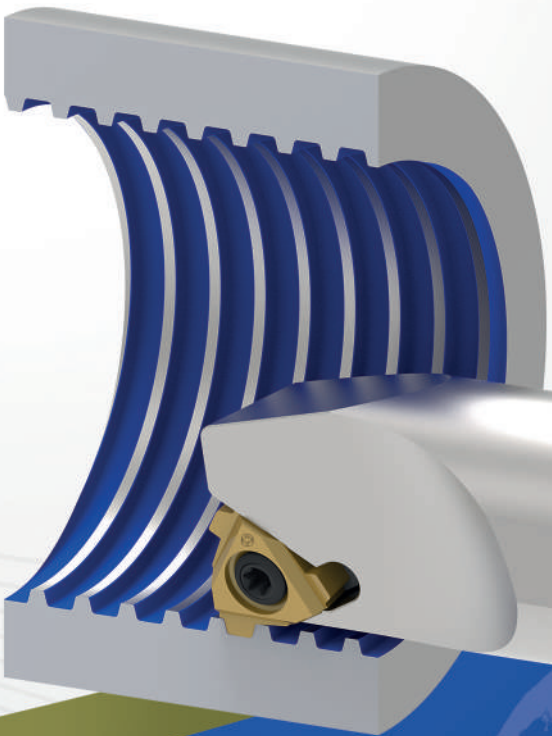
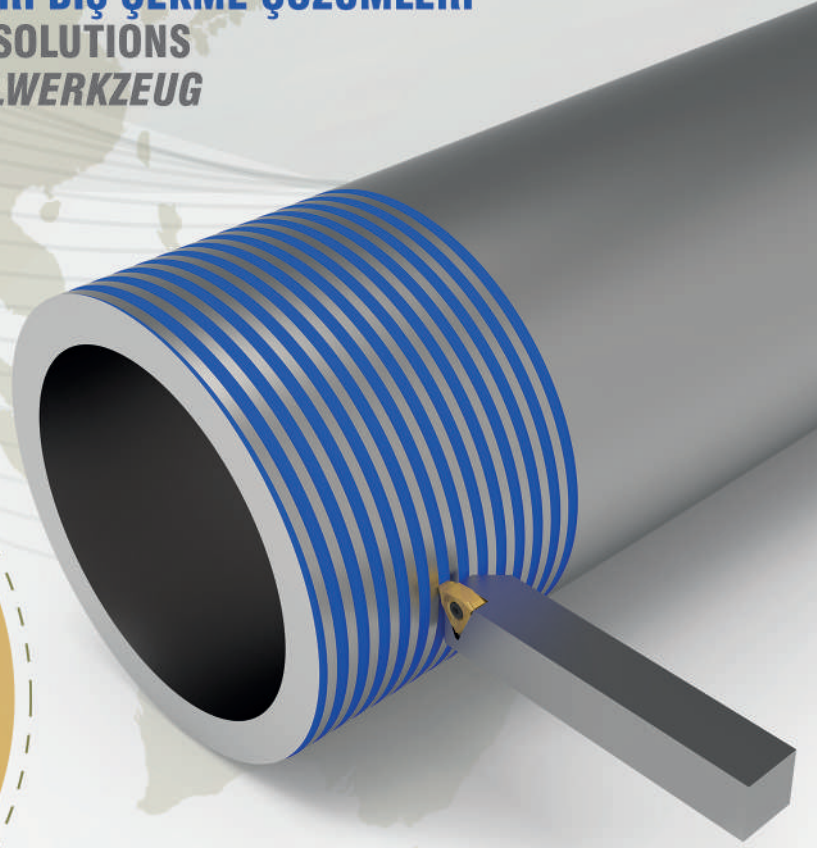

**ÖZEL FORM DIŐ ÇEKME ÇÖZÜMLERİ**  
**SPECIAL FORM THREADING SOLUTIONS**  
**LÖSUNGEN ZUM GEWINDEDREHEN**  
**VON SONDERFORMEN**



**AKKO**<sup>®</sup> SOLUTIONS  
Lösungen

*Cözümleri*



**STICK BLADE – KONVOID BLADE KONİK DIŞLİ AÇMA ÇÖZÜMLERİ**

**STICK BLADE – KONVOID BLADE BEVEL GEAR SOLUTIONS**

**LÖSUNGEN FÜR STICK BLADE- KONVOID BLADE MIT KEGELRADGETRIEBE**

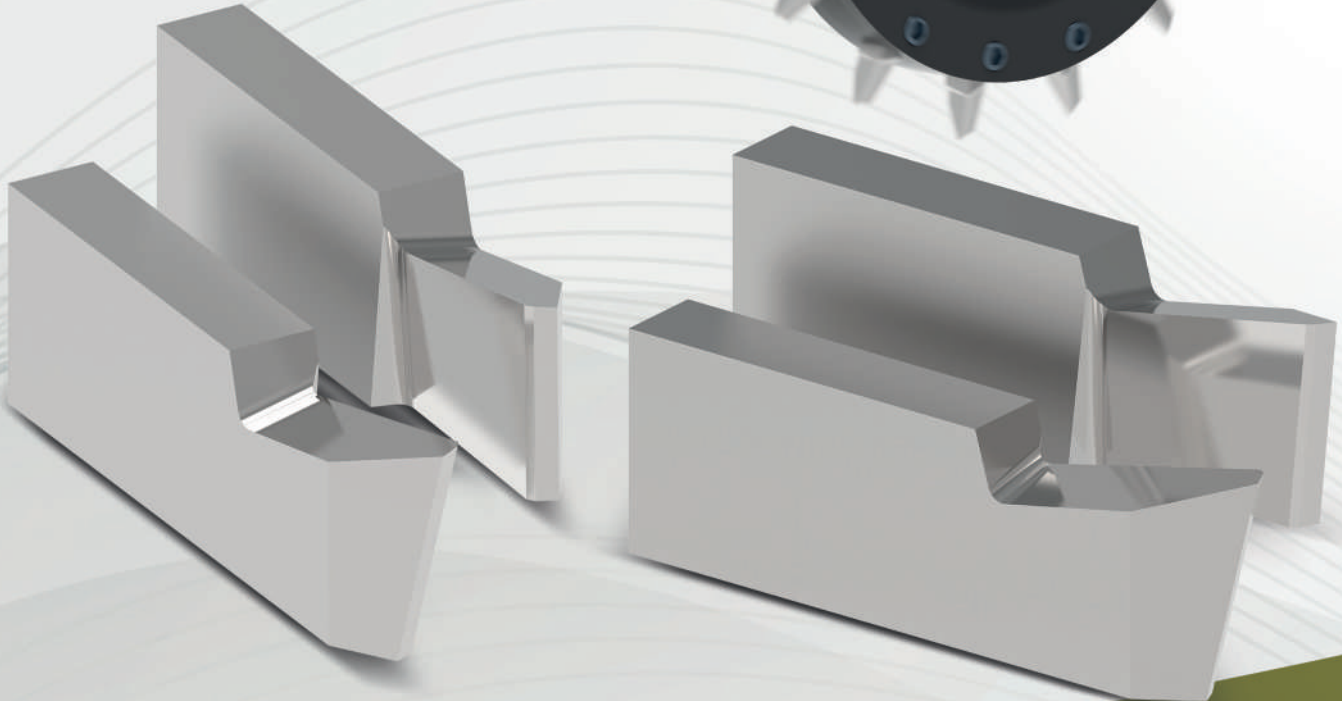
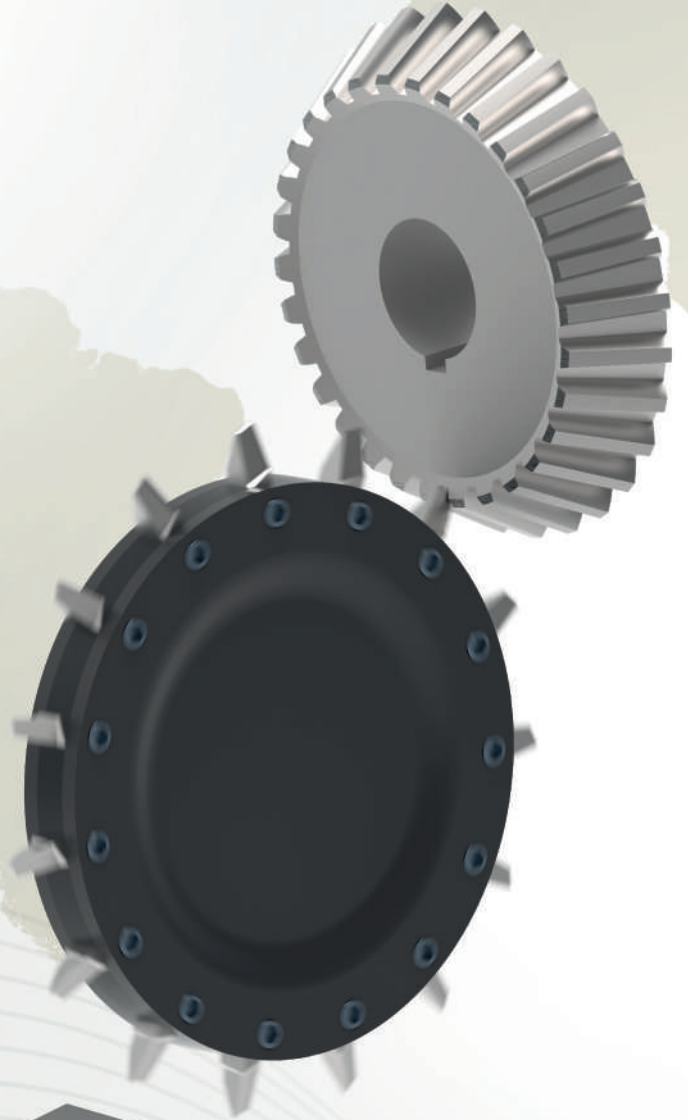
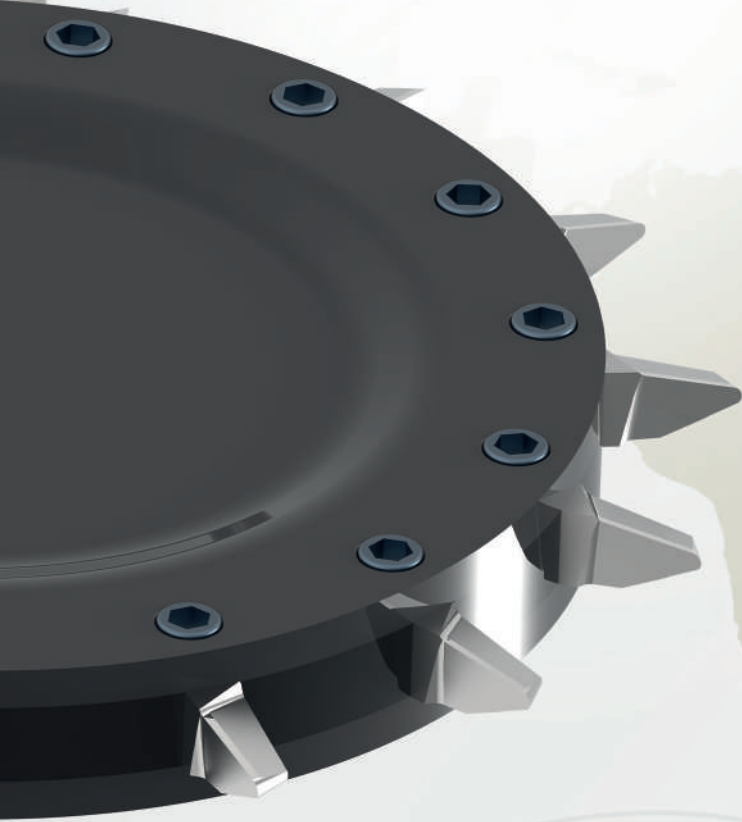





**ZİNCİR DİŞLİ BROŞ ÇÖZÜMLERİ**  
**CHAIN SPROCKETS BROACHING SOLUTIONS**  
**LÖSUNGEN MIT KETTENFORM**  
**ZUR NUTUNGSBEARBEITUNGEN**



**SONSUZ DİŞLİ TORNALAMA ÇÖZÜMLERİ**  
**WORM GEAR TURNING SOLUTIONS**  
**DREHLÖSUNGEN MIT ZAHNSTANGENGETRIEBE**

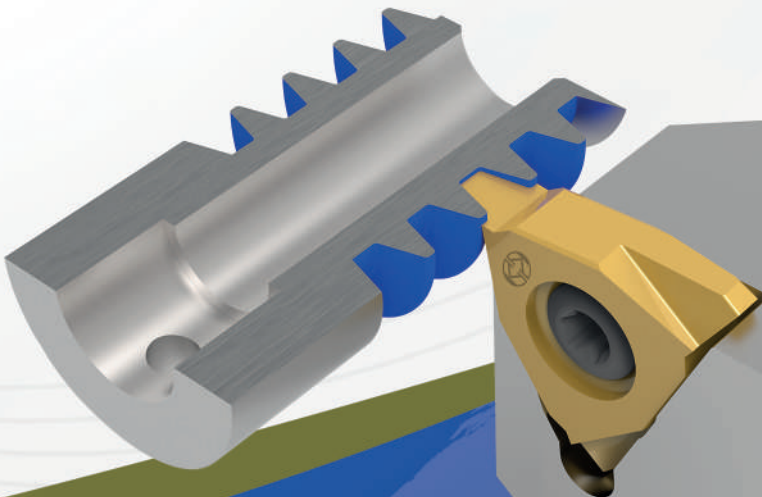

# SUPAP

**SUPAP YUVASI İŞLEME UÇLARI ve TAKIMLARI**  
VALVE SEAT INSERTS and TOOLHOLDERS  
WENDESCHNEIDPLATTEN UND WERKZEUGE FÜR  
VENTILSITZBEARBEITUNG

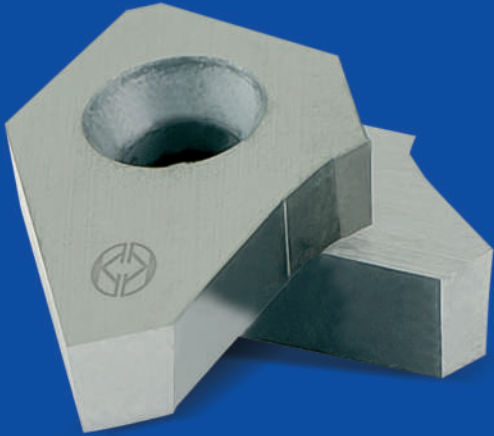

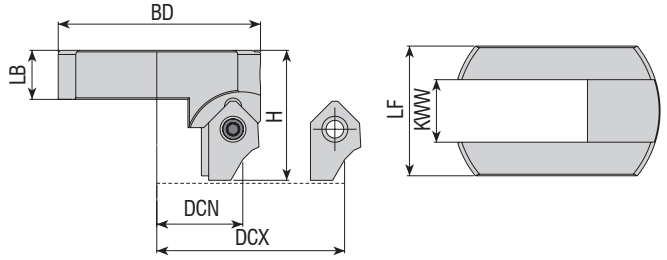

Takım Kodu Ordering Code Bestell-Bezeichnung	Stok Stock Lager	Takım Ölçüleri (mm) Dimension (mm) Abmessung (mm)						Kesici Uç Insert Wendeschneidplatte	Yedek Parçaları / Spare Parts / Ersatzteile			
		DCN DCX	BD	LB	H	KWW	LF		Sıkma Vidası Screw Schraube	Tork Anahtar Torx Key Torx-Schlüssel	Ayar Vidası Adjustable Einstellschraube	Anahtar Allen Key Innensechskantschlüssel
VST-B11-2842	●	28-42	29	9.5	28.5	12	25.0					
VST-B11-4058	●	40-58	39	9.5	25.0	12	25.0	<b>B11...</b>	3008-M3x8	80-T08	2725-M5x10	AAL-01-02

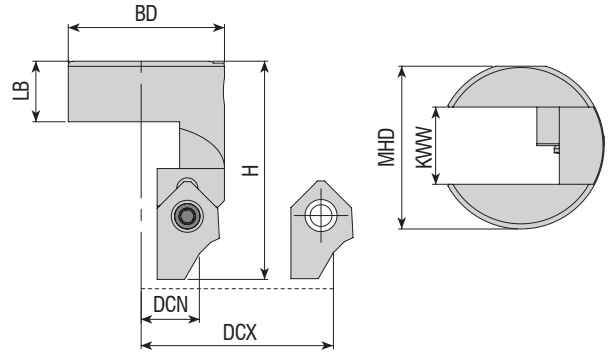

Takım Kodu Ordering Code Bestell-Bezeichnung	Stok Stock Lager	Takım Ölçüleri (mm) Dimension (mm) Abmessung (mm)						Kesici Uç Insert Wendeschneidplatte	Yedek Parçaları / Spare Parts / Ersatzteile			
		DCN DCX	BD	LB	H	KWW	MHD		Sıkma Vidası Screw Schraube	Tork Anahtar Torx Key Torx-Schlüssel	Ayar Vidası Adjustable Einstellschraube	Anahtar Allen Key Innensechskantschlüssel
VST-B11-1830-A	●	18-30	24	9.5	34.0	12	25.3					

R: Sağ / Right / Rechts L: Sol / Left / Links

● Stokta / In Stock / Auf Lager ○ Stokta Yok / Non Stock Item / Kein Lagerartikel, Lieferzeit auf Anfrage

Sipariş Örneği/Ordering Example/Bestellbeispiel

1 ad./pcs./stück VST-B11-2842



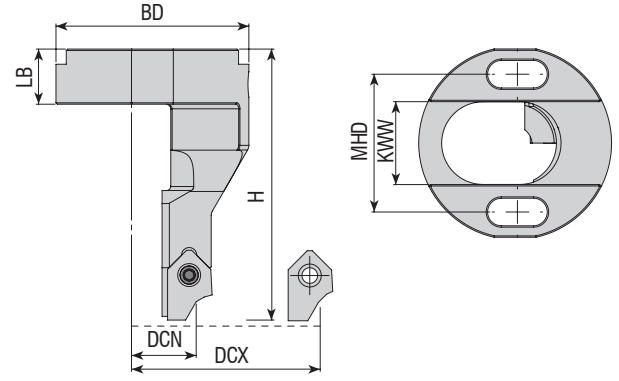

Takım Kodu Ordering Code Bestell-Bezeichnung	Stok Stock Lager	Takım Ölçüleri (mm) Dimension (mm) Abmessung (mm)						Kesici Uç Insert Wendeschneidplatte	Yedek Parçaları / Spare Parts / Ersatzteile				
		DCN DCX	BD	LB	H	KWW	MHD		Sıkma Vidası Screw Schraube	Tork Anahtar Torx Key Torx-Schlüssel	Ayar Vidası Adjustable Einstellschraube	Anahtar Allen Key Innensechskantschlüssel	
VST-B11-2032-A	●	20-32	42	12	59	18	30	B11...					
VST-B11-2434-A	●	24-34	26	14	40	11	18.1						
VST-B11-2956-A	●	26-56	49	11.7	43.7	18	40						

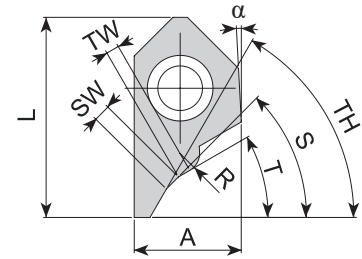
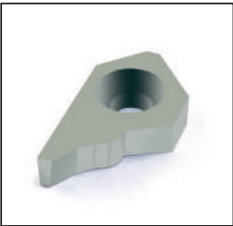

Uç Kodu Insert Code Wendeplatten-Bezeichnung	Stok Stock Lager	Uç Ölçüleri (mm) Insert Dimension (mm) Abmessung (mm)								
		S°	SW	T°	TW	TH°	A	L	α	R
B11013	●	45°	1.3	30°	1	60°	8.15	15.10	3°	1.50

R: Sağ / Right / Rechts L: Sol / Left / Links

● Stokta / In Stock / Auf Lager ○ Stokta Yok / Non Stock Item / Kein Lagerartikel, Lieferzeit auf Anfrage

Sipariş Örneği/Ordering Example/Bestellbeispiel

1 ad./pcs./stück VST-B11-2032



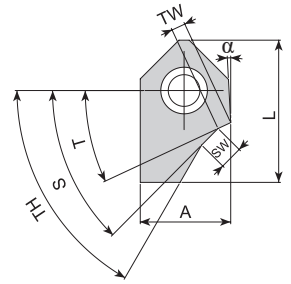

Uç Kodu  
Insert Code  
Wendeplatten-Bezeichnung

Stok  
Stock  
Lager

Uç Ölçüleri (mm)  
Insert Dimension (mm)  
Abmessung (mm)

		S°	SW	T°	TW	TH°	A	L	α
B11003	●	45°	1.3	25°	1.1	52°	9.7	15.25	3°
B11004	●	45°	1.6	25°	1.3	52°	9.7	15.25	3°
B11005	●	45°	2	25°	1.3	52°	9.7	15.25	3°
B11006	●	45°	2.5	25°	1.5	52°	9.7	15.25	3°
B11007	●	45°	1.5	30°	1.5	60°	9.7	15.25	3°
B11008	●	45°	1.3	25°	1.1	60°	9.7	15.25	3°
B11009	●	45°	1.6	25°	1.3	60°	9.7	15.25	3°
B11010	●	45°	2	25°	1.3	60°	9.7	15.25	3°
B11011	●	30°	2	15°	1.8	60°	9.7	15.25	3°
B11012	●	36°	2	15°	1.6	60°	9.7	15.25	3°
B11014	●	45°	2.5	25°	1.5	60°	9.7	15.25	3°
B11016	●	30°	1.5	15°	1.3	60°	9.7	15.25	3°
B11017	●	30°	2.5	15°	1.8	60°	9.7	15.25	3°
B11018	●	36°	2.5	15°	1.6	60°	9.7	15.25	3°
B11019	●	20°	2.5	10°	2	75°	9.7	15.25	3°
B11020	●	45°	1.3	25°	1.1	52°	7.7	15.25	3°
B11021	●	30°	3	15°	1.8	60°	9.7	15.25	3°
B11022	●	45°	3	30°	1.8	60°	9.7	15.25	3°
B11029	●	40°	2.5	25°	1.5	60°	9.7	15.25	3°
B11030	●	20°	2	10°	1.3	60°	9.7	15.25	3°
B11031	●	45°	1.8	30°	1.3	60°	9.7	15.25	3°
B11032	●	45°	1.5	30°	1	52°	9.7	15.25	3°
B11033	●	45°	2	30°	1.1	52°	9.7	15.25	3°
B11034	●	45°	2.5	30°	1.3	52°	9.7	15.25	3°
B11035	●	30°	1.5	15°	1	45°	9.7	15.25	3°
B11036	●	30°	2	15°	1.1	45°	9.7	15.25	3°
B11037	●	30°	2.5	15°	1.3	45°	9.7	15.25	3°
new B11038	●	25°	2	15°	2	45°	9.7	15.25	3°
new B11039	●	30°	2	15°	1.4	60°	9.7	15.25	3°
new B11040	●	40°	2	15°	2	60°	9.7	15.25	3°
new B11042	●	45°	1	30°	1.2	60°	9.7	15.25	3°
new B11043	●	45°	1	35°	1.6	52°	9.7	15.25	3°
new B11044	●	45°	1,3	30°	1	60°	9.7	15.25	3°
new B11045	●	45°	1,5	30°	1	60°	9.7	15.25	3°
new B11046	●	45°	1,8	30°	1	60°	9.7	15.25	3°
new B11047	●	45°	1,8	30°	1,6	60°	9.7	15.25	3°
new B11048	●	45°	1	25°	1,4	60°	9.7	15.25	3°
new B11049	●	45°	1,50	25°	1,4	60°	9.7	15.25	3°
new B11050	●	45°	2	25°	1,4	60°	9.7	15.25	3°
new B11051	●	45°	3	25°	1,4	60°	9.7	15.25	3°
new B11052	●	30°	1,5	15°	1,4	60°	9.7	15.25	3°
new B11053	●	30°	2,5	15°	1,8	60°	9.7	15.25	3°
new B11054	●	45°	1	15°	1	60°	9.7	15.25	3°
new B11055	●	45°	1,5	30°	1,8	60°	9.7	15.25	3°
new B11056	●	45°	2	30°	1,2	60°	9.7	15.25	3°
new B11058	●	35°	2	15°	1,6	60°	9.7	15.25	3°
new B11061	●	45°	1	25°	1,0	60°	9.7	15.25	3°
new B11062	●	30°	1,3	15°	1,0	52°	9.7	15.25	3°
new B11063	●	38°	2,5	15°	1,60	60°	9.7	15.25	3°
new B11064	●	30°	2	15°	1,40	60°	9.7	15.25	3°
new B11065	●	45°	1	25°	0,8	52°	9.7	15.25	3°
new B11066	●	20°	3	10°	2,0	75°	9.7	15.25	3°
new B11069	●	30°	3	15	1,8	45	9.7	15.25	3°

Sipariş Örneği/Ordering Example/Bestellbeispiel  
1 ad./pcs./stück B11003

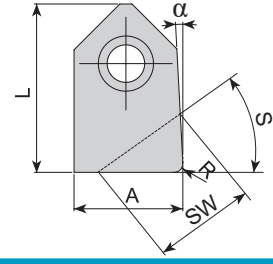

Uç Kodu  
Insert Code  
Wendeplatten-Bezeichnung

Stok  
Stock  
Lager

Uç Ölçüleri (mm)  
Insert Dimension (mm)  
Abmessung (mm)

		S°	SW	A	L	α	R
<b>B11015</b>	●	0°	9.85	9.85	15.10	3°	0.80
<b>B11023</b>	●	0°	7.7	7.7	15.10	3°	0.80
<b>B11024</b>	●	20°	8.2	9.75	15.10	3°	-
<b>B11025</b>	●	25°	10	9.65	15.10	3°	-
<b>B11026</b>	●	30°	9	9.65	15.10	3°	-
<b>B11027</b>	●	35°	10	9.60	15.10	3°	-
<b>B11028</b>	●	45°	8.9	9.55	15.10	3°	-
<b>B11057</b>	●	0	9.6	9.7	14.8	1°	0.2
<b>B11067</b>	●	0	9.9	9.7	15.1	3°	0.2

R: Sağ / Right / Rechts L: Sol / Left / Links

● Stokta / In Stock / Auf Lager ○ Stokta Yok / Non Stock Item / Kein Lagerartikel, Lieferzeit auf Anfrage

Sipariş Örneği/Ordering Example/Bestellbeispiel

1 ad./pcs./stück B11015

### SUBAP UCU BİLGİ ALMA FORMU

INFORMATION REQUEST FORM FOR VALVE SEAT INSERTS  
INFORMATIONSFÖRMULAR FÜR VENTILSITZE

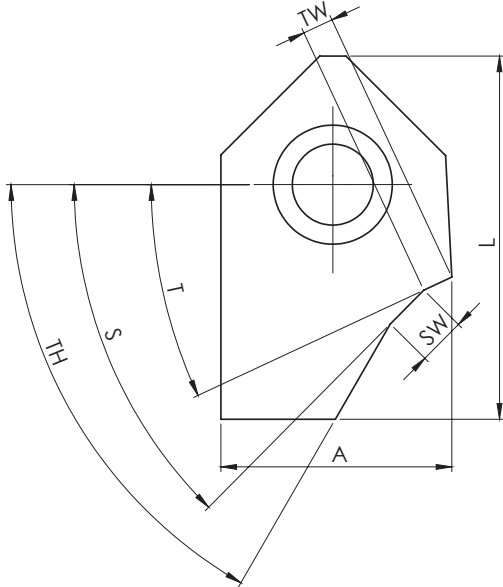

TW :	
L :	
SW :	
A :	
T° :	
S° :	
TH° :	
İLETİŞİM İÇİN: CONTACT: KONTAKT:	

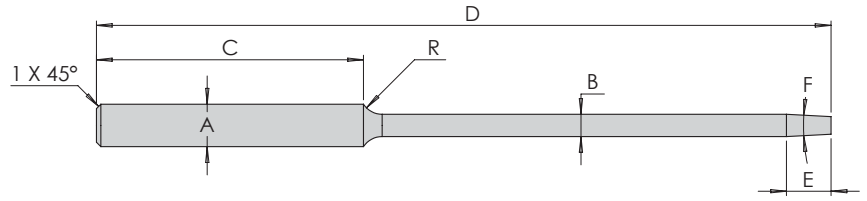

Uç Kodu  
Insert Code

Wendeplatten-Bezeichnung

Stok  
Stock  
Lager

Uç Ölçüleri (mm)  
Insert Dimension (mm)  
Abmessung (mm)

Uç Kodu Insert Code Wendeplatten-Bezeichnung	Stok Stock Lager	Ø B (h7)	C	R	D	Ø A (h6)	E	F
ACPM-0497-165	●	4.97	60	5	165	9.525	10	6°
ACPM-0498-165	●	4.98	60	5	165	9.525	10	6°
ACPM-0499-165	●	4.99	60	5	165	9.525	10	6°
ACPM-0500-165	●	5.00	60	5	165	9.525	10	6°
ACPM-0549-165	●	5.49	60	5	165	9.525	10	6°
ACPM-0550-165	●	5.50	60	5	165	9.525	10	6°
ACPM-0597-165	●	5.97	60	5	165	9.525	10	6°
ACPM-0598-165	●	5.98	60	5	165	9.525	10	6°
ACPM-0599-165	●	5.99	60	5	165	9.525	10	6°
ACPM-0600-165	●	6.00	60	5	165	9.525	10	6°
ACPM-0605-165	●	6.05	60	5	165	9.525	10	6°
ACPM-0606-165	●	6.06	60	5	165	9.525	10	6°
ACPM-0659-165	●	6.59	60	5	165	9.525	10	6°
ACPM-0660-165	●	6.60	60	5	165	9.525	10	6°
ACPM-0697-165	●	6.97	60	5	165	9.525	10	6°
ACPM-0698-165	●	6.98	60	5	165	9.525	10	6°
ACPM-0699-165	●	6.99	60	5	165	9.525	10	6°
ACPM-0700-165	●	7.00	60	5	165	9.525	10	6°
ACPM-0797-165	●	7.97	60	5	165	9.525	10	6°
ACPM-0798-165	●	7.98	60	5	165	9.525	10	6°
ACPM-0799-165	●	7.99	60	5	165	9.525	10	6°
ACPM-0800-165	●	8.00	60	5	165	9.525	10	6°
ACPM-0801-165	●	8.01	60	5	165	9.525	10	6°
ACPM-0802-165	●	8.02	60	5	165	9.525	10	6°
ACPM-0803-165	●	8.03	60	5	165	9.525	10	6°
ACPM-0824-165	●	8.24	60	5	165	9.525	10	6°
ACPM-0825-165	●	8.25	60	5	165	9.525	10	6°
ACPM-0849-165	●	8.49	60	5	165	9.525	10	6°
ACPM-0850-165	●	8.50	60	5	165	9.525	10	6°
ACPM-0897-165	●	8.97	60	5	165	9.525	10	6°
ACPM-0898-165	●	8.98	60	5	165	9.525	10	6°
ACPM-0899-165	●	8.99	60	5	165	9.525	10	6°
ACPM-0900-165	●	9.00	60	5	165	9.525	10	6°

R: Sağ / Right / Rechts L: Sol / Left / Links

● Stokta / In Stock / Auf Lager ○ Stokta Yok / Non Stock Item / Kein Lagerartikel, Lieferzeit auf Anfrage

Sipariş Örneği/Ordering Example/Bestellbeispiel

1 ad./pcs./stück ACPM-0497-165

# U-DRILL

TAKMA UÇLU MATKAPLAR  
U-DRILL SYSTEM  
VOLLBOHRER







**AKKO** **A** **TUM** **16** x **D3**

**S** **P** **G** **T** **06** **02** **04**

**2** Kesici Stili / Cutter Style  
Werkzeugtyp

TUM: Takma Uçlu Matkap  
U-Drill  
Vollbohrer

**3** Takım Çapı / Tool Diameter /  
Werkzeughdurchmesser

**4** Delme Derinliği / Drilling Depth /  
Bohrtiefe

D x 2  
D x 3  
D x 4  
D x 5

**5** Uç Şekli / Insert Form  
Plattenform

**W** **S**

**6** Serbest Uç Açısı / Clearance angle of Insert  
Freiwinkel der Wendeschneidplatte

**C** **P**

**8** Uç Tipi / Insert Type  
Plattentyp

A J T   
 $\beta = 70-90^\circ$   $\beta = 70-90^\circ$   $\beta = 40-60^\circ$

B M U   
 $\beta = 70-90^\circ$   $\beta = 40-60^\circ$   $\beta = 40-60^\circ$

C N W   
 $\beta = 70-90^\circ$   $\beta = 40-60^\circ$   $\beta = 40-60^\circ$

F Q X **Özel**  
 $\beta = 70-90^\circ$   $\beta = 40-60^\circ$  **Special**

G R **Sonder**

H

$\beta = 70-90^\circ$

**10** Kalınlık / Thickness  
Dicke

01 s = 1.59  
T1 s = 1.98  
02 s = 2.38  
T2 s = 2.78  
03 s = 3.18  
T3 s = 3.97  
04 s = 4.76  
05 s = 5.56  
06 s = 6.35  
07 s = 7.94  
09 s = 9.52

**7** Toleranslar / Tolerance Classes / Toleranzen

	IC	M	S
A	± 0.025	± 0.005	± 0.025
C	± 0.025	± 0.013	± 0.025
E	± 0.025	± 0.025	± 0.025
F	± 0.013	± 0.005	± 0.025
G	± 0.025	± 0.025	± 0.130
H	± 0.013	± 0.013	± 0.025
J	± 0.05-0.15	± 0.005	± 0.025
K	± 0.05-0.15	± 0.013	± 0.025
L	± 0.05-0.15	± 0.025	± 0.025
M	± 0.05-0.15	± 0.08-0.20	± 0.130
N	± 0.05-0.15	± 0.08-0.20	± 0.025
U	± 0.08-0.25	± 0.13-0.38	± 0.130

IC : Daire Ölçüsü / Inscribed Circle / Kreisgröße  
M : Şekle Göre / Refer to Figure / Siehe Abbildung  
S : Kalınlık / Thickness / Dicke

**9** Kesme Kenar Uzunluğu / Cutting Edge Length  
Schneidkantenlänge

**11** Köşe Konfigurasyonu / Corner Radius  
Eckenradius

01 r = 0.1  
02 r = 0.2  
04 r = 0.4  
08 r = 0.8  
12 r = 1.2  
16 r = 1.6  
24 r = 2.4

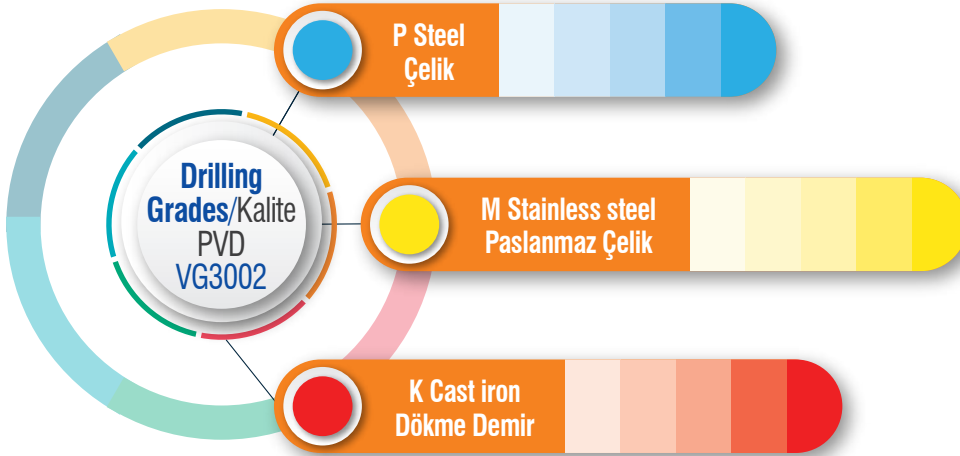

4 Corner / 4 Köşeli  
SPMX Series / Serileri  
00, 01, 02, 03, 04, 05



ISO 3 Corner / 3 Köşeli  
WCMX Series / Serileri  
00, 01, 02, 03, 04, 05

## Grade Information / Kalite Bilgileri

### PVD - TiAIN

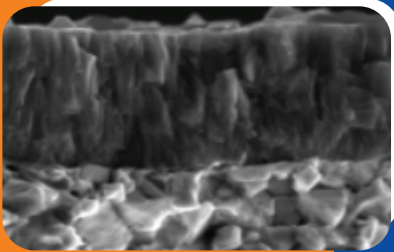

#### Universal grade for General Drilling Application

- Ultra Dense PVD Coating with optimal thermal resistance & strength
- Sub-Micron substrate designed for demanding application

#### Genel Delme Uygulaması için evrensel kalite

- Optimum termal direnç ve güce sahip Ultra Yoğun PVD Kaplama
- Zorlu uygulama için tasarlanmış alt Mikron tabaka

### METRIC

### DRILLING

		Vc (m/min) VG3002	
ISO	SUB GROUP / ALT GRUP	MIN	MAX
P	Non Alloy Steel / Alaşimsız Çelik	180	280
	Low Alloy Steel / Düşük Alaşımlı Çelik	150	250
	High Alloy Steel / Yüksek Alaşımlı Çelik	70	140
M	Ferritic & Martensitic / Ferritik Ve Martenzitik	120	200
	Austenitic Stainless Steel / Östenitik Paslanmaz Çelik	130	250
	Grey Cast Iron / Gri Dökme Demir	120	250
	Nodular Cast Iron / Sferö Döküm Demir	130	220
N	Aluminum / Alüminyum	-	-
S	Titanium & Super Alloy / Titanyum Ve Süper Alaşım	25	45
H	Hardened Material / Sertleştirilmiş Malzeme	-	-



P20 – P35

M20 – M40

K20 – K40

S15 – S25



## Drilling Chipbreakers / Talaş Kırıcı Formlar



-ST



- Sharp Geometry / Keskin Geometri
- Sticky Material, Stainless Steel  
Yapışkan Malzeme, Paslanmaz Çelik

General Inserts  
Genel Uçlar



- First Choice for General Application  
Genel Uygulama İçin İlk Tercih

INCH		DRILLING Vc (m/min) VG3002	
ISO	SUB GROUP / ALT GRUP	MIN	MAX
P	Non Alloy Steel / Alaşimsız Çelik	591	919
	Low Alloy Steel / Düşük Alaşımlı Çelik	492	820
	High Alloy Steel / Yüksek Alaşımlı Çelik	230	459
M	Ferritic & Martensitic / Ferritik Ve Martenzitik	394	656
	Austenitic Stainless Steel / Östenitik Paslanmaz Çelik	427	820
K	Grey Cast Iron / Gri Dökme Demir	394	820
	Nodular Cast Iron / Sferö Döküm Demir	427	711
N	Aluminum / Alüminyum	-	-
S	Titanium & Super Alloy / Titanyum Ve Süper Alaşım	82	148
H	Hardened Material / Sertleştirilmiş Malzeme	-	-

## Drilling Insert / Delik Delme Ucu (SPMX)

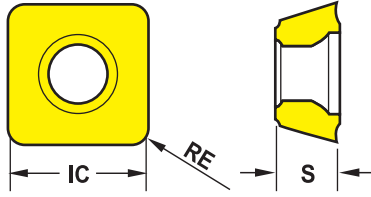

	IC	S
Metric	5	2.38
Inch	0.197	0.094
Metric	6	2.41
Inch	0.236	0.094
Metric	7.94	3.97
Inch	0.313	0.156
Metric	9.8	4.3
Inch	0.386	0.169
Metric	11.5	4.8
Inch	0.453	0.189
Metric	14.3	5.2
Inch	0.563	0.205

ISO 4 Corner  
SPMX Series  
00, 01, 02, 03, 04, 05



EDP	DESCRIPTION	AÇIKLAMA	FEED RATE	İLERLEME
T.01.07.02.00	SPMX050204-VG3002		mm/rev.	0.07~0.14
			Inch/rev.	.003~.006
T.01.07.02.01	SPMX060204-VG3002		mm/rev.	0.08~0.14
			Inch/rev.	.003~.006
T.01.07.02.02	SPMX07T308-VG3002		mm/rev.	0.08~0.16
			Inch/rev.	.003~.006
T.01.07.02.03	SPMX090408-VG3002		mm/rev.	0.08~0.16
			Inch/rev.	.003~.006
T.01.07.02.04	SPMX110408-VG3002		mm/rev.	0.10~0.18
			Inch/rev.	.004~.007
T.01.07.02.05	SPMX140512-VG3002		mm/rev.	0.10~0.20
			Inch/rev.	.004~.008

Cutting Speed / Kesme Hızı			Vc (ft/min)	
ISO	VDI	Sub Group / Alt Grup	VG3002	
			Min	Max
P	1~5	Non-Alloyed Steel / Alaşimsız Çelik	460	1250
	6~9	Low-Alloyed Steel / Düşük Alaşımli Çelik	390	980
	10~11	High-Alloyed Steel / Yüksek Alaşımli Çelik	230	490
M	12~13	Ferritic & Martensitic / Ferritik Ve Martenzitik	390	660
	14	Austenitic Stainless Steel / Östenitik Paslanmaz Çelik	430	820
K	15~16	Grey Cast Iron / Gri Dökme Demir	390	820
	17~18	Nodular Cast Iron / Sferö Döküm Demir	430	720



## Drilling Insert / Delik Delme Ucu (WCMX)

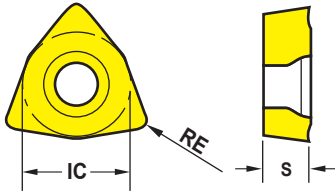

	IC	S
Metric	5.56	2.38
Inch	0.219	0.094
Metric	6.35	2.38
Inch	0.236	0.094
Metric	7.94	3.18
Inch	0.313	0.125
Metric	9.53	3.97
Inch	0.375	0.156
Metric	12.7	4.76
Inch	0.500	0.187



ISO 3 Corner  
WCMX Series  
01, 02, 03, 04, 05



EDP	DESCRIPTION AÇIKLAMA	FEED RATE	İLERLEME
T.01.07.01.01	WCMX030208-VG3002	mm/rev.	0.05~0.12
		Inch/rev.	.002~.005
T.01.07.01.02	WCMX040208-VG3002	mm/rev.	0.05~0.12
		Inch/rev.	.002~.005
T.01.07.01.03	WCMX050308-VG3002	mm/rev.	0.06~0.14
		Inch/rev.	.002~.006
T.01.07.01.04	WCMX06T308-VG3002	mm/rev.	0.08~0.14
		Inch/rev.	.003~.006
T.01.07.01.05	WCMX080412-VG3002	mm/rev.	0.08~0.14
		Inch/rev.	.003~.006

ISO	VDI	Sub Group / Alt Grup	Cutting Speed / Kesme Hızı	
			Vc (ft/min)	
			Min	Max
P	1~5	Non-Alloyed Steel / Alaşimsız Çelik	460	1250
	6~9	Low-Alloyed Steel / Düşük Alaşımli Çelik	390	980
	10~11	High-Alloyed Steel / Yüksek Alaşımli Çelik	230	490
M	12~13	Ferritic & Martensitic / Ferritik Ve Martenzitik	390	660
	14	Austenitic Stainless Steel / Östenitik Paslanmaz Çelik	430	820
K	15~16	Grey Cast Iron / Gri Dökme Demir	390	820
	17~18	Nodular Cast Iron / Sferö Döküm Demir	430	720



Delme Derinliği  
Drilling Depth  
Bohrtiefe

= 2x Çap  
= 2x Diameter  
= 2x Durchmesser

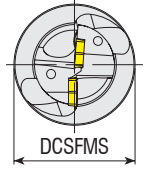
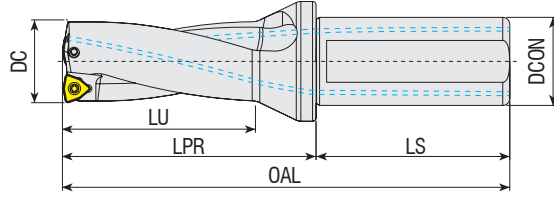

Takım Kodu Ordering Code Bestell-Bezeichnung	Stok Stock Lager	Takım Ölçüleri (mm) Dimension (mm) Abmessung (mm)							Maks. Offset (radyal) Max. Offset (radial) Max. Versatz (radial)		Kesici Uç Insert Wendeschneidplatte	Yedek Parçaları / Spare Parts / Ersatzteile	
		DC	DCON	DCSFMS	OAL	LU	LPR	LS	X <sub>max</sub>	DC <sub>max</sub>		Sıkma Vidası Screw Schraube	Tork Anahtar Torx Key Torx-Schlüssel
ATUM 16XD2 WCM. 030208	●	16	25	34	110	32	54	56	1.5	19	WCM. 030208	3008-M2.5x6	82-T08
ATUM 16.5XD2 WCM. 030208	●	16.5	25	34	110	32	54	56	1.5	19.5			
ATUM 17XD2 WCM. 030208	●	17	25	34	112	34	56	56	1.5	20			
ATUM 17.5XD2 WCM. 030208	●	17.5	25	34	112	34	56	56	1.5	20.5			
ATUM 18XD2 WCM. 030208	●	18	25	34	114	36	58	56	1.4	20.8			
ATUM 18.5XD2 WCM. 030208	●	18.5	25	34	114	36	58	56	1.3	21.1			
ATUM 19XD2 WCM. 030208	●	19	25	34	116	38	60	56	1.2	21.4			
ATUM 19.5XD2 WCM. 030208	●	19.5	25	34	116	38	60	56	1.2	21.9			
ATUM 20XD2 WCM. 040208	●	20	25	34	118	40	62	56	1.5	23			
ATUM 20.5XD2 WCM. 040208	●	20.5	25	34	118	40	62	56	1.5	23.5			
ATUM 21XD2 WCM. 040208	●	21	25	34	120	42	64	56	1	23			
ATUM 21.5XD2 WCM. 040208	●	21.5	25	34	120	42	64	56	1	23.5			
ATUM 22XD2 WCM. 040208	●	22	25	34	122	44	66	56	1	24			
ATUM 22.5XD2 WCM. 040208	●	22.5	25	34	122	44	66	56	1	24.5			
ATUM 23XD2 WCM. 040208	●	23	25	34	124	46	68	56	1	25			
ATUM 23.5XD2 WCM. 040208	●	23.5	25	34	124	46	68	56	1	25.5	WCM. 050308	3008-M3x8	82-T08
ATUM 24XD2 WCM. 050308	●	24	25	34	126	48	70	56	1.4	26.8			
ATUM 24.5XD2 WCM. 050308	●	24.5	25	34	126	48	70	56	1.4	27.3			
ATUM 25XD2 WCM. 050308	●	25	25	34	128	50	72	56	1.45	27.9			
ATUM 25.5XD2 WCM. 050308	●	25.5	25	34	128	50	72	56	1.45	28.4			
ATUM 26XD2 WCM. 050308	●	26	25	34	130	52	74	56	1.45	28.9			
ATUM 26.5XD2 WCM. 050308	●	26.5	25	34	130	52	74	56	1.45	29.4			
ATUM 27XD2 WCM. 050308	●	27	25	34	132	54	76	56	1.45	29.9			
ATUM 27.5XD2 WCM. 050308	●	27.5	25	34	132	54	76	56	1.45	30.4			
ATUM 28XD2 WCM. 050308	●	28	25	34	134	56	78	56	1.6	31.2			
ATUM 28.5XD2 WCM. 050308	●	28.5	25	34	134	56	78	56	1.6	31.7			
ATUM 29XD2 WCM. 050308	●	29	25	34	136	58	80	56	1.65	32.3			
ATUM 29.5XD2 WCM. 050308	●	29.5	25	34	136	58	80	56	1.65	32.8			

R: Sağ / Right / Rechtsl L: Sol / Left / Links

● Stokta / In Stock / Auf Lager ○ Stokta Yok / Non Stock Item / Kein Lagerartikel, Lieferzeit auf Anfrage  
ISO Ucuna Uygun. / Compatible with ISO Insert. / Kompatibel mit ISO Wendeplatten.

Sipariş Örneği/Ordering Example/Bestellbeispiel  
1 ad./pcs./stück ATUM 16XD2 WCM. 030208

Takma Uçlu Matkap Kullanım Kılavuzu : S 375 / User's Guide For U-Drills : P 375  
Bedienungsanleitung für Vollbohrer : S 375



Delme Derinliği  
Drilling Depth  
Bohrtiefe

= 2x Çap  
= 2x Diameter  
= 2x Durchmesser

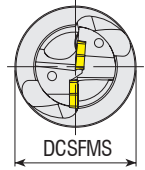
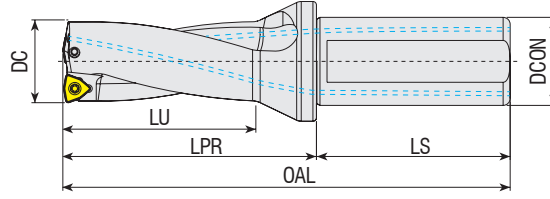

**Takım Kodu**  
**Ordering Code**  
**Bestell-Bezeichnung**

Stok  
Stock  
Lager

Takım Ölçüleri (mm)  
Dimension (mm)  
Abmessung (mm)

Maks. Ofset (radyal)  
Max. Offset (radial)  
Max. Versatz (radial)

Kesici Uç  
Insert  
Wendescheidplatte

Yedek Parçaları / Spare Parts / Ersatzteile

Sıkma Vidası  
Screw  
Schraube

Tork Anahtar  
Torx Key  
Torx-Schlüssel

DC DCON DCSFMS OAL LU LPR LS X<sub>max</sub> DC<sub>max</sub>

Takım Kodu Ordering Code Bestell-Bezeichnung	Stok Stock Lager	DC	DCON	DCSFMS	OAL	LU	LPR	LS	X <sub>max</sub>	DC <sub>max</sub>	Kesici Uç Insert Wendescheidplatte	Sıkma Vidası Screw Schraube	Tork Anahtar Torx Key Torx-Schlüssel
ATUM 30XD2 WCM. 06T308	●	30	32	44	147	60	87	60	2.4	34.8	WCM. 06T308	3010-M3.5x9	82-T10
ATUM 31XD2 WCM. 06T308	●	31	32	44	149	62	89	60	2.3	35.6			
ATUM 32XD2 WCM. 06T308	●	32	32	44	151	64	91	60	2.1	36.2			
ATUM 33XD2 WCM. 06T308	●	33	32	44	153	66	93	60	1.9	36.8			
ATUM 34XD2 WCM. 06T308	●	34	32	44	155	68	95	60	1.9	37.8			
ATUM 35XD2 WCM. 06T308	●	35	32	44	157	70	97	60	1.9	38.8			
ATUM 36XD2 WCM. 06T308	●	36	32	44	159	72	99	60	2	40			
ATUM 37XD2 WCM. 06T308	●	37	32	44	161	74	101	60	1.8	40.6			
ATUM 38XD2 WCM. 06T308	●	38	32	44	163	76	103	60	1.5	41			
ATUM 39XD2 WCM. 06T308	●	39	32	44	165	78	105	60	1.3	41.6			
ATUM 40XD2 WCM. 06T308	●	40	32	44	167	80	107	60	1	42			
ATUM 41XD2 WCM. 06T308	●	41	32	44	169	82	109	60	0.8	42.6			
ATUM 42XD2 WCM. 06T308	●	42	32	44	171	84	111	60	0.5	43			
ATUM 43XD2 WCM. 06T308	●	43	32	44	173	86	113	60	0.3	43.6			
ATUM 44XD2 WCM. 06T308	●	44	32	44	175	88	115	60	0	44			
ATUM 45XD2 WCM. 080412	●	45	40	54	192	90	122	70	3.3	51.6	WCM. 080412	4015-M4x11	80-T15
ATUM 46XD2 WCM. 080412	●	46	40	54	194	92	124	70	3	52			
ATUM 47XD2 WCM. 080412	●	47	40	54	196	94	126	70	2.8	52.6			
ATUM 48XD2 WCM. 080412	●	48	40	54	198	96	128	70	2.5	53			
ATUM 49XD2 WCM. 080412	●	49	40	54	200	98	130	70	2.2	53.4			
ATUM 50XD2 WCM. 080412	●	50	40	54	202	100	132	70	2	54			
ATUM 51XD2 WCM. 080412	●	51	40	54	204	102	134	70	1.8	54.6			
ATUM 52XD2 WCM. 080412	●	52	40	54	206	104	136	70	1.5	55			
ATUM 53XD2 WCM. 080412	●	53	40	54	208	106	138	70	1.3	55.6			
ATUM 54XD2 WCM. 080412	●	54	40	54	210	108	140	70	1	56			
ATUM 55XD2 WCM. 080412	●	55	40	54	212	110	142	70	0.8	56.6			
ATUM 56XD2 WCM. 080412	●	56	40	64	214	112	144	70	0.5	57			
ATUM 57XD2 WCM. 080412	●	57	40	64	216	114	146	70	0.3	57.6			
ATUM 58XD2 WCM. 080412	●	58	40	64	218	116	148	70	0	58			
ATUM 59XD2 WCM. 080412	●	59	40	64	220	118	150	70	0	59			
ATUM 60XD2 WCM. 080412	●	60	40	64	222	120	152	70	0	60			

R: Sağ / Right / Rechts/ L: Sol / Left / Links

● Stokta / In Stock / Auf Lager ○ Stokta Yok / Non Stock Item / Kein Lagerartikel, Lieferzeit auf Anfrage

ISO Ucuna Uygunudur. / Compatible with ISO Insert. / Kompatibel mit ISO Wendeplatten.

Takma Uçlu Matkap Kullanım Kılavuzu : S 375 / User's Guide For U-Drills : P 375 / Bedienungsanleitung für Vollbohrer : S 375

Sipariş Örneği/Ordering Example/Bestellbeispiel

1 ad./pcs./stück ATUM 30XD2 WCM. 06T308



Delme Derinliği  
Drilling Depth  
Bohrtiefe

= 3x Çap  
= 3x Diameter  
= 3x Durchmesser

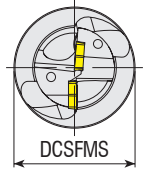
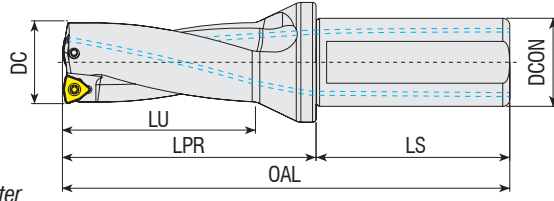

**Takım Kodu**  
**Ordering Code**  
**Bestell-Bezeichnung**

Stok  
Stock  
Lager

Takım Ölçüleri (mm)  
Dimension (mm)  
Abmessung (mm)

Maks. Ofset (radyal)  
Max. Offset (radial)  
Max. Versatz (radial)

Kesici Uç  
Insert  
Wendeschneidplatte

Yedek Parçaları / Spare Parts / Ersatzteile

Sıkma Vidası  
Screw  
Schraube

Tork Anahtar  
Torx Key  
Torx-Schlüssel

Takım Kodu Ordering Code Bestell-Bezeichnung	Stok Stock Lager	DC	DCON	DCSFMS	OAL	LU	LPR	LS	Maks. Ofset (radyal) Max. Offset (radial) Max. Versatz (radial)		Kesici Uç Insert Wendeschneidplatte	Sıkma Vidası Screw Schraube	Tork Anahtar Torx Key Torx-Schlüssel
									X <sub>max</sub>	DC <sub>max</sub>			
ATUM 16XD3 WCM. 030208	●	16	25	34	126	48	70	56	1.5	19	WCM. 030208	3008-M2.5x6	82-T08
ATUM 16.5XD3 WCM. 030208	●	16.5	25	34	126	48	70	56	1.5	19.5			
ATUM 17XD3 WCM. 030208	●	17	25	34	129	51	73	56	1.5	20			
ATUM 17.5XD3 WCM. 030208	●	17.5	25	34	129	51	73	56	1.5	20.5			
ATUM 18XD3 WCM. 030208	●	18	25	34	132	54	76	56	1.4	20.8			
ATUM 18.5XD3 WCM. 030208	●	18.5	25	34	132	54	76	56	1.3	21.1			
ATUM 19XD3 WCM. 030208	●	19	25	34	135	57	79	56	1.2	21.4			
ATUM 19.5XD3 WCM. 030208	●	19.5	25	34	135	57	79	56	1.2	21.9			
ATUM 20XD3 WCM. 040208	●	20	25	34	138	60	82	56	1.5	23	WCM. 040208	3008-M2.5x6	82-T08
ATUM 20.5XD3 WCM. 040208	●	20.5	25	34	138	60	82	56	1.5	23.5			
ATUM 21XD3 WCM. 040208	●	21	25	34	141	63	85	56	1	23			
ATUM 21.5XD3 WCM. 040208	●	21.5	25	34	141	63	85	56	1	23.5			
ATUM 22XD3 WCM. 040208	●	22	25	34	144	66	88	56	1	24			
ATUM 22.5XD3 WCM. 040208	●	22.5	25	34	144	66	88	56	1	24.5			
ATUM 23XD3 WCM. 040208	●	23	25	34	147	69	91	56	1	25			
ATUM 23.5XD3 WCM. 040208	●	23.5	25	34	147	69	91	56	1	25.5			
ATUM 24XD3 WCM. 050308	●	24	25	34	150	72	94	56	1.4	26.8	WCM. 050308	3008-M3x8	82-T08
ATUM 24.5XD3 WCM. 050308	●	24.5	25	34	150	72	94	56	1.4	27.3			
ATUM 25XD3 WCM. 050308	●	25	25	34	153	75	97	56	1.45	27.9			
ATUM 25.5XD3 WCM. 050308	●	25.5	25	34	153	75	97	56	1.45	28.4			
ATUM 26XD3 WCM. 050308	●	26	25	34	156	78	100	56	1.45	28.9			
ATUM 26.5XD3 WCM. 050308	●	26.5	25	34	156	78	100	56	1.45	29.4			
ATUM 27XD3 WCM. 050308	●	27	25	34	159	81	103	56	1.45	29.9			
ATUM 27.5XD3 WCM. 050308	●	27.5	25	34	159	81	103	56	1.45	30.4			
ATUM 28XD3 WCM. 050308	●	28	25	34	162	84	106	56	1.6	31.2			
ATUM 28.5XD3 WCM. 050308	●	28.5	25	34	162	84	106	56	1.6	31.7			
ATUM 29XD3 WCM. 050308	●	29	25	34	165	87	109	56	1.65	32.3			
ATUM 29.5XD3 WCM. 050308	●	29.5	25	34	165	87	109	56	1.65	32.8			
ATUM 30XD3 WCM. 06T308	●	30	32	44	177	90	117	60	2.4	34.8	WCM. 06T308	3010-M3.5x9	82-T10
ATUM 30.5XD3 WCM. 06T308	●	30.5	32	44	177	90	117	60	2.4	35.3			
ATUM 31XD3 WCM. 06T308	●	31	32	44	180	93	120	60	2.3	35.6			
ATUM 31.5XD3 WCM. 06T308	●	31.5	32	44	180	93	120	60	2.3	36.1			
ATUM 32XD3 WCM. 06T308	●	32	32	44	183	96	123	60	2.1	36.2			
ATUM 32.5XD3 WCM. 06T308	●	32.5	32	44	183	96	123	60	2.1	36.7			
ATUM 33XD3 WCM. 06T308	●	33	32	44	186	99	126	60	1.9	36.8			
ATUM 33.5XD3 WCM. 06T308	●	33.5	32	44	186	99	126	60	1.9	37.3			
ATUM 34XD3 WCM. 06T308	●	34	32	44	189	102	129	60	1.9	37.8			
ATUM 34.5XD3 WCM. 06T308	●	34.5	32	44	189	102	129	60	1.9	38.3			

R: Sağ / Right / Rechts/ L: Sol / Left / Links

● Stokta / In Stock / Auf Lager ○ Stokta Yok / Non Stock Item / Kein Lagerartikel, Lieferzeit auf Anfrage  
ISO Uçuna Uygundur. / Compatible with ISO Insert. / Kompatibel mit ISO Wendeplatten.

Sipariş Örneği/Ordering Example/Bestellbeispiel

1 ad./pcs./stück ATUM 16XD3 WCM. 030208

Takma Uçlu Matkap Kullanım Kılavuzu : S 375 / User's Guide For U-Drills : P 375

Bedienungsanleitung für Vollbohrer : S 375





Delme Derinliği  
Drilling Depth  
Bohrtiefe

= 3x Çap  
= 3x Diameter  
= 3x Durchmesser

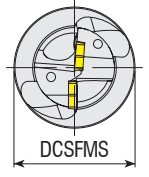
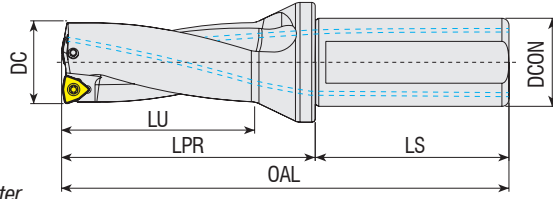

**Takım Kodu**  
**Ordering Code**  
**Bestell-Bezeichnung**

Stok  
Stock  
Lager

Takım Ölçüleri (mm)  
Dimension (mm)  
Abmessung (mm)

Maks. Ofset (radyal)  
Max. Offset (radial)  
Max. Versatz (radial)

Kesici Uç  
Insert  
Wendeschneidplatte

Yedek Parçaları / Spare Parts / Ersatzteile

Sıkma Vidası  
Screw  
Schraube

Tork Anahtar  
Torx Key  
Torx-Schlüssel

DC	DCON	DCSFMS	OAL	LU	LPR	LS	X <sub>max</sub>	DC <sub>max</sub>
							X <sub>max</sub> [mm]	DC <sub>max</sub> [mm]

ATUM 35XD3 WCM. 06T308	●	35	32	44	192	105	132	60	1.9	38.8
ATUM 35.5XD3 WCM. 06T308	●	35.5	32	44	192	105	132	60	1.9	39.3
ATUM 36XD3 WCM. 06T308	●	36	32	44	195	108	135	60	2	40
ATUM 36.5XD3 WCM. 06T308	●	36.5	32	44	195	108	135	60	2	40.5
ATUM 37XD3 WCM. 06T308	●	37	32	44	198	111	138	60	1.8	40.6
ATUM 37.5XD3 WCM. 06T308	●	37.5	32	44	198	111	138	60	1.8	41.1
ATUM 38XD3 WCM. 06T308	●	38	32	44	201	114	141	60	1.5	41
ATUM 38.5XD3 WCM. 06T308	●	38.5	32	44	201	114	141	60	1.5	41.5
ATUM 39XD3 WCM. 06T308	●	39	32	44	204	117	144	60	1.3	41.6
ATUM 39.5XD3 WCM. 06T308	●	39.5	32	44	204	117	144	60	1.3	42.1
ATUM 40XD3 WCM. 06T308	●	40	32	44	207	120	147	60	1	42
ATUM 40.5XD3 WCM. 06T308	●	40.5	32	44	207	120	147	60	1	42.5
ATUM 41XD3 WCM. 06T308	●	41	32	44	210	123	150	60	0.8	42.6
ATUM 41.5XD3 WCM. 06T308	●	41.5	32	44	210	123	150	60	0.8	43.1
ATUM 42XD3 WCM. 06T308	●	42	32	44	213	126	153	60	0.5	43
ATUM 42.5XD3 WCM. 06T308	●	42.5	32	44	213	126	153	60	0.5	43.5
ATUM 43XD3 WCM. 06T308	●	43	32	44	216	129	156	60	0.3	43.6
ATUM 43.5XD3 WCM. 06T308	●	43.5	32	44	216	129	156	60	0.3	44.1
ATUM 44XD3 WCM. 06T308	●	44	32	44	219	132	159	60	0	44
ATUM 44.5XD3 WCM. 06T308	●	44.5	32	44	219	132	159	60	0	44.5
ATUM 45XD3 WCM. 080412	●	45	40	54	237	135	167	70	3.3	51.6
ATUM 45.5XD3 WCM. 080412	●	45.5	40	54	237	135	167	70	3.3	52.1
ATUM 46XD3 WCM. 080412	●	46	40	54	240	138	170	70	3	52
ATUM 47XD3 WCM. 080412	●	47	40	54	243	141	173	70	2.8	52.6
ATUM 48XD3 WCM. 080412	●	48	40	54	246	144	176	70	2.5	53
ATUM 49XD3 WCM. 080412	●	49	40	54	249	147	179	70	2.2	53.4
ATUM 50XD3 WCM. 080412	●	50	40	54	252	150	182	70	2	54
ATUM 51XD3 WCM. 080412	●	51	40	54	255	153	185	70	1.8	54.6
ATUM 52XD3 WCM. 080412	●	52	40	54	258	156	188	70	1.5	55
ATUM 53XD3 WCM. 080412	●	53	40	54	261	159	191	70	1.3	55.6
ATUM 54XD3 WCM. 080412	●	54	40	54	264	162	194	70	1	56
ATUM 55XD3 WCM. 080412	●	55	40	54	267	165	197	70	0.8	56.6
ATUM 56XD3 WCM. 080412	●	56	40	64	270	168	200	70	0.5	57
ATUM 57XD3 WCM. 080412	●	57	40	64	273	171	203	70	0.3	57.6
ATUM 58XD3 WCM. 080412	●	58	40	64	276	174	206	70	0	58
ATUM 59XD3 WCM. 080412	●	59	40	64	279	177	209	70	0	59
ATUM 60XD3 WCM. 080412	●	60	40	64	282	180	212	70	0	60

WCM. 06T308

3010-M3.5x9

82-T10

WCM. 080412

4015-M4x11

80-T15

R: Sağ / Right / Rechts! L: Sol / Left / Links

● Stokta / In Stock / Auf Lager ○ Stokta Yok / Non Stock Item / Kein Lagerartikel, Lieferzeit auf Anfrage  
ISO Ucuna Uygunudur. / Compatible with ISO Insert. / Kompatibel mit ISO Wendeplatten.

Sipariş Örneği/Ordering Example/Bestellbeispiel

1 ad./pcs./stück ATUM 35XD3 WCM. 06T308

Takma Uçlu Matkap Kullanım Kılavuzu : S 375 / User's Guide For U-Drills : P 375

Bedienungsanleitung für Vollbohrer : S 375



Delme Derinliği  
Drilling Depth  
Bohrtiefe  
= 4x Çap  
= 4x Diameter  
= 4x Durchmesser

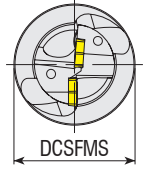
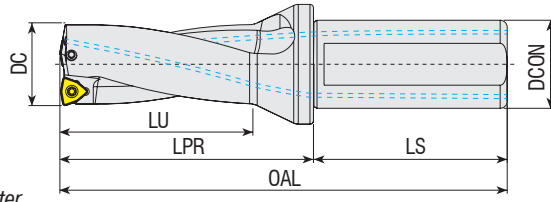

Takım Kodu Ordering Code Bestell-Bezeichnung	Stok Stock Lager	Takım Ölçüleri (mm) Dimension (mm) Abmessung (mm)							Maks. Ofset (radyal) Max. Offset (radial) Max. Versatz (radial)		Kesici Uç Insert Wendescheidplatte	Yedek Parçaları / Spare Parts / Ersatzteile	
		DC	DCON	DCSFMS	OAL	LU	LPR	LS	X <sub>max</sub>	DC <sub>max</sub> [mm]		Sıkma Vidası Screw Schraube	Tork Anahtar Torx Key Torx-Schlüssel
ATUM 16XD4 WCM. 030208	●	16	25	34	142	64	86	56	1.5	19	WCM. 030208	3008-M2.5x6	82-T08
ATUM 16.5XD4 WCM. 030208	○	16.5	25	34	142	64	86	56	1.5	19.5			
ATUM 17XD4 WCM. 030208	●	17	25	34	146	68	90	56	1.5	20			
ATUM 17.5XD4 WCM. 030208	●	17.5	25	34	146	68	90	56	1.5	20.5			
ATUM 18XD4 WCM. 030208	●	18	25	34	150	72	94	56	1.4	20.8			
ATUM 18.5XD4 WCM. 030208	○	18.5	25	34	150	72	94	56	1.3	21.1			
ATUM 19XD4 WCM. 030208	●	19	25	34	154	76	98	56	1.2	21.4			
ATUM 19.5XD4 WCM. 030208	○	19.5	25	34	154	76	98	56	1.2	21.9			
ATUM 20XD4 WCM. 040208	●	20	25	34	158	80	102	56	1.5	23			
ATUM 20.5XD4 WCM. 040208	○	20.5	25	34	158	80	102	56	1.5	23.5			
ATUM 21XD4 WCM. 040208	●	21	25	34	162	84	106	56	1	23			
ATUM 21.5XD4 WCM. 040208	○	21.5	25	34	162	84	106	56	1	23.5			
ATUM 22XD4 WCM. 040208	●	22	25	34	166	88	110	56	1	24			
ATUM 22.5XD4 WCM. 040208	●	22.5	25	34	166	88	110	56	1	24.5			
ATUM 23XD4 WCM. 040208	●	23	25	34	170	92	114	56	1	25			
ATUM 23.5XD4 WCM. 040208	○	23.5	25	34	170	92	114	56	1	25.5	WCM. 050308	3008-M3x8	
ATUM 24XD4 WCM. 050308	●	24	25	34	174	96	118	56	1.4	26.8			
ATUM 24.5XD4 WCM. 050308	○	24.5	25	34	174	96	118	56	1.4	27.3			
ATUM 25XD4 WCM. 050308	●	25	25	34	178	100	122	56	1.45	27.9			
ATUM 25.5XD4 WCM. 050308	○	25.5	25	34	178	100	122	56	1.45	28.4			
ATUM 26XD4 WCM. 050308	●	26	25	34	182	104	126	56	1.45	28.9			
ATUM 26.5XD4 WCM. 050308	●	26.5	25	34	182	104	126	56	1.45	29.4			
ATUM 27XD4 WCM. 050308	●	27	25	34	186	108	130	56	1.45	29.9			
ATUM 27.5XD4 WCM. 050308	○	27.5	25	34	186	108	130	56	1.45	30.4			
ATUM 28XD4 WCM. 050308	●	28	25	34	190	112	134	56	1.6	31.2			
ATUM 28.5XD4 WCM. 050308	●	28.5	25	34	190	112	134	56	1.6	31.7			
ATUM 29XD4 WCM. 050308	●	29	25	34	194	116	138	56	1.65	32.3			
ATUM 29.5XD4 WCM. 050308	○	29.5	25	34	194	116	138	56	1.65	32.8			

R: Sağ / Right / Rechts/ L: Sol / Left / Links

● Stokta / In Stock / Auf Lager ○ Stokta Yok / Non Stock Item / Kein Lagerartikel, Lieferzeit auf Anfrage  
ISO Ucuna Uygun. / Compatible with ISO Insert. / Kompatibel mit ISO Wendeplatten.

Sipariş Örneği/Ordering Example/Bestellbeispiel

1 ad./pcs./stück ATUM 16XD4 WCM. 030208

Takma Uçlu Matkap Kullanım Kılavuzu : S 375 / User's Guide For U-Drills : P 375

Bedienungsanleitung für Vollbohrer : S 375



Delme Derinliği  
Drilling Depth  
Bohrtiefe  
= 4x Çap  
= 4x Diameter  
= 4x Durchmesser

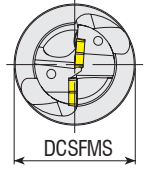
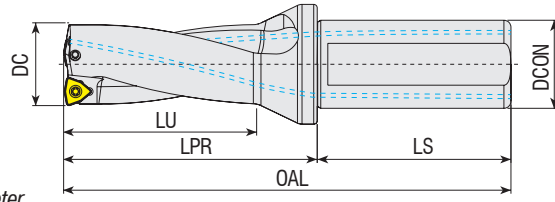

Takım Kodu Ordering Code Bestell-Bezeichnung	Stok Stock Lager	Takım Ölçüleri (mm) Dimension (mm) Abmessung (mm)							Maks. Ofset (radyal) Max. Offset (radial) Max. Versatz (radial)		Kesici Uç Insert Wendeschneidplatte	Yedek Parçaları / Spare Parts / Ersatzteile				
		DC	DCON	DCSFMS	OAL	LU	LPR	LS	X <sub>max</sub>	DC <sub>max</sub>		Sıkma Vidası Screw Schraube	Tork Anahtar Torx Key Torx-Schlüssel			
ATUM 30XD4 WCM. 06T308	●	30	32	44	207	120	147	60	2.4	34.8	WCM. 06T308	3010-M3.5x9	82-T10			
ATUM 31XD4 WCM. 06T308	●	31	32	44	211	124	151	60	2.3	35.6						
ATUM 32XD4 WCM. 06T308	●	32	32	44	215	128	155	60	2.1	36.2						
ATUM 33XD4 WCM. 06T308	●	33	32	44	219	132	159	60	1.9	36.8						
ATUM 33.5XD4 WCM. 06T308	●	33.5	32	44	219	132	159	60	1.9	37.3						
ATUM 34XD4 WCM. 06T308	●	34	32	44	223	136	163	60	1.9	37.8						
ATUM 35XD4 WCM. 06T308	●	35	32	44	227	140	167	60	1.9	38.8						
ATUM 36XD4 WCM. 06T308	●	36	32	44	231	144	171	60	2	40						
ATUM 37XD4 WCM. 06T308	●	37	32	44	235	148	175	60	1.8	40.6						
ATUM 38XD4 WCM. 06T308	●	38	32	44	239	152	179	60	1.5	41						
ATUM 38.5XD4 WCM. 06T308	●	38.5	32	44	239	152	179	60	1.5	41.5						
ATUM 39XD4 WCM. 06T308	●	39	32	44	243	156	183	60	1.3	41.6						
ATUM 40XD4 WCM. 06T308	●	40	32	44	247	160	187	60	1	42						
ATUM 41XD4 WCM. 06T308	●	41	32	44	251	164	191	60	0.8	42.6						
ATUM 42XD4 WCM. 06T308	●	42	32	44	255	168	195	60	0.5	43						
ATUM 43XD4 WCM. 06T308	●	43	32	44	259	172	199	60	0.3	43.6						
ATUM 44XD4 WCM. 06T308	●	44	32	44	263	176	203	60	0	44						
ATUM 45XD4 WCM. 080412	●	45	40	54	282	180	212	70	3.3	51.6				WCM. 080412	4015-M4x11	80-T15
ATUM 46XD4 WCM. 080412	●	46	40	54	286	184	216	70	3	52						
ATUM 47XD4 WCM. 080412	●	47	40	54	290	188	220	70	2.8	52.6						
ATUM 48XD4 WCM. 080412	●	48	40	54	294	192	224	70	2.5	53						
ATUM 49XD4 WCM. 080412	●	49	40	54	298	196	228	70	2.2	53.4						
ATUM 50XD4 WCM. 080412	●	50	40	54	302	200	232	70	2	54						

R: Sağ / Right / Rechts L: Sol / Left / Links  
● Stokta / In Stock / Auf Lager ○ Stokta Yok / Non Stock Item / Kein Lagerartikel, Lieferzeit auf Anfrage  
ISO Ucuna Uygunudur. / Compatible with ISO Insert. / Kompatibel mit ISO Wendeplatten.

Sipariş Örneği/Ordering Example/Bestellbeispiel  
1 ad./pcs./stück ATUM 30XD4 WCM. 06T308  
Takma Uçlu Matkap Kullanım Kılavuzu : S 375 / User's Guide For U-Drills : P 375  
Bedienungsanleitung für Vollbohrer : S 375





Delme Derinliği = 5x Çap  
Drilling Depth = 5x Diameter  
Bohrtiefe = 5x Durchmesser

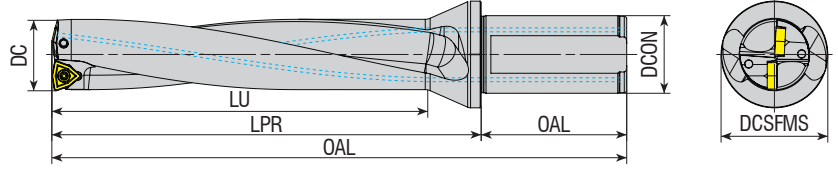

**Takım Kodu**  
**Ordering Code**  
**Bestell-Bezeichnung**

Stok  
Stock  
Lager

Takım Ölçüleri (mm)  
Dimension (mm)  
Abmessung (mm)

Maks. Ofset (radyal)  
Max. Offset (radial)  
Max. Versatz (radial)

Kesici Uç  
Insert  
Wendeschneidplatte

Yedek Parçaları / Spare Parts / Ersatzteile

Sıkma Vidası  
Screw  
Schraube

Tork Anahtar  
Torx Key  
Torx-Schlüssel

Takım Kodu Ordering Code Bestell-Bezeichnung	Stok Stock Lager	DC	DCON	DCSFMS	OAL	LU	LPR	LS	Maks. Ofset (radyal) Max. Offset (radial) Max. Versatz (radial)		Kesici Uç Insert Wendeschneidplatte	Sıkma Vidası Screw Schraube	Tork Anahtar Torx Key Torx-Schlüssel
									X <sub>max</sub> X <sub>max</sub> [mm]	DC <sub>max</sub> DC <sub>max</sub> [mm]			
ATUM 20XD5 WCM. 040208	●	20	25	34	178	100	122	56	1.5	23	WCM. 040208	3008-M2.5x6	
ATUM 21XD5 WCM. 040208	●	21	25	34	183	105	127	56	1	23			
ATUM 22XD5 WCM. 040208	●	22	25	34	188	110	132	56	1	24			
ATUM 23XD5 WCM. 040208	●	23	25	34	193	115	137	56	1	25			
ATUM 24XD5 WCM. 050308	●	24	25	34	198	120	142	56	1.4	26.8	WCM. 050308	3008-M3x8	82-T08
ATUM 25XD5 WCM. 050308	●	25	25	34	203	125	147	56	1.45	27.9			
ATUM 26XD5 WCM. 050308	●	26	25	34	208	130	152	56	1.45	28.9			
ATUM 27XD5 WCM. 050308	●	27	25	34	213	135	157	56	1.45	29.9			
ATUM 28XD5 WCM. 050308	●	28	25	34	218	140	162	56	1.6	31.2			
ATUM 29XD5 WCM. 050308	●	29	25	34	223	145	167	56	1.65	32.3			
ATUM 30XD5 WCM. 06T308	●	30	32	44	237	150	177	60	2.4	34.8	WCM. 06T308	3010-M3.5x9	82-T10
ATUM 31XD5 WCM. 06T308	●	31	32	44	242	155	182	60	2.3	35.6			
ATUM 32XD5 WCM. 06T308	●	32	32	44	247	160	187	60	2.1	36.2			
ATUM 33XD5 WCM. 06T308	●	33	32	44	252	165	192	60	1.9	36.8			
ATUM 34XD5 WCM. 06T308	●	34	32	44	257	170	197	60	1.9	37.8			
ATUM 35XD5 WCM. 06T308	●	35	32	44	262	175	202	60	1.9	38.8			
ATUM 37XD5 WCM. 06T308	●	37	32	44	272	185	212	60	1.8	40.6			
ATUM 38XD5 WCM. 06T308	●	38	32	44	277	190	217	60	1.5	41			
ATUM 46XD5 WCM. 080412	●	46	40	54	332	230	262	70	3	52	WCM. 080412	4015-M4x11	80-T15

R: Sağ / Right / Rechts/ L: Sol / Left / Links

● Stokta / In Stock / Auf Lager ○ Stokta Yok / Non Stock Item / Kein Lagerartikel, Lieferzeit auf Anfrage

ISO Ucuna Uygundur. / Compatible with ISO Insert. / Kompatibel mit ISO Wendeplatten.



www.akkо.com.tr

Sipariş Örneği/Ordering Example/Bestellbeispiel

1 ad./pcs./stück ATUM 20XD5 WCM. 040208

Takma Uçlu Matkap Kullanım Kılavuzu : S 375 / User's Guide For U-Drills : P 375

Bedienungsanleitung für Vollbohrer : S 375





Delme Derinliği  
Drilling Depth  
Bohrtiefe  
= 2x Çap  
= 2x Diameter  
= 2x Durchmesser

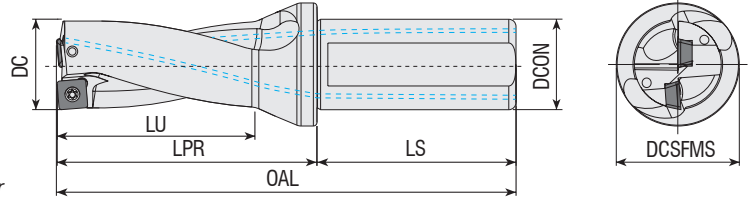

Takım Kodu Ordering Code Bestell-Bezeichnung	Stok Stock Lager	Takım Ölçüleri (mm) Dimension (mm) Abmessung (mm)								Maks. Ofset (radyal) Max. Offset (radial) Max. Versatz (radial)		Kesici Uç Insert Wendescheidplatte	Yedek Parçaları / Spare Parts / Ersatzteile	
		DC	DCON	DCSFMS	OAL	LU	LPR	LS	X <sub>max</sub> X <sub>max</sub> [mm]	DC <sub>max</sub> DC <sub>max</sub> [mm]	Sıkma Vidası Screw Schraube		Tork Anahtar Torx Key Torx-Schlüssel	
ATUM 12.5XD2 SP. 050204	●	12.5	20	25	96	24	46	50	0.75	14	SP. 050204	3006-M2x4	82-T06	
ATUM 13XD2 SP. 050204	●	13	20	25	98	26	48	50	0.75	14.5				
ATUM 13.5XD2 SP. 050204	●	13.5	20	25	98	26	48	50	0.75	15				
ATUM 14XD2 SP. 050204	●	14	20	25	100	28	50	50	0.6	15.2				
ATUM 14.5XD2 SP. 050204	●	14.5	20	25	100	28	50	50	0.6	15.7				
ATUM 15XD2 SP. 050204	●	15	20	25	102	30	52	50	0.5	16				
ATUM 15.5XD2 SP. 060204	●	15.5	20	25	102	30	52	50	0.9	17.3	SP. 060204	3007-M2.2x4.6	82-T07	
ATUM 16XD2 SP. 060204	●	16	25	34	110	32	54	56	0.8	17.6				
ATUM 16.5XD2 SP. 060204	●	16.5	25	34	110	32	54	56	0.8	18.1				
ATUM 17XD2 SP. 060204	●	17	25	34	112	34	56	56	0.75	18.5				
ATUM 17.5XD2 SP. 060204	●	17.5	25	34	112	34	56	56	0.75	19				
ATUM 18XD2 SP. 060204	●	18	25	34	114	36	58	56	0.5	19				
ATUM 18.5XD2 SP. 060204	●	18.5	25	34	114	36	58	56	0.5	19.5				
ATUM 19XD2 SP. 060204	●	19	25	34	116	38	60	56	0.3	19.6				
ATUM 19.5XD2 SP. 060204	●	19.5	25	34	116	38	60	56	0.3	20.1				
ATUM 20XD2 SP. 060204	●	20	25	34	118	40	62	56	0	20				
ATUM 20.5XD2 SP. 060204	●	20.5	25	34	118	40	62	56	0	20.5				
ATUM 21XD2 SP. 060204	●	21	25	34	120	42	64	56	0	21				
ATUM 21.5XD2 SP. 060204	●	21.5	25	34	120	42	64	56	0	21.5				
ATUM 22XD2 SP. 07T308	●	22	25	34	122	44	66	56	1	24	SP. 07T308	3008-M2.5x6	82-T08	
new ATUM 22XD2 SP. 07T308-32	●	22	32	44	131	44	71	60	1	24				
ATUM 22.5XD2 SP. 07T308	●	22.5	25	34	122	44	66	56	1	24.5				
ATUM 23XD2 SP. 07T308	●	23	25	34	124	46	68	56	0.75	24.5				
new ATUM 23XD2 SP. 07T308-32	●	23	32	44	133	46	73	60	0.75	24.5				
ATUM 23.5XD2 SP. 07T308	●	23.5	25	34	124	46	68	56	0.75	25				
ATUM 24XD2 SP. 07T308	●	24	25	34	126	48	70	56	0.5	25				
new ATUM 24XD2 SP. 07T308-32	●	24	32	44	135	48	75	60	0.50	25				
ATUM 24.5XD2 SP. 07T308	●	24.5	25	34	126	48	70	56	0.5	25.5				
ATUM 25XD2 SP. 07T308	●	25	25	34	128	50	72	56	0.25	25.5				
new ATUM 25XD2 SP. 07T308-32	●	25	32	44	137	50	77	60	0.25	25.5				
ATUM 25.5XD2 SP. 07T308	●	25.5	25	34	128	50	72	56	0.25	26				
ATUM 26XD2 SP. 07T308	●	26	25	34	130	52	74	56	0	26				
new ATUM 26XD2 SP. 07T308-32	●	26	32	44	139	52	79	60	0	26				
ATUM 26.5XD2 SP. 07T308	●	26.5	25	34	130	52	74	56	0	26.5				
ATUM 27XD2 SP. 07T308	●	27	25	34	132	54	76	56	0	27				
new ATUM 27XD2 SP. 07T308-32	●	27	32	44	141	54	81	60	0	27				
ATUM 27.5XD2 SP. 07T308	●	27.5	25	34	132	54	76	56	0	27.5				

R: Sağ / Right / Rechts/ L: Sol / Left / Links  
● Stokta / In Stock / Auf Lager ○ Stokta Yok / Non Stock Item / Kein Lagerartikel, Lieferzeit auf Anfrage  
TGTC Ucuna Uygun. / Compatible with TGTC Insert. / Kompatibel mit TGTC Wendeplatten.

Sipariş Örneği/Ordering Example/Bestellbeispiel  
1 ad./pcs./stück ATUM 12.5XD2 SP. 050204  
Takma Uçlu Matkap Kullanım Kılavuzu : S 375 / User's Guide For U-Drills : P 375  
Bedienungsanleitung für Vollbohrer : S 375



Delme Derinliği  
Drilling Depth  
Bohrtiefe

= 2x Çap  
= 2x Diameter  
= 2x Durchmesser

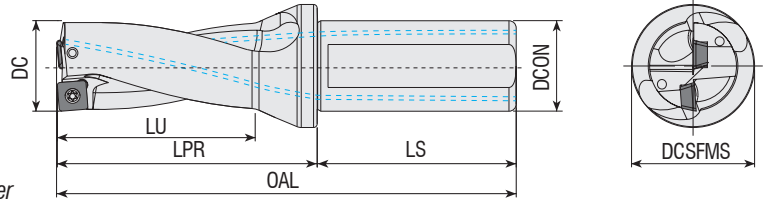

**Takım Kodu**  
**Ordering Code**  
**Bestell-Bezeichnung**

Stok  
Stock  
Lager

Takım Ölçüleri (mm)  
Dimension (mm)  
Abmessung (mm)

Maks. Ofset (radyal)  
Max. Offset (radial)  
Max. Versatz (radial)

Kesici Uç  
Insert  
Wendeschneidplatte

Yedek Parçaları / Spare Parts / Ersatzteile

Sıkma Vidası  
Screw  
Schraube

Tork Anahtar  
Torx Key  
Torx-Schlüssel

DC

DCON

DCSFMS

OAL

LU

LPR

LS

X<sub>max</sub>

X<sub>max</sub>[mm] DC<sub>max</sub>[mm]

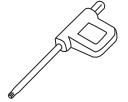

ATUM 28XD2 SP. 090408

●

28

25

34

134

56

78

56

1

30

SP. 090408

4015-M3.5x9

80-T15

new

ATUM 28XD2 SP. 090408-32

●

28

32

44

143

56

83

60

1

29

ATUM 28.5XD2 SP. 090408

●

28.5

25

34

134

56

78

56

1

30.5

ATUM 29XD2 SP. 090408

●

29

25

34

136

58

80

56

0.75

30.5

new

ATUM 29XD2 SP. 090408-32

●

29

32

44

145

58

85

60

0.75

30.5

ATUM 29.5XD2 SP. 090408

●

29.5

25

34

136

58

80

56

0.75

31

ATUM 30XD2 SP. 090408

●

30

32

44

147

60

87

60

0.5

31

ATUM 31XD2 SP. 090408

●

31

32

44

149

62

89

60

0.25

31.5

ATUM 32XD2 SP. 090408

●

32

32

44

151

64

91

60

0

32

ATUM 33XD2 SP. 090408

●

33

32

44

153

66

93

60

0

33

ATUM 34XD2 SP. 110408

●

34

32

44

155

68

95

60

1

36

ATUM 35XD2 SP. 110408

●

35

32

44

157

70

97

60

0.75

36.5

ATUM 36XD2 SP. 110408

●

36

32

44

159

72

99

60

0.6

37.2

ATUM 37XD2 SP. 110408

●

37

32

44

161

74

101

60

0.5

38

ATUM 38XD2 SP. 110408

●

38

32

44

163

76

103

60

0.25

38.5

ATUM 39XD2 SP. 110408

●

39

32

44

165

78

105

60

0

39

ATUM 40XD2 SP. 110408

●

40

32

44

167

80

107

60

0

40

ATUM 41XD2 SP. 110408

●

41

32

44

169

82

109

60

0

41

ATUM 42XD2 SP. 140512

●

42

32

44

171

84

111

60

1.2

44.4

ATUM 43XD2 SP. 140512

●

43

32

44

173

86

113

60

1

45

ATUM 44XD2 SP. 140512

●

44

32

44

175

88

115

60

0.8

45.6

ATUM 45XD2 SP. 140512

●

45

40

54

192

90

122

70

0.6

46.2

ATUM 46XD2 SP. 140512

●

46

40

54

194

92

124

70

0.4

46.8

ATUM 47XD2 SP. 140512

●

47

40

54

196

94

126

70

0.2

47.4

ATUM 48XD2 SP. 140512

●

48

40

54



Delme Derinliği  
Drilling Depth  
Bohrtiefe

= 3x Çap  
= 3x Diameter  
= 3x Durchmesser

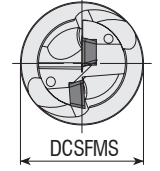
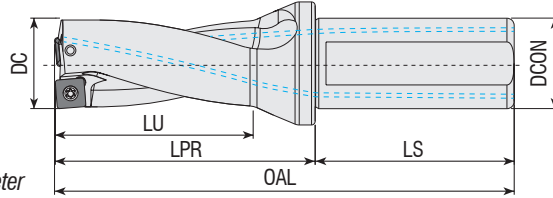

**Takım Kodu**  
**Ordering Code**  
**Bestell-Bezeichnung**

Stok  
Stock  
Lager

Takım Ölçüleri (mm)  
Dimension (mm)  
Abmessung (mm)

Maks. Ofset (radyal)  
Max. Offset (radial)  
Max. Versatz (radial)

Kesici Uç  
Insert  
Wendescheidplatte

Yedek Parçaları / Spare Parts / Ersatzteile

Sıkma Vidası  
Screw  
Schraube

Tork Anahtar  
Torx Key  
Torx-Schlüssel

DC DCON DCSFMS OAL LU LPR LS  
X<sub>max</sub> [mm] DC<sub>max</sub> [mm]



	DC	DCON	DCSFMS	OAL	LU	LPR	LS	X <sub>max</sub> [mm]	DC <sub>max</sub> [mm]				
ATUM 12.5XD3 SP. 050204	●	12.5	20	25	108	36	58	50	0.75	14	SP. 050204	3006-M2x4	82-T06
ATUM 13XD3 SP. 050204	●	13	20	25	111	39	61	50	0.75	14.5			
ATUM 13.5XD3 SP. 050204	●	13.5	20	25	111	39	61	50	0.75	15			
ATUM 14XD3 SP. 050204	●	14	20	25	114	42	64	50	0.6	15.2			
ATUM 14.5XD3 SP. 050204	●	14.5	20	25	114	42	64	50	0.6	15.7			
ATUM 15XD3 SP. 050204	●	15	20	25	117	45	67	50	0.5	16			
ATUM 15.5XD3 SP. 060204	●	15.5	20	25	117	45	67	50	0.9	17.3	SP. 060204	3007-M2.2x4.6	82-T07
ATUM 16XD3 SP. 060204	●	16	25	34	126	48	70	56	0.8	17.6			
ATUM 16.5XD3 SP. 060204	●	16.5	25	34	126	48	70	56	0.8	18.1			
ATUM 17XD3 SP. 060204	●	17	25	34	129	51	73	56	0.75	18.5			
ATUM 17.5XD3 SP. 060204	●	17.5	25	34	129	51	73	56	0.75	19			
ATUM 18XD3 SP. 060204	●	18	25	34	132	54	76	56	0.5	19			
ATUM 18.5XD3 SP. 060204	●	18.5	25	34	132	54	76	56	0.5	19.5			
ATUM 19XD3 SP. 060204	●	19	25	34	135	57	79	56	0.3	19.6			
ATUM 19.5XD3 SP. 060204	●	19.5	25	34	135	57	79	56	0.3	20.1			
ATUM 20XD3 SP. 060204	●	20	25	34	138	60	82	56	0	20			
ATUM 20.5XD3 SP. 060204	●	20.5	25	34	138	60	82	56	0	20.5			
ATUM 21XD3 SP. 060204	●	21	25	34	141	63	85	56	0	21			
ATUM 21.5XD3 SP. 060204	●	21.5	25	34	141	63	85	56	0	21.5			
ATUM 22XD3 SP. 07T308	●	22	25	34	144	66	88	56	1	24	SP. 07T308	3008-M2.5x6	82-T08
new ATUM 22XD3 SP. 07T308-32	●	22	32	44	153	66	93	60	1	23			
ATUM 22.5XD3 SP. 07T308	●	22.5	25	34	144	66	88	56	1	24.5			
ATUM 23XD3 SP. 07T308	●	23	25	34	147	69	91	56	0.75	24.5			
new ATUM 23XD3 SP. 07T308-32	●	23	32	44	156	69	96	60	0.75	24.5			
ATUM 23.5XD3 SP. 07T308	●	23.5	25	34	147	69	91	56	0.75	25			
ATUM 24XD3 SP. 07T308	●	24	25	34	150	72	94	56	0.5	25			
new ATUM 24XD3 SP. 07T308-32	●	24	32	44	159	72	99	60	0.50	25			
ATUM 24.5XD3 SP. 07T308	●	24.5	25	34	150	72	94	56	0.5	25.5			
ATUM 25XD3 SP. 07T308	●	25	25	34	153	75	97	56	0.25	25.5			
new ATUM 25XD3 SP. 07T308-32	●	25	32	44	162	75	102	60	0.25	25.5			
ATUM 25.5XD3 SP. 07T308	●	25.5	25	34	153	75	97	56	0.25	26			
new ATUM 26XD3 SP. 07T308	●	26	25	34	156	78	100	56	0	26			
new ATUM 26XD3 SP. 07T308-32	●	26	32	44	165	78	105	60	0	26			
ATUM 26.5XD3 SP. 07T308	●	26.5	25	34	156	78	100	56	0	26.5			
ATUM 27XD3 SP. 07T308	●	27	25	34	159	81	103	56	0	27			
new ATUM 27XD3 SP. 07T308-32	●	27	32	44	168	81	108	60	0	27			
ATUM 27.5XD3 SP. 07T308	●	27.5	25	34	159	81	103	56	0	27.5			
ATUM 28XD3 SP. 090408	●	28	25	34	162	84	106	56	1	30	SP. 090408	4015-M3.5x9	80-T15
new ATUM 28XD3 SP. 090408-32	●	28	32	44	171	84	111	60	1	29			
ATUM 28.5XD3 SP. 090408	●	28.5	25	34	162	84	106	56	1	30.5			
ATUM 29XD3 SP. 090408	●	29	25	34	165	87	109	56	0.75	30.5			
new ATUM 29XD3 SP. 090408-32	●	29	32	44	174	87	114	6	0.75	30.5			
ATUM 29.5XD3 SP. 090408	●	29.5	25	34	165	87	109	56	0.75	31			
ATUM 30XD3 SP. 090408	●	30	32	44	177	90	117	60	0.5	31			
ATUM 30.5XD3 SP. 090408	●	30.5	32	44	177	90	117	60	0.5	31.5			
ATUM 31XD3 SP. 090408	●	31	32	44	180	93	120	60	0.25	31.5			
ATUM 31.5XD3 SP. 090408	●	31.5	32	44	180	93	120	60	0.25	32			
ATUM 32XD3 SP. 090408	●	32	32	44	183	96	123	60	0	32			
ATUM 32.5XD3 SP. 090408	●	32.5	32	44	183	96	123	60	0	32.5			
ATUM 33XD3 SP. 090408	●	33	32	44	186	99	126	60	0	33			
ATUM 33.5XD3 SP. 090408	●	33.5	32	44	186	99	126	60	0	33.5			

R: Sağ / Right / Rechts L: Sol / Left / Links

● Stokta / In Stock / Auf Lager ○ Stokta Yok / Non Stock Item / Kein Lagerartikel, Lieferzeit auf Anfrage

TGTC Ucuna Uygun. / Compatible with TGTC Insert. / Kompatibel mit TGTC Wendeplatten.

Sipariş Örneği/Ordering Example/Bestellbeispiel

1 ad./pcs./stück ATUM 12.5XD3 SP. 050204

Takma Uçlu Matkap Kullanım Kılavuzu : S 375 / User's Guide For U-Drills : P 375

Bedienungsanleitung für Vollbohrer : S 375



Delme Derinliği = 3x Çap  
Drilling Depth = 3x Diameter  
Bohrtiefe = 3x Durchmesser

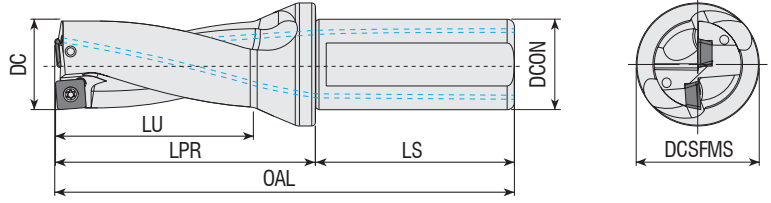

Takım Kodu  
Ordering Code  
Bestell-Bezeichnung

Stok  
Stock  
Lager

Takım Ölçüleri (mm)  
Dimension (mm)  
Abmessung (mm)

Maks. Ofset (radyal)  
Max. Offset (radial)  
Max. Versatz (radial)

Kesici Uç  
Insert  
Wendeschneidplatte

Yedek Parçaları / Spare Parts / Ersatzteile

Sıkma Vidası  
Screw  
Schraube

Tork Anahtar  
Torx Key  
Torx-Schlüssel

Takım Kodu Ordering Code Bestell-Bezeichnung	Stok Stock Lager	Takım Ölçüleri (mm) Dimension (mm) Abmessung (mm)							Maks. Ofset (radyal) Max. Offset (radial) Max. Versatz (radial)		Kesici Uç Insert Wendeschneidplatte	Sıkma Vidası Screw Schraube	Tork Anahtar Torx Key Torx-Schlüssel
		DC	DCON	DCSFMS	OAL	LU	LPR	LS	X <sub>max</sub>	DC <sub>max</sub>			
ATUM 34XD3 SP. 110408	●	34	32	44	189	102	129	60	1	36	SP. 110408	4015-M4x11	80-T15
ATUM 34.5XD3 SP. 110408	●	34.5	32	44	189	102	129	60	1	36.5			
ATUM 35XD3 SP. 110408	●	35	32	44	192	105	132	60	0.75	36.5			
ATUM 35.5XD3 SP. 110408	●	35.5	32	44	192	105	132	60	0.75	37			
ATUM 36XD3 SP. 110408	●	36	32	44	195	108	135	60	0.6	37.2			
ATUM 36.5XD3 SP. 110408	●	36.5	32	44	195	108	135	60	0.6	37.7			
ATUM 37XD3 SP. 110408	●	37	32	44	198	111	138	60	0.5	38			
ATUM 37.5XD3 SP. 110408	●	37.5	32	44	198	111	138	60	0.5	38.5			
ATUM 38XD3 SP. 110408	●	38	32	44	201	114	141	60	0.25	38.5			
ATUM 38.5XD3 SP. 110408	●	38.5	32	44	201	114	141	60	0.25	39			
ATUM 39XD3 SP. 110408	●	39	32	44	204	117	144	60	0	39			
ATUM 39.5XD3 SP. 110408	●	39.5	32	44	204	117	144	60	0	39.5			
ATUM 40XD3 SP. 110408	●	40	32	44	207	120	147	60	0	40			
ATUM 40.5XD3 SP. 110408	●	40.5	32	44	207	120	147	60	0	40.5			
ATUM 41XD3 SP. 110408	●	41	32	44	210	123	150	60	0	41			
ATUM 41.5XD3 SP. 110408	●	41.5	32	44	210	123	150	60	0	41.5			
ATUM 42XD3 SP. 140512	●	42	32	44	213	126	153	60	1.2	44.4	SP. 140512	1020-M5x11	80-T20
ATUM 42.5XD3 SP. 140512	●	42.5	32	44	213	126	153	60	1.2	44.9			
ATUM 43XD3 SP. 140512	●	43	32	44	216	129	156	60	1	45			
ATUM 43.5XD3 SP. 140512	●	43.5	32	44	216	129	156	60	1	45.5			
ATUM 44XD3 SP. 140512	●	44	32	44	219	132	159	60	0.8	45.6			
ATUM 44.5XD3 SP. 140512	●	44.5	32	44	219	132	159	60	0.8	46.1			
ATUM 45XD3 SP. 140512	●	45	40	54	237	135	167	70	0.6	46.2			
ATUM 45.5XD3 SP. 140512	●	45.5	40	54	237	135	167	70	0.6	46.7			
ATUM 46XD3 SP. 140512	●	46	40	54	240	138	170	70	0.4	46.8			
ATUM 47XD3 SP. 140512	●	47	40	54	243	141	173	70	0.2	47.4			
ATUM 48XD3 SP. 140512	●	48	40	54	246	144	176	70	0	48			
ATUM 49XD3 SP. 140512	●	49	40	54	249	147	179	70	0	49			
ATUM 50XD3 SP. 140512	●	50	40	54	252	150	182	70	0	50			
ATUM 51XD3 SP. 140512	●	51	40	54	255	153	185	70	0	51			
ATUM 52XD3 SP. 140512	●	52	40	54	258	156	188	70	0	52			

R: Sağ / Right / Rechts/ L: Sol / Left / Links

● Stokta / In Stock / Auf Lager ○ Stokta Yok / Non Stock Item / Kein Lagerartikel, Lieferzeit auf Anfrage  
TGTC Ucuna Uygunudur. / Compatible with TGTC Insert. / Kompatibel mit TGTC Wendeplatten.

Sipariş Örneği/Ordering Example/Bestellbeispiel

1 ad./pcs./stück ATUM 34XD3 SP. 110408

Takma Uçlu Matkap Kullanım Kılavuzu : S 375 / User's Guide For U-Drills : P 375

Bedienungsanleitung für Vollbohrer : S 375





Delme Derinliği  
Drilling Depth  
Bohrtiefe

= 4x Çap  
= 4x Diameter  
= 4x Durchmesser

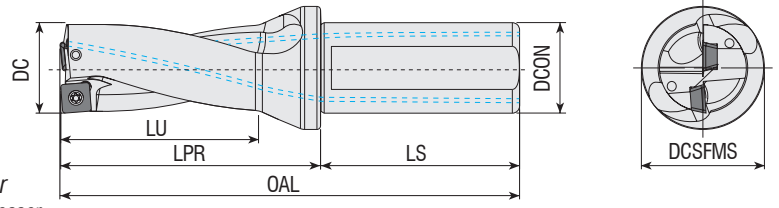

Takım Kodu  
Ordering Code  
Bestell-Bezeichnung

Stok  
Stock  
Lager

Takım Ölçüleri (mm)  
Dimension (mm)  
Abmessung (mm)

Maks. Ofset (radyal)  
Max. Offset (radial)  
Max. Versatz (radial)

Kesici Uç  
Insert  
Wendescheidplatte

Yedek Parçaları / Spare Parts / Ersatzteile

Sıkma Vidası  
Screw  
Schraube

Tork Anahtar  
Torx Key  
Torx-Schlüssel



ATUM	Takım Kodu	SP.	Stok	DC	DCON	DCSFMS	OAL	LU	LPR	LS	Maks. Ofset	Kesici Uç	Sıkma Vidası	Tork Anahtar			
															Ordering Code	Stock	Dimension (mm)
	Bestell-Bezeichnung		Lager														
	13XD4	SP. 050204	●	13	20	25	124	52	74	50	0.75	SP. 050204	3006-M2x4	82-T06			
	14XD4	SP. 050204	●	14	20	25	128	56	78	50	0.6				3006-M2.5x4		
new	14.5XD4	SP. 050204	●	14.5	20	25	128	56	78	50	0.60						
	15XD4	SP. 050204	●	15	20	25	132	60	82	50	0.5	SP. 060204	3007-M2.2x4.6	82-T07			
	16XD4	SP. 060204	●	16	25	34	142	64	86	56	0.8						
	17XD4	SP. 060204	●	17	25	34	146	68	90	56	0.75						
	17.5XD4	SP. 060204	●	17.5	25	34	146	68	90	56	0.75						
	18XD4	SP. 060204	●	18	25	34	150	72	94	56	0.5						
	19XD4	SP. 060204	●	19	25	34	154	76	98	56	0.3						
	19.5XD4	SP. 060204	●	19.5	25	34	154	76	98	56	0.3						
	20XD4	SP. 060204	●	20	25	34	158	80	102	56	0						
	21XD4	SP. 060204	●	21	25	34	162	84	106	56	0						
	22XD4	SP. 07T308	●	22	25	34	166	88	110	56	1				SP. 07T308	3008-M2.5x6	82-T08
	23XD4	SP. 07T308	●	23	25	34	170	92	114	56	0.75						
	23.5XD4	SP. 07T308	●	23.5	25	34	170	92	114	56	0.75						
	24XD4	SP. 07T308	●	24	25	34	174	96	118	56	0.5						
	25XD4	SP. 07T308	●	25	25	34	178	100	122	56	0.25						
	26XD4	SP. 07T308	●	26	25	34	182	104	126	56	0						
	27XD4	SP. 07T308	●	27	25	34	186	108	130	56	0						
	27.5XD4	SP. 07T308	●	27.5	25	34	186	108	130	56	0						
	28XD4	SP. 090408	●	28	25	34	190	112	134	56	1	SP. 090408	4015-M3.5x9	80-T15			
	29XD4	SP. 090408	●	29	25	34	194	116	138	56	0.75						
	30XD4	SP. 090408	●	30	32	44	207	120	147	60	0.5						
	31XD4	SP. 090408	●	31	32	44	211	124	151	60	0.25						
	32XD4	SP. 090408	●	32	32	44	215	128	155	60	0						
	33XD4	SP. 090408	●	33	32	44	219	132	159	60	0						
	33.5XD4	SP. 090408	●	33.5	32	44	219	132	159	60	0						
	34XD4	SP. 110408	●	34	32	44	223	136	163	60	1				SP. 110408	4015-M4x11	80-T15
	35XD4	SP. 110408	●	35	32	44	227	140	167	60	0.75						
	36XD4	SP. 110408	●	36	32	44	231	144	171	60	0.6						
	37XD4	SP. 110408	●	37	32	44	235	148	175	60	0.5						
	38XD4	SP. 110408	●	38	32	44	239	152	179	60	0.25						
	39XD4	SP. 110408	●	39	32	44	243	156	183	60	0						
	40XD4	SP. 110408	●	40	32	44	247	160	187	60	0						
	41XD4	SP. 110408	●	41	32	44	251	164	191	60	0						
	42XD4	SP. 140512	●	42	32	44	255	168	195	60	1.2	SP. 140512	1020-M5x11	80-T20			
	43XD4	SP. 140512	●	43	32	44	259	172	199	60	1						
	44XD4	SP. 140512	●	44	32	44	263	176	203	60	0.8						
new	46XD4	SP. 140512	●	46	40	54	286	184	216	70	0.40						

R: Sağ / Right / Rechts/ L: Sol / Left / Links

● Stokta / In Stock / Auf Lager ○ Stokta Yok / Non Stock Item / Kein Lagerartikel, Lieferzeit auf Anfrage  
TGTC Ucuna Uygunudur. / Compatible with TGTC Insert. / Kompatibel mit TGTC Wendeplatten.

Sipariş Örneği/Ordering Example/Bestellbeispiel/

1 ad./pcs./stück ATUM 13XD4 SP. 050204

Takma Uçlu Matkap Kullanım Kılavuzu : S 375 / User's Guide For U-Drills : P 375

Bedienungsanleitung für Vollbohrer : S 375

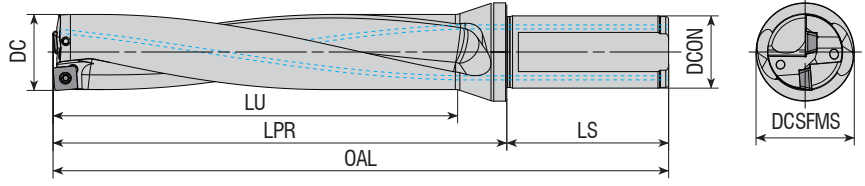

Delme Derinliği = 5x Çap  
Drilling Depth = 5x Diameter  
Bohrtiefe = 5x Durchmesser

**Takım Kodu**  
**Ordering Code**  
**Bestell-Bezeichnung**

Stok  
Stock  
Lager

Takım Ölçüleri (mm)  
Dimension (mm)  
Abmessung (mm)

Maks. Ofset (radyal)  
Max. Offset (radial)  
Max. Versatz (radial)

Kesici Uç  
Insert  
Wendescheidplatte

Yedek Parçaları / Spare Parts / Ersatzteile

Sıkma Vidası  
Screw  
Schraube

Tork Anahtar  
Torx Key  
Torx-Schlüssel

new

ATUM 13XD5 SP. 050204

●

13

20

25

137

65

87

50

0.75

14.5

SP. 050204

3006-M2.5x4

3006-M2x4

82-T06

new

ATUM 14.5XD5 SP. 050204

●

14.5

20

25

142

70

92

50

0.60

15.7

3006-M2.5x4

new

ATUM 15XD5 SP. 050204

●

15

20

25

147

75

97

50

0.50

16

new

ATUM 17XD5 SP. 060204-32

●

17

32

34

163

85

107

56

0.75

18.5

SP. 060204

3007-M2.2x4.6

3007-M2.2x5

82-T07

ATUM 16XD5 SP. 060204

●

16

25

34

158

80

102

56

0.8

17.6

ATUM 17XD5 SP. 060204

●

17

25

34

163

85

107

56

0.75

18.5

ATUM 18XD5 SP. 060204

●

18

25

34

168

90

112

56

0.5

19

ATUM 19XD5 SP. 060204

●

19

25

34

173

95

117

56

0.3

19.6

ATUM 20XD5 SP. 060204

●

20

25

34

178

100

122

56

0

20

ATUM 21XD5 SP. 060204

●

21

25

34

183

105

127

56

0

21

ATUM 22XD5 SP. 07T308

●

22

25

34

188

110

132

56

1

24

ATUM 22XD5 SP. 07T308-32

●

22

32

44

197

110

137

60

1

24

ATUM 23XD5 SP. 07T308

●

23

25

34

193

115

137

56

0.75

24.5

ATUM 23XD5 SP. 07T308-32

●

23

32

44

202

115

142

60

0.75

24.5

ATUM 24XD5 SP. 07T308-32

●

24

32

44

207

120

147

60

0.5

25

ATUM 25XD5 SP. 07T308

●

25

25

34

203

125

147

56

0.25

25.5

ATUM 25XD5 SP. 07T308-32

●

25

32

44

212

125

152

60

0.25

25.5

ATUM 26XD5 SP. 07T308

●

26

25

34

208

130

152

56

0

26

ATUM 26XD5 SP. 07T308-32

●

26

32

44

217

130

157

60

0

26

ATUM 27XD5 SP. 07T308

●

27

25

34

213

135

157

56

0

27

ATUM 27XD5 SP. 07T308-32

●

27

32

44

222

135

162

60

0

27

ATUM 28XD5 SP. 090408-32

●

28

32

44

227

140

167

60

1

30

ATUM 29XD5 SP. 090408-32

●

29

32

44

232

145

172

60

0.75

30.5

ATUM 30XD5 SP. 090408

●

30

32

44

237

150

177

60

0.5

31

ATUM 31XD5 SP. 090408

●

31

32

44

242

155

182

60

# HELİSEL İÇTEN SU VERME KANALLI MATKAPLAR

## INDEXABLE DRILLS WITH HELICAL COOLANT HOLE

### INDIZIERBARE VOLLBOHRER MIT HELIX KÜHLUNGSHÖHLEN

Farklı çaplarda ve ALFA KAPLAMA teknolojisi ile siparişe hazır.

*They are ready to order in different diameters and with ALPHA COATING technology.*

*Die Vollbohrer sind in unterschiedlichen Dimensionen und mit ALFABESCHICHTUNGSTECHNOLOGY bereit für die Bestellungen.*

- Helisel içten su verme kanallı
- Üstün Alpha Kaplama Teknolojisi
- 1000 Vickers'e dayanan yüksek yüzey sertliği
- Aşınmaya karşı yüksek direnç
- Dengeli ve hassas kesim
- Helical Internal Coolant Holes
- Superior Alpha Coating Technology
- High surface hardness up to 1000 Vickers
- High resistance to abrasion
- Balanced and precise cutting
- Helix innterne Kühlungshöhlen
- Überragende Alphabeschichtungsstechnologie
- Hohe Oberflächen Härte bis zu 1000 Vickers.
- Hoher Widerstand gegen Abnutzung
- Ausgewogene und präzise Bearbeitung

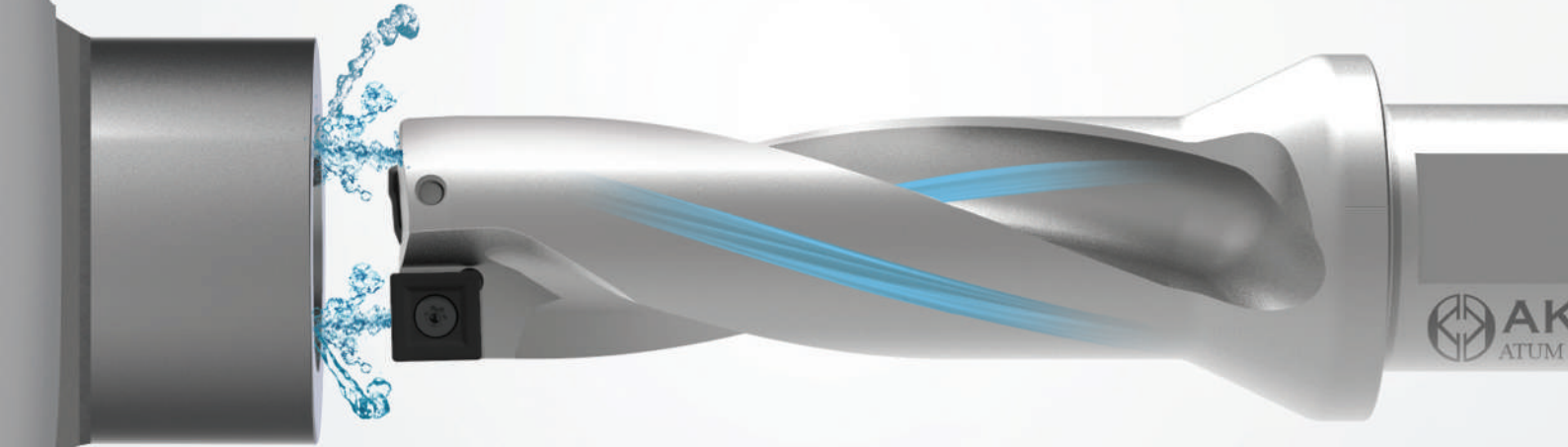

AKKO HELİSEL KANAL TEKNOLOJİSİ  
**AKKO HELICAL CHANNEL TECHNOLOGY**  
AKKO HELIX KANAL TECHNOLOGIE

RAKİPLER  
**COMPETITORS**  
KONKURRENZ

\* STOK DURUMU / STOCK STATUS / STOCK STATUS

**D2 / D3 / D4 / D5**

\* Helisel İçten Su Verme Kanallı  
**Twisted Coolant Hole**  
Spiralförmige Kühlungshöhlen

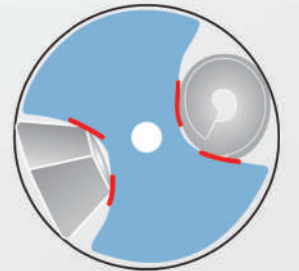



# KESME & KANAL AÇMA UÇ VE TAKIMLARI

GROOVING & PARTING INSERT AND TOOLS  
EINSTECH- UND ABSTECHWENDESCHNEIDPLATTEN  
UND WERKZEUGE

AGD-MT / AGD-MR Uç Serisi / Insert Series / Insert Serie





## Kesme ve Kanal Açma Uçlarına Genel Bakış

### Overview of Parting and Grooving Inserts

Überblick über Wendeschneidplatten zum Abstechen und Einstechen

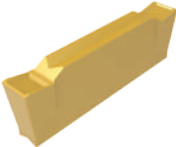
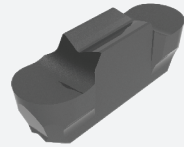
Form Shape	Geometri Geometry	Ugulama Application	Genişlik Width
	AGD-MT	Medium Turning	2.0-8.0 (mm)
	AGD-MR	Medium Profiling	2.0-8.0 (mm)

## Önerilen Kesme Değerleri

### Recommended Cutting Datas

Empfohlene Schnittdaten

#### AGD-MT

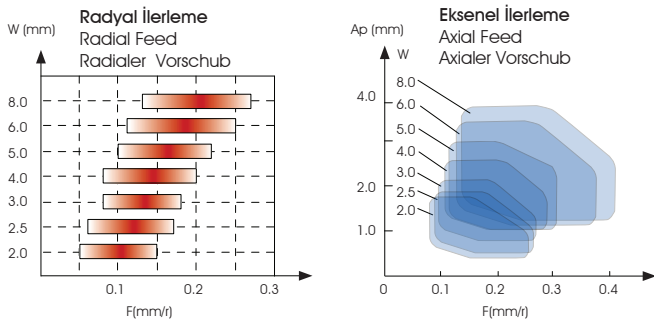

#### AGD-MR

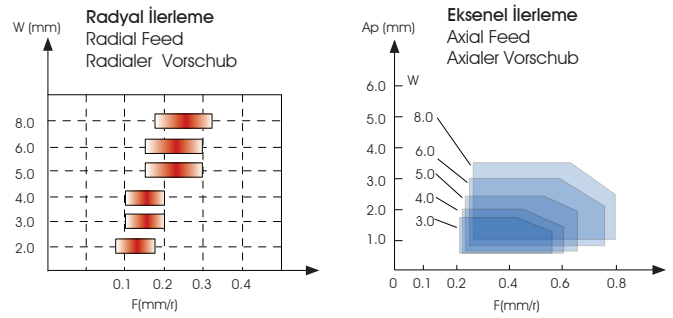

ISO	İs Parçası Malzemesi Workpiece Material	Sertlik Hardness (HB)	Kesme Hızı / Cutting Speed Vc m/min / Schneidgeschwindigkeit						
			AP1105	AP1225	AK1115	AS3115	AS3125	AA4230	AS9125
P	Düşük Karbonlu Çelik Low Carbon Steel	80 – 170	120 (80-220)	120 (80-220)		70 (50-100)	70 (50-100)	110 (70-180)	
	Yüksek Karbonlu Çelik High Carbon Steel	170 – 250	120 (80-220)	120 (80-220)				110 (70-150)	
	Düşük Alaşımli Çelik Low-alloy Steel	140– 260	110 (60-180)	110 (60-180)		70 (50-100)	70 (50-100)	(40-150)	
	Yüksek Alaşımli Çelik High-alloy Steel	180– 300	110 (60-180)	110 (60-180)				110 (40-150)	
	Dökme Çelik Cast Steel	180– 300	110 (60-180)	110 (60-180)				110 (40-150)	
M	Feritik / Martenzitik Ferritic/ Martensitic	150– 270				90 (50-150)	90 (30-180)	110 (40-180)	
	Östenitik Austenitic	150– 270				90 (50-150)	90 (30-180)	(40-180)	
K	Dövülebilir Dökme Demir Malleable Cast Iron	150– 230			130 (50-200)			(50-180)	
	Grİ Dökme Demir Gray Cast Iron	150– 230			130 (50-200)			110 (50-180)	
	Sferö Döküm Demir Nodular Cast Iron	160– 260			100 (50-150)			100 (50-150)	
S	Isıya Dayanıklı Alaşımlar Heat-resistant Alloy	130– 400				35 (15-60)	35 (15-70)		
	Titanyum Alaşımlar Titanium Alloys	130– 400				35 (15-60)	35 (15-70)		35 (15-60)

1	2	3	4-5	6-7	8	9	10
A	G	D	30--04	MT	A	A	4230
AKKO	GROOVING KANAL AÇMA	D DOUBLE SIDE ÇİFT TARAFLI S SINGLE SIDE TEK TARAFLI	WIDTH GENİŞLİK CORNER RADIUS KÖŞE YARIÇAPI	CHIP BREAKER TALAŞ KIRICI FORM MT: MEDIUM TURNING MT: ORTA TORNALAMA MR: MEDIUM PROFILING MR: ORTA PROFİLLEME	AKKO	A: GENERAL / GENEL P: STEEL / ÇELİK K: CAST IRON / DÖKÜM M: STAINLESS STEEL / PASLANMAZ S: HEAT RESISTANT ALLOYS / TITANIUM ISIYA DAYANIKLI ALAŞIMLAR / TİTANYUM N: NON-FERROUS METARIALS DEMİR OLMAYAN METALLER H: HARDENED STEEL / SERT METAL	GRADE / SERTLİK

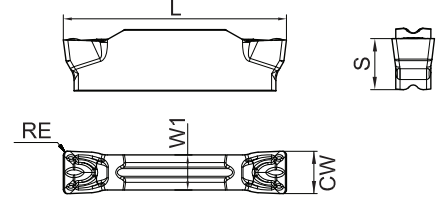

## AGD-MT

AKKO Çift Taraflı Kesme Uçları  
AKKO Grooving Double Side  
AKKO Nuten beidseitig

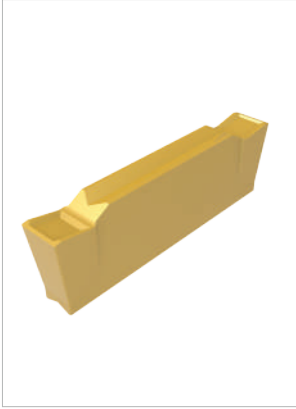

Sipariş Kodu Ordering Code Bestellungsnummer	Ölçü / Dimension (mm) / Dimension					Kalite / Grade / Qualität		
	CW±0.05	RE±0.05	L	W1	S	AP1225	AK1115	AA4230
AGD2002-MT	2.0	0.2	16.0	1.2	3.5	●	●	●
AGD2502-MT	2.5	0.2	18.5	2.0	3.85	●	●	●
AGD3004-MT	3.0	0.4	21.2	2.35	4.8	●	●	●
AGD4004-MT	4.0	0.4	21.0	3.3	4.8	●	●	●
AGD5004-MT	5.0	0.4	26.0	4.1	5.8	●	●	●
AGD5008-MT	5.0	0.8	26.0	4.1	5.8	●	●	●
AGD6004-MT	6.0	0.4	26.0	5.0	5.8	●	●	●
AGD6008-MT	6.0	0.8	26.0	5.0	5.8	●	●	●
AGD8008-MT	8.0	0.8	31.0	6.0	6.5	●	●	●

● Stok ○ Talep Edilmesi Halinde Üretilecek  
Stock Available upon order

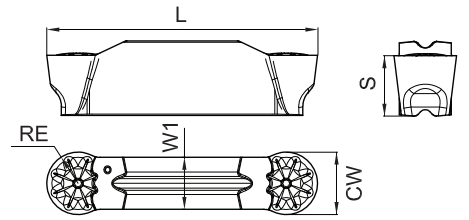

## AGD-MR

AKKO Çift Taraflı Kesme Uçları  
AKKO Grooving Double Side  
AKKO Nuten beidseitig

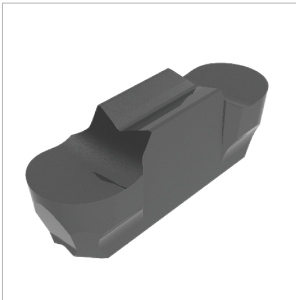

Sipariş Kodu Ordering Code Bestellungsnummer	Ölçü / Dimension (mm) / Dimension					Kalite / Grade / Qualität			
	CW±0.05	RE±0.05	L	W1	S	AP1105	AP1225	AK1115	AA4230
AGD2010-MR	2.0	1.0	16.0	1.2	3.5	●	●	●	●
AGD3015-MR	3.0	1.5	21.2	2.35	4.8	●	●	●	●
AGD4020-MR	4.0	2.0	21.0	3.3	4.8	●	●	●	●
AGD5025-MR	5.0	2.5	26.0	4.1	5.8	●	●	●	●
AGD6030-MR	6.0	3.0	26.0	5.0	5.8	●	●	●	●
AGD8040-MR	8.0	4.0	31.0	6.0	6.5	●	●	●	●

● Stok ○ Talep Edilmesi Halinde Üretilecek  
Stock Available upon order

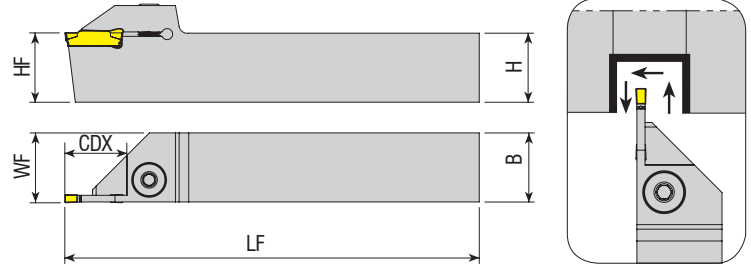

Takım Kodu Ordering Code Bestell-Bezeichnung	Stok Stock		Takım Ölçüleri (mm) Dimension (mm)				Kesici Uç Insert	Yedek Parçaları / Spare Parts			
	R	L	HF=H	B	LF	WF		CDX	Sıkma Vidası Screw	Pul Stamp	Anahtar Allen Key
ADKT-K-R/L-1212-1.5-T15	●	●	12	12	100	12.2	15	MGM. - 1.5	AKV-02-M6x22	ABPL-01	AAL-03-3
ADKT-K-R/L-2020-1.5-T15	●	●	20	20	125	20.2	15				
ADKT-K-R/L-1212-2-T15	●	●	12	12	100	16.3	15				
ADKT-K-R/L-1616-2-T10	●	●	16	16	125	16.3	10				
ADKT-K-R/L-1616-2-T15	●	●	16	16	125	16.3	15				
ADKT-K-R/L-2020-2-T15	●	●	20	20	150	20.3	15				
ADKT-K-R/L-2525-2-T15	●	●	25	25	150	25.3	15				
ADKT-K-R/L-3232-2-T15	●	●	32	32	170	32.3	15				
ADKT-K-R/L-1212-3-T15	●	●	12	12	100	12.3	15				
ADKT-K-R/L-1616-3-T15	●	●	16	16	125	16.3	15				
ADKT-K-R/L-2020-3-T10	●	●	20	20	125	20.3	10				
ADKT-K-R/L-2020-3-T20	●	●	20	20	125	20.3	20				
ADKT-K-R/L-2020-3-R28	●	●	20	20	125	20.3	28				
ADKT-K-R/L-2525-3-T10	●	●	25	25	150	25.3	10				
ADKT-K-R/L-2525-3-R15	●	●	25	25	150	25.3	15				
ADKT-K-R/L-2525-3-T22	●	●	25	25	150	25.3	22				
ADKT-K-R/L-3232-3-T10	●	●	32	32	170	32.3	10				
ADKT-K-R/L-3232-3-T22	●	●	32	32	170	32.3	22				
ADKT-K-R/L-2020-4-T10	●	●	20	20	125	20.4	10				
ADKT-K-R/L-2020-4-T20	●	●	20	20	125	20.4	20				
ADKT-K-R/L-2020-4-R25	●	○	20	20	125	20.4	25				
ADKT-K-R/L-2525-4-T10	●	●	25	25	150	25.4	10				
ADKT-K-R/L-2525-4-T18	●	●	25	25	150	25.4	18				
ADKT-K-R/L-2525-4-T22	●	●	25	25	150	25.4	22				
ADKT-K-R/L-3232-4-T10	●	●	32	32	170	32.4	10				
ADKT-K-R/L-3232-4-T22	●	●	32	32	170	32.4	22				
ADKT-K-R/L-2020-5-T20	●	●	20	20	125	20.5	20				
ADKT-K-R/L-2525-5-T15	●	●	25	25	150	25.5	15				
ADKT-K-R/L-2525-5-T18	●	●	25	25	150	25.5	18				
ADKT-K-R/L-2525-5-T25	●	●	25	25	150	25.5	25				
ADKT-K-R/L-3232-5-T15	●	●	32	32	170	32.5	15				
ADKT-K-R/L-3232-5-T25	●	●	32	32	170	32.5	25				
ADKT-K-R/L-2525-6-T15	●	●	25	25	150	25.6	15				
ADKT-K-R/L-2525-6-T25	●	●	25	25	150	25.6	25				
ADKT-K-R/L-3232-6-T25	●	●	32	32	170	32.6	25				
ADKT-K-R/L-3232-8-T32	●	●	32	32	170	32.8	32	AGD. - 8 / MGM. - 8			

R: Sağ / Right L: Sol / Left  
● Stokta / In Stock ○ Stokta Yok / Non Stock Item

Sipariş Örneği/Ordering Example/Bestellbeispiel  
1 ad./pcs. /stück ADKT-K-R-1212-1.5-T15

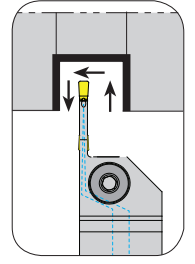
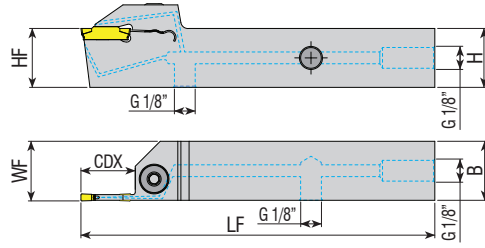

Takım Kodu Ordering Code Bestell-Bezeichnung	Stok Stock		Takım Ölçüleri (mm) Dimension (mm)				Kesici Uç Insert	Yedek Parçaları / Spare Parts			
	R	L	HF=H	B	LF	WF		CDX	Sıkma Vidası Screw	Pul Stamp	Anahtar Allen Key
ADKT-K-R/L-2020-3-T20-H	●	●	20	20	125	20.4	20	AGD. - 3 MGM. - 3	2004-M8x1x20	-	AAL-05-4
ADKT-K-R/L-2525-3-T22-H	●	●	25	25	150	25.4	22				
ADKT-K-R/L-2020-4-T20-H	●	●	20	20	125	20.4	20	AGD. - 4 MGM. - 4	2004-M8x1x20	-	AAL-05-4
ADKT-K-R/L-2525-4-T22-H	●	●	25	25	150	25.4	22				
ADKT-K-R/L-2525-5-T25-H	●	●	25	25	150	25.5	25	AGD. - 5 / MGM. - 5			

DIŞ ÇAP KANAL AÇMA İSVİÇRE TİPİ KAYAR OTOMAT MAKİNA TAKIMLARI  
**EXTERNAL GROOVING TOOLHOLDERS FOR SWISS TYPE SLIDING AUTOMATIC LATHES** ◀  
**WERKZEUGE ZUR STECHBEARBEITUNG AUF LANGDREHAUTOMATEN**

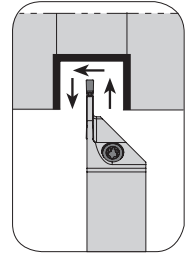
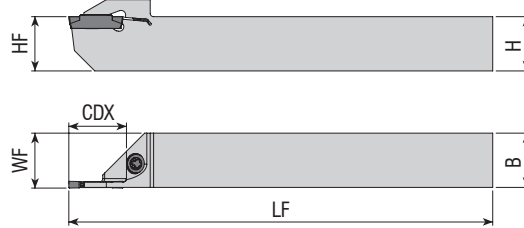

Takım Kodu Ordering Code Bestell-Bezeichnung	Stok Stock		Takım Ölçüleri (mm) Dimension (mm)				Kesici Uç Insert	Yedek Parçaları / Spare Parts			
	R	L	HF=H	B	LF	WF		CDX	Sıkma Vidası Screw	Pul Stamp	Anahtar Allen Key
ADKT-K-R/L-1212-2-R12-K-S	●	●	12	12	125	12.20	12	AGD. - 2 MGM. - 2	4015-M4x11	-	80-T15
ADKT-K-R/L-1616-2-R16-K-S	●	●	16	16	125	16.20	16				
ADKT-K-R/L-1212-3-R12-K-S	●	●	12	12	125	12.30	12	AGD. - 3 MGM. - 3	4015-M4x11	-	80-T15
ADKT-K-R/L-1616-3-R16-K-S	●	●	16	16	125	16.30	16				

Sipariş Örneği/Ordering Example/Bestellbeispiel  
1 ad./pcs./stück ADKT-K-R/L-2020-3-T20-H



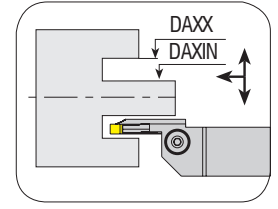
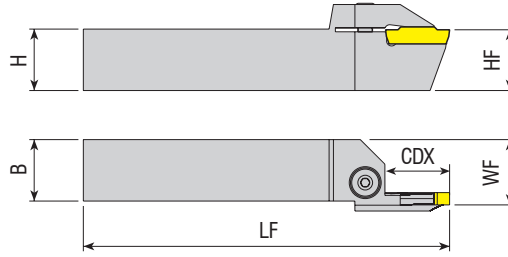

Takım Kodu Ordering Code Bestell-Bezeichnung	Stok Stock		Takım Ölçüleri (mm) Dimension (mm)							Kesici Uç Insert	Yedek Parçaları / Spare Parts		
	R	L	HF=H	B	LF	WF	CDX	DAXIN	DAXX		Sıkma Vidası Screw	Pul Stamp	Anahtar Allen Key
AAKT-K-R/L-2525-34-45-3-T17	●	●	25	25	150	26.5	17	34	45	AGD. - 3 MGM. - 3			
AAKT-K-R/L-2525-39-55-3-T17	●	●	25	25	150	26.5	17	39	55				
AAKT-K-R/L-2525-49-80-3-T17	●	●	25	25	150	26.5	17	49	80				
AAKT-K-R/L-2525-70-110-3-T17	●	●	25	25	150	26.5	17	70	110				
AAKT-K-R/L-2525-100-150-3-T17	●	●	25	25	150	26.5	17	100	150				
AAKT-K-R/L-2525-80-180-3-T32	●	●	25	25	150	26.5	32	80	180				
AAKT-K-R/L-2525-175-215-3-T22	●	●	25	25	150	26.5	22	175	215				
AAKT-K-R/L-2525-700-800-3-T17	●	●	25	25	150	26.5	17	700	800				
AAKT-K-R/L-2525-50-85-4-T22	●	●	25	25	150	26.5	22	50	85	AGD. - 4 MGM. - 4	2004-M8x1x20	-	AAL-05-4
AAKT-K-R/L-2525-70-110-4-T22	●	●	25	25	150	26.5	22	70	110				
AAKT-K-R/L-2525-100-150-4-T22	●	●	25	25	150	26.5	22	100	150				
AAKT-K-R/L-2525-80-180-4-T32	●	●	25	25	150	26.5	32	80	180				
AAKT-K-R/L-2525-180-800-4-T32	●	●	25	25	150	26.5	32	180	800				
AAKT-K-R/L-2525-70-110-5-T25	●	●	25	25	150	26.5	25	70	110	AGD. - 5 MGM. - 5			
AAKT-K-R/L-2525-100-150-5-T25	●	●	25	25	150	26.5	25	100	150				
AAKT-K-R/L-2525-80-180-5-T32	●	●	25	25	150	26.5	32	80	180				
AAKT-K-R/L-2525-140-200-5-T25	●	●	25	25	150	26.5	25	140	200				
AAKT-K-R/L-2525-180-800-5-T32	●	●	25	25	150	26.5	32	180	800				
AAKT-K-R/L-2525-60-100-6-T25	●	●	25	25	150	26.5	25	60	100	AGD. - 6 MGM. - 6			
AAKT-K-R/L-2525-60-100-6-T35	●	○	25	25	150	26.5	35	60	100				
AAKT-K-R/L-2525-100-200-6-T25	●	○	25	25	150	26.5	25	100	200				
AAKT-K-R/L-2525-100-200-6-T35	●	○	25	25	150	26.5	35	100	200				
AAKT-K-R/L-2525-100-200-6-T45	●	○	25	25	150	26.5	45	100	200				
AAKT-K-R/L-2525-140-300-6-T35	●	●	25	25	150	26.5	35	140	300				
AAKT-K-R/L-2525-140-300-8-T35	●	○	25	25	150	26.5	35	140	300	AGD. - 8 MGM. - 8			
AAKT-K-R/L-3232-140-350-8-T35	●	○	32	32	150	33.5	35	140	350				

R: Sağ / Right L: Sol / Left  
● Stokta / In Stock ○ Stokta Yok / Non Stock Item

Sipariş Örneği/Ordering Example/Bestellbeispiel  
1 ad./pcs./stück AAKT-K-R-2525-34-45-3-T17

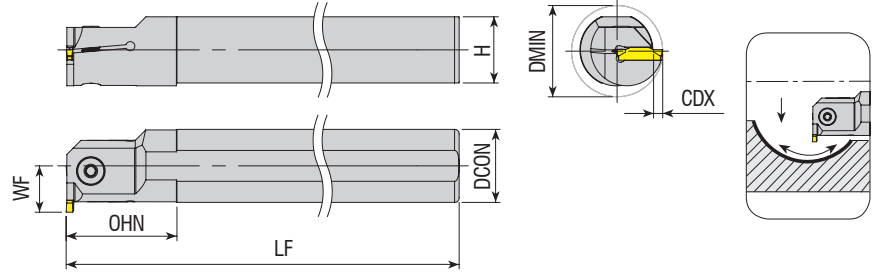

Takım Kodu Ordering Code Bestell-Bezeichnung	Stok Stock		Takım Ölçüleri (mm) Dimension (mm)							Kesici Uç Insert	Yedek Parçaları / Spare Parts	
	R	L	DCON	DMIN	LF	OHN	CDX	H	WF		Sıkma Vidası Screw	Anahtar Allen Key
AIKT-K-R/L-16-2-T4	●	●	16	21	150	28	4	14.8	12	AGD. - 2 MGM. - 2	2503-M4x10	AAL-03-3
AIKT-K-R/L-20-2-T4	●	●	20	25	170	30	4	18.3	14		2503-M4x12	
AIKT-K-R/L-25-2-T6	●	●	25	32	200	40	6	23	18.5	AGD. - 3 MGM. - 3	2504-M5x12	AAL-05-4
AIKT-K-R/L-20-3-T6	●	●	20	27	170	30	6	18.3	16		2504-M5x12	
AIKT-K-R/L-20-3-T7	●	●	20	25	170	38	7	18.3	13		2504-M5x16	
AIKT-K-R/L-25-3-T6	●	●	25	32	200	40	6	23	18.5		2004-M8x1x20	
AIKT-K-R/L-25-3-T10	●	●	25	32	200	48	10	23	17		2504-M5x12	
AIKT-K-R/L-32-3-T6	●	●	32	39	250	50	6	30	22		2504-M5x16	
AIKT-K-R/L-32-3-T12	●	●	32	39	250	53	12	30	22		2004-M8x1x20	
AIKT-K-R/L-40-3-T6	●	●	40	47	300	55	6	37.5	26		2504-M5x12	
AIKT-K-R/L-40-3-T12	●	○	40	48	300	63	12	37.5	27		2504-M5x16	
AIKT-K-R/L-20-4-T6	●	●	20	27	170	30	6	18.3	16		AGD. - 4 MGM. - 4	
AIKT-K-R/L-20-4-T7	●	○	20	25	170	38	7	18.3	13	2504-M5x12		
AIKT-K-R/L-25-4-T6	●	●	25	32	200	40	6	23	18.5	2504-M5x16		
AIKT-K-R/L-25-4-T10	●	●	25	32	200	49	10	23	17	2004-M8x1x20		
AIKT-K-R/L-32-4-T6	●	●	32	39	250	50	6	30	22	2504-M5x12		
AIKT-K-R/L-32-4-T12	●	●	32	39	250	53	12	30	22	2504-M5x16		
AIKT-K-R/L-40-4-T6	●	●	40	47	300	55	6	37.5	26	2004-M8x1x20		
AIKT-K-R/L-40-4-T12	●	●	40	48	300	63	12	37.5	27	2504-M5x16		
AIKT-K-R/L-25-5-T7	●	●	25	33	200	40	7	23	19.5	AGD. - 5 MGM. - 5	AAL-05-4	
AIKT-K-R/L-32-5-T7	●	●	32	40	250	50	7	30	23			2504-M5x12
AIKT-K-R/L-40-5-T7	●	●	40	48	300	55	7	37.5	27			2504-M5x16
AIKT-K-R/L-40-5-T12	●	○	40	48	300	63	12	37.5	27			2004-M8x1x20

R: Sağ / Right L: Sol / Left  
● Stokta / In Stock ○ Stokta Yok / Non Stock Item

Sipariş Örneği/Ordering Example/Bestellbeispiel  
1 ad./pcs./stück. AIKT-K-R-16-2-T4

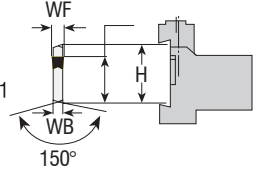
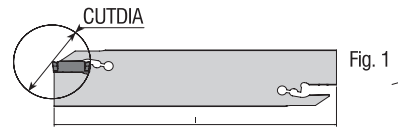
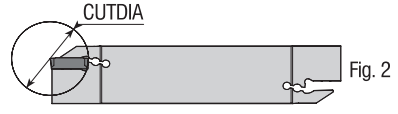
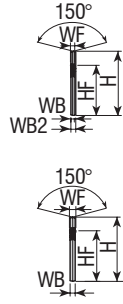

Takım Kodu Ordering Code Bestell-Bezeichnung	Stok Stock	Takım Ölçüleri (mm) Dimension (mm)							Kesici Uç Insert	Yedek Parçaları / Spare Parts	
		H	WF	WB2	WB	I	HF	CUTDIA		Anahtar Allen Key	
AKL-K-32-2	●	32	2	2.4	1.6	150	25	32	AGD. - 2 / MGM. - 2	ALA-02	
AKL-K-32-3	●	32	3	2.4	-	150	25	42	AGD. - 3 / MGM. - 3		
AKL-K-32-4	●	32	4	3.2	-	150	25	42	AGD. - 4 / MGM. - 4		



# BARALAR

AYARLI DELİK İŞLEME BARALARI  
ADJUSTABLE BORING HEADS  
EINSTELLBARE SPINDELKÖPFE

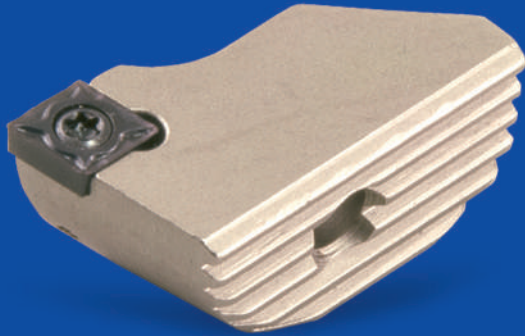



AKKO **A** **BH** **R** - **D18x22**

**W16** - **L90** - **CC06**

**2** Kesiş Stili / Cutter Style / Werkzeugtyp

BH : Delik İşleme / Boring Head  
Spindelkopf

**3** İşlem Tipi / Cutter Type / Einsatzgebiet

R : Kaba Baralama / Rough Boring  
Schruppbearbeitung  
F : Hassas Baralama / Fine Boring  
Schlichtbearbeitung

**5** Montaj Formu / Assembly Form / Schafform

W : Weldon

**4** Ölçü Aralığı / Boring Range / Bohrbereich

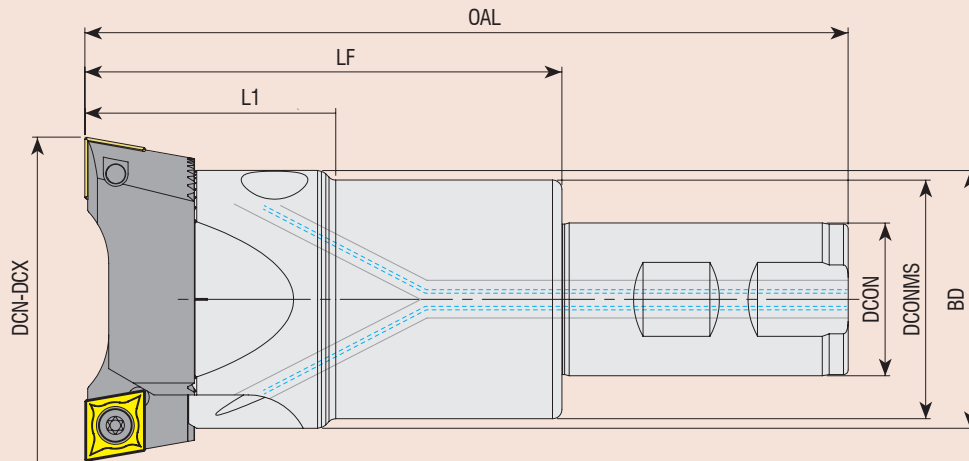

**6** Takım Boyu / Tool Length / Werkzeuglänge

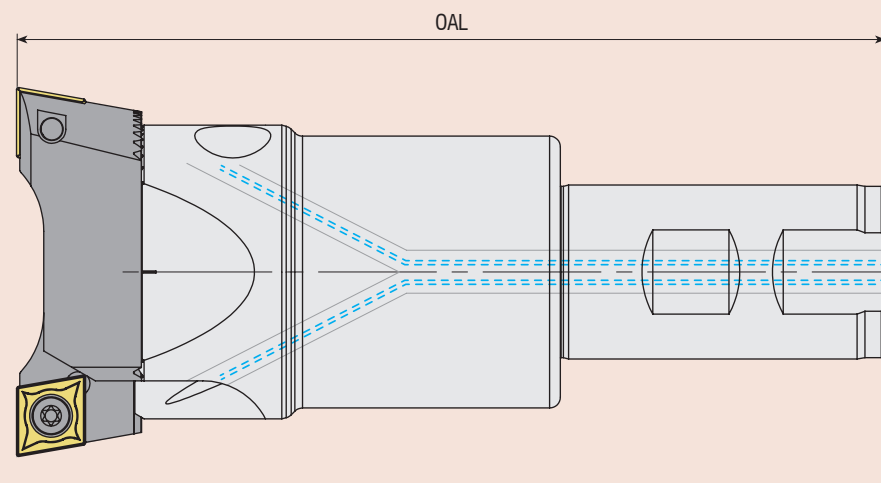

**7** Kesici Uç / Insert / Wendeschneidplatte

CC06 : CC.. 0602..  
CC09 : CC.. 09T3..  
CC12 : CC.. 1204..

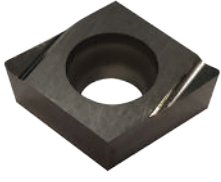

EDP	DESCRIPTION / AÇIKLAMA	CUTTING SPEED Vc=m/min KESME HIZI	FEED fn=mm/rev İLERLEME
T.01.08.03.01	CCGT 09T302L-AC1020	100-200	0.15~0.3
T.01.08.03.02	CCGT 09T304L-AC1020	100-200	0.2~0.4



EDP	DESCRIPTION / AÇIKLAMA	CUTTING SPEED Vc=m/min KESME HIZI	FEED fn=mm/rev İLERLEME
T.01.08.03.01	TPGH 09T0202L-AC1020	100-200	0.15~0.3
T.01.08.03.02	TPGH 09T0204L-AC1020	100-200	0.2~0.4



EDP	DESCRIPTION / AÇIKLAMA	CUTTING SPEED Vc=m/min KESME HIZI	FEED fn=mm/rev İLERLEME
T.01.08.03.01	WCGT 020102L-AC1020	100-200	0.05~0.2
T.01.08.03.02	WCGT 020104L-AC1020	100-200	0.08~0.3





*konusulan*  
*the spoken kalite...*  
*quality...*

[www.akkco.com.tr](http://www.akkco.com.tr)



