

High Performance Centres for Turning and Grinding

High performance live centres

Quick Find

S-Series

Standard centres (without spring loading) for high precision turning, CNC turning and cylindrical grinding

Technical information

Typ S/SG
60°

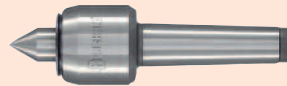

Typ SKOP/SKOPG
60°/40°

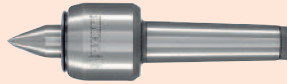

Typ SH/SHG
60° with carbide insert

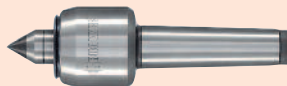

Typ SV/SVG
60° full carbide with **sa.co**® safety core

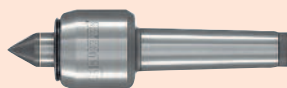

Typ SE/SEG
for interchangeable inserts

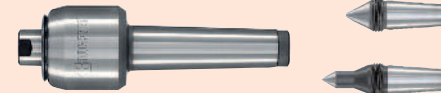

A-Reihe
with draw-off thread

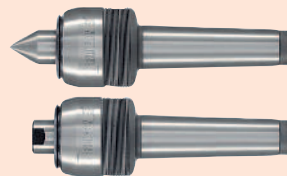

NC-Reihe

Live centres without spring loading, for turning, high speed CNC turning. Incorporating TOP-SEAL sealing system





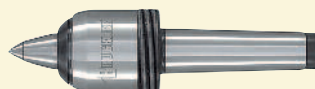

Technical information



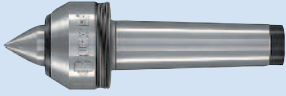
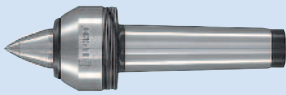



Typ NC
60°/40°

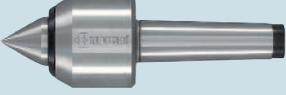

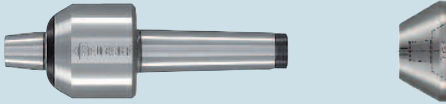

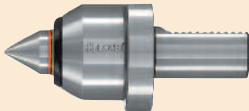

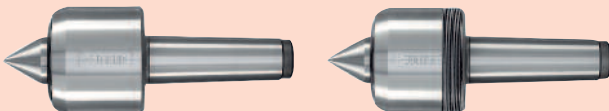
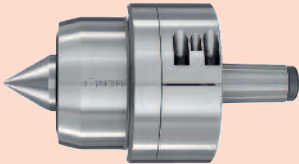
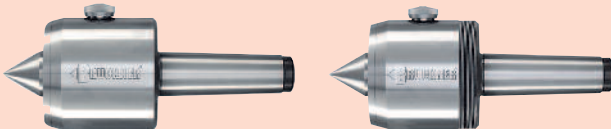

















Typ NCE
for interchangeable inserts

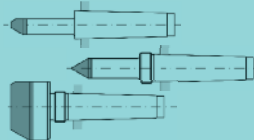
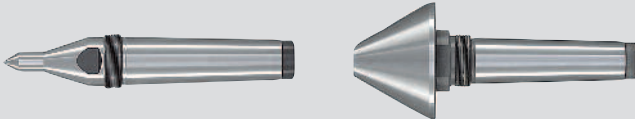

LK-Series	Live centres without spring loading for high performance turning, hard turning and cylindrical grinding. High stiffness due to short design and optimised bearing arrangement	Technical information	Page 22
Typ LKS 60°		Page 23	
Typ LKV 60°/40°		Page 24	
Typ LKH 60° with carbide insert		Page 25	
BÖKO-Series		Centres without spring loading for turning and CNC turning	
Type 2000 60°		Page 26	
Typ 2030 60°/30°		Page 27	
LR/LD-Reihe		Spring loaded centres. LR: with pressure indication for turning, CNC turning, for multi-spindle machines, face driver applications LD: without pressure indication for turning, CNC turning, with expansion compensation	
Technical information		Page 28/29	
Typ LRS 60°		Page 30	
Typ LRV 60°/40°		Page 31	
Typ LRE for interchangeable inserts		Page 32/33	
Typ LDS 60°		Page 34	

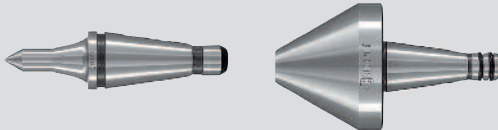
<p>Typ LDA for tapered caps</p>		<p>Page 35</p>
<p>Typ LDE for interchangeable inserts</p>		<p>Page 36/37</p>
<p>T-Linie</p> <p>Spring loaded centres with pressure indication for CNC lathes without tailstock and CNC lathes with opposed spindles</p> <p>Technical information</p> <p>Page 38</p>		
<p>VDI 60°, 60°/40° and for centering inserts</p>		<p>Page 39</p>
<p>CAPTO 60°, 60°/40° and for centering inserts</p>		<p>Page 40</p>
<p>Zylinderschaft for interchangeable inserts</p>		<p>Page 41</p>
<p>for heavy-duty machining for turning and cylindrical grinding</p> <p>M Series Centrepoint without spring loading</p> <p>MZ Series Centrepoint with spring loading and pressure indication</p> <p>Technical information</p> <p>Page 42/43</p>		
<p>Typ M/MG Typ AM/AMG 60°, 75°, 90°</p>		<p>Page 44</p>
<p>Typ MR/MRG 60°, 75°, 90° for interchangeable inserts</p>		<p>Page 45</p>
<p>Typ MZ/AMZ 60°, 75°, 90°</p>		<p>Page 46/47</p>
<p>Typ MZR 60°, 75°, 90° with tailstock sleeve support</p>		<p>Page 46/47</p>

ZA Series	High performance bullnose live centres for turning, cylindrical grinding of large bore workpieces	Page 48/49
Typ ZA/ZAG without draw-off thread 60°, 75°		Page 50/51
Typ ZA/ZAG with draw-off thread 60°, 75°		Page 52/53
Carbide dead centres Point angle 60°, out-of-roundness ≤ 0.8 μm	Technical information	Page 54/55
Form E, L		Page 56
Form V		Page 56
Form Z		Page 57
Form R		Page 57
Form B		Page 57
Form HB		Page 57
Forms HE, HL		Page 58
Form HS		Page 58
Form HV		Page 58
Form GE		Page 59
Form GV/GZ		Page 59

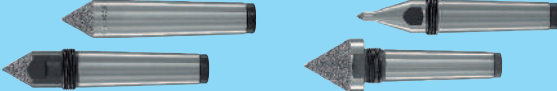
Form GR		Page 59
Form GHS		Page 60
Form GHV		Page 60
INES[®]	Interactive system to generate enquiry drawings for carbide dead centres	 Page 61
Tool steel dead centres with and without draw-off thread, point angle 60	Technical information	Page 62
Form 255/256/257/258 Morse taper metr. taper 1:20, taper 1:10		Page 63
Form 250 Morse taper metr. taper 1:20, taper 1:10		Page 64
Form 220/230 Steep taper 30/40		Page 65
Adapter sleeves for interchangeable inserts		Page 66
Reduction sleeves		Page 66
CARBIDOR[®] Coated driving centres	Technical information	 Page 67
Form 250CA/255CA 257CA/258CA		Page 68
Special Designs		
Tool steel dead centres		Page 64
Live sleeves Bullnose live centres		Page 69
High performance live centres		Page 70
Carbide dead centres		Page 71



Brochure 1940

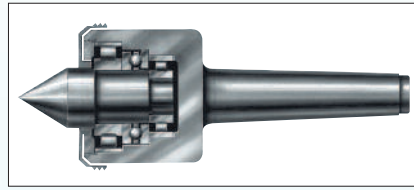

Rotating high performance centre for heavy-duty machining, with 2 roller bearings (1936)

> The Past

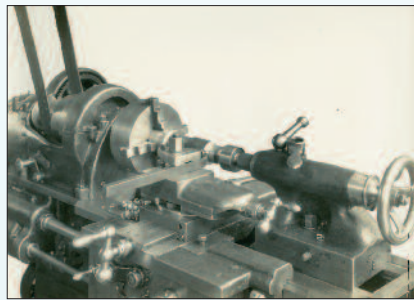

Lathe with rotating high performance centre from BRUCKNER



Company premises in Stuttgart 1920



New building 1963 in Weinstadt-Grossheppach



The founder, Karl Bruckner

In 1918 Karl Bruckner founded his engineering workshop in Stuttgart and laid the cornerstone for a success story which continues today – more than 90 years on. Initially the business focused on the repair and overhaul of machines but his ability to find innovative solutions to technical problems led him to rapidly obtain orders for his own designs of pedestal grinders and small lathes.

end of 1944 bombs had destroyed the factory, which he rebuilt under the very difficult conditions of 1945. In the following years Karl Georg focused on manufacturing and developing both live and dead centres. Diligently and ambitiously he expanded the company and its distribution network.



Karl-Georg Bruckner

He commenced manufacture of lathe centres and in 1920 as a pioneer in this field he developed and produced his first rotating tailstock centre.

The company's relocation to its present premises in Weinstadt-Grossheppach about 25 kilometers away was an important step for the company's future growth. In 1979 Karl Georg handed over management of the company to his daughter Hilde and his son Karl-Friedrich. In 1984 the youngest son Manfred joined the company and its management.

On the early death of Karl Bruckner in 1931 his son Karl Georg Bruckner took over management of the company. By the

> The Present

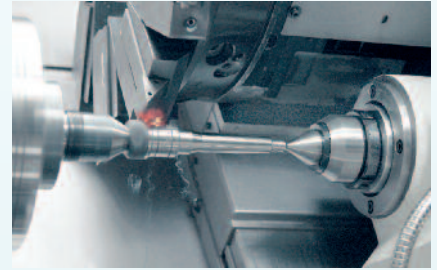
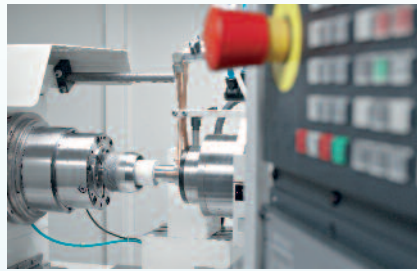

Administration building



Production halls



Measuring room



Concentricity testing

Today's product range well illustrates the unending Bruckner quest for perfection and precision.

A highly qualified and motivated staff is committed to fulfilling customer demands.

The application of high precision machine tools and the highest in-house standards of measurement have decisive influences on manufacturing.

So Bruckner products by their accuracy and durability directly contribute to the raising of productivity and achievement of international recognition.

Entrepreneurial activity, responsibility to employees and business partners, with commitment to innovation and uncompromising quality have been the decisive policy for the mission of this medium sized family owned company, these values being continuously passed to the fourth generation.

() = catalogue pages

Conventional turning

Operation requirements	Recommended series/types			
Workpiece accuracy ≥ 0.004 mm	S Series (9-15)		Bokö Series (26/27)	
Workpiece accuracy ≤ 0.003 mm	S Series 3μm (9-15)		LK Series 3μm (22-25)	
High workpiece surface finish	LK Series (22-25)			
Hard workpieces (hard turning)				
High live centre rigidity				
Elimination of or minimum vibrations during operation				
Heavy coolant flow	NC Series (18-21)			
High r.p.m. (> 5.000 1/min.)	NC Series (18-21)		LK Series (22-25)	
Long shafts	LR Series (28-33)		LD Series (34-37)	
Thermal expansion of workpiece due to machining	LR Series (28-33)		LD Series (34-37)	
Large workpiece centres/bores	ZA Series (48-53)		Type LDA (35)	
Variable clamping possibilities for different workpieces	Types SE/SEG	Type NCE	Type LRE	Type LDE
High rate of wear on the 60° centre point angle	(14/15)	(20/21)	(32/33)	(36/37)
Wear reduction on the 60° angle by carbide tipping	Types SH/SHG	Types SV/SVG	Types LKH/LKHG	
	(12)	(13)	(25)	
Tailstock without hydraulic force adjustment	LR Series (28-33)			
Controlling the axial force				
Face driver application with mechanical tailstock				
Face driver application with hydraulic tailstock				
Tailstock sleeve design prevents convenient removal of live centre	S Series (9-15)	LD Series (34-37)	NC Series (18-21)	
	A Series (16/17)	NC Series (18-21)	LK Series (22-25)	

CNC turning

Operation requirements	Recommended series/types			
Workpiece accuracy ≥ 0.004 mm	S Series (9-15)	NC Series (18-21)	Bokö Series (26/27)	
Workpiece accuracy ≤ 0.003 mm	S Series 3μm (9-15)		LK Series 3μm (22-25)	
High workpiece surface finish	LK Series (22-25)			
Hard workpieces (hard turning)				
Elimination of or minimum vibrations during operation				
Heavy coolant flow				
High r.p.m. (> 5.000 1/min.)	NC Series (18-21)		LK Series (22-25)	
Long shafts	LR Series (28-33)		LD Series (34-37)	
Thermal expansion of workpiece due to machining	LR Series (28-33)		LD Series (34-37)	
Large workpiece centres/bores	ZA Series (48-53)		Type LDA (35)	
Variable clamping possibilities for different workpieces	Types SE/SEG	Type NCE	Type LRE	Type LDE
High rate of wear on the 60° centre point angle	(14/15)	(20/21)	(32/33)	(36/37)
Wear reduction on the 60° angle by carbide tipping	Types SH/SHG	Types SV/SVG	Types LKH/LKHG	
	(12)	(13)	(25)	
Tailstock without hydraulic force adjustment	LR Series (28-33)			
Controlling the axial force				
Face driver application with mechanical tailstock				
Face driver application with hydraulic tailstock				
Compensation for varying centre depths and length tolerances of the workpiece at fixed preset tailstock and turret positions	LR Series (28-33)		T Line (38-41)	
Centre in second counter spindle	LR Series (28-33)		T Line (38-41)	
Tailstock sleeve design prevents convenient removal of live centre	A Series (16/17)	NC Series (18-21)	LK Series (22-25)	

Cylindrical grinding

() = catalogue pages

Operation requirements	Recommended series/types	
Workpiece accuracy	S Series 3µm with additional sealing (9-15)	LK Series 3µm (22-25)
High workpiece surface finish	LK Series 3µm (22-25)	
Elimination of or minimum vibrations during operation	LK Series 3µm (22-25)	
Heavy coolant flow	S Series 3µm, with additional sealing (9-15)	
Long shafts	S Series 3µm with additional sealing (9-15)	LK Series 3µm (22-25)
Large workpiece centres/bores	ZA Series 3µm (48-53)	
Variable clamping possibilities for different workpieces	Type SEG with additional sealing (14/15)	
Wear reduction on the 60° angle by carbide tipping	Type SHG with additional sealing (12)	Type SVG with additional sealing (13)
Tailstock sleeve design prevents convenient removal of live centre	A Series 3µm with additional sealing (16/17)	LK Series 3µm (22-25)

Heavy-duty machining

Characteristics/operation requirements	Recommended series/types	
Without tailstock sleeve support, without expansion compensation	Types M/MG, Types AM/AMG (44)	
Without tailstock sleeve support, with expansion compensation and pressure indication	Types MZ/AMZ (46/47)	
With tailstock sleeve support, without expansion compensation	Types MR/MRG (45)	
With tailstock sleeve support, with expansion compensation and pressure indication	Type MZR (46/47)	
High workpiece surface finish	Types MR/MRG (45)	Type MZR (46/47)
Thermal expansion of workpiece due to machining	Types MZ/AMZ (46/47)	
Large workpiece centres/bores	ZA Series (48-53)	
Tailstock sleeve design prevents convenient removal of live centre	Types AM/AMG (44)	Type AMZ (46/47)
Interrupted cut/out of balance workpiece	Types MR/MRG (45)	Type MZR (46/47)

Measuring/testing

Operation requirements	Recommended series/types		
Workpiece accuracy ≤ 0.003 mm and more	S Series 3µm (9-15)	LD Series 3µm (34-37)	
Long shafts	S Series 3µm (9-15)	LK Series 3µm (22-25)	
Large workpiece centres/bores	ZA Series 3µm (48-53)		
Variable clamping possibilities for different workpieces	Type SEG (14/15)		
Wear reduction on the 60° angle by carbide tipping	Type SHG (12)	Type SVG (13)	Type LKHG (25)
Tailstock sleeve design prevents convenient removal of live centre	A Series 3µm (16/17)	LK Series 3µm (22-25)	

BRUCKNER WORKS STANDARD

Our high performance live centres – standard as well as special designs – are produced and tested according to our works standard. Materials, production and testing are subject to strict quality guidelines guaranteeing function and performance of our tools.

Test report for concentricity accuracy

Every single BRUCKNER high performance live centre is tested for its runout under axial load. The test result is stamped into the high performance centre and is guaranteed by the test report.



Example: table „maximum runout“ for types S, SG

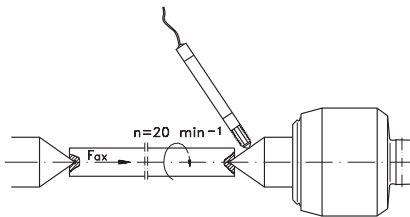

Type S	Type SG	Morse taper	Runout max.		Fax daN
			Type S	Type SG	
5001	5121	1	0.005	0.003	80
5001-2	5121-2	2	0.005	0.003	80
5001-3	5121-3	3	0.005	0.003	80
5002	5122	2	0.005	0.003	160
5003	5123	3	0.005	0.003	160
5006	5126	3	0.005	0.003	210
5004	5124	4	0.005	0.003	210
5007	5127	4	0.005	0.003	450
5005	5125	5	0.005	0.003	600
5008	5128	5	0.005	0.003	600
5009	5129	6	0.005	0.003	600

Tolerance of taper shank

The Morse taper is ground according to DIN 228 AT4 (gauge accuracy). This fine tolerance guarantees a close fit of the high performance centre in the tailstock and therefore the full utilisation of the concentricity accuracy.

Precision bearings

The bearing seats in the housing and on the centrepoint are precision-ground. The bearings and their seats are selected to fit.

Result: high stability, concentricity and long life.

Load values

The load values given in our tables are calculated with the world wide acknowledged software KISSsoft. When used in keeping with currently valid standards DIN and ISO, this software guarantees a safe and reliable load calculation.



Centrepoint

The centrepoint is of through-hardened alloy tool steel resistant to wear.

Housing

The housing is of alloy tool steel with high tensile strength. Housing head and shank are case-hardened for protection from damage.

Maintenance

The bearings are maintenance-free due to permanent lubrication.

Repair service

Our repair service is at your disposal for any repairs. We judge the tool's condition and inform you about the extent of necessary repairs.

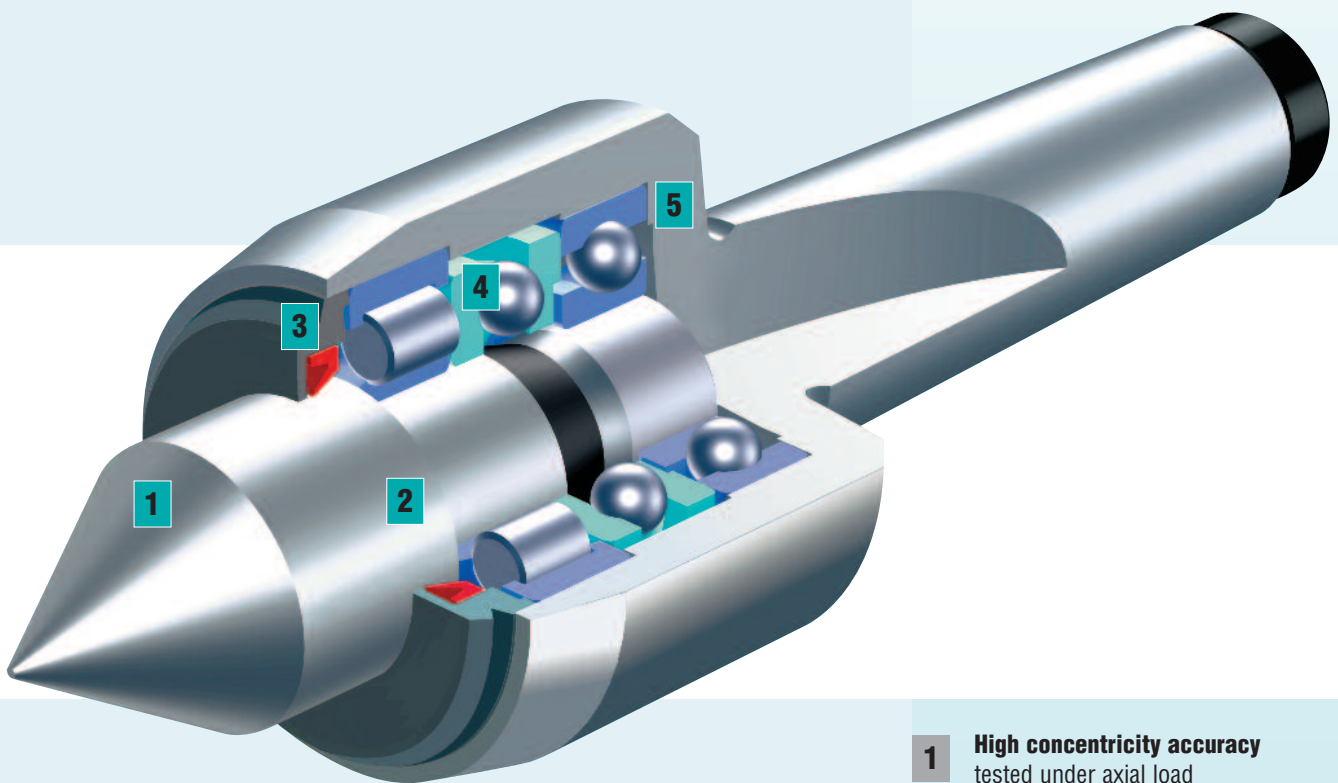

S Series – the classic design with head bearings

The all-rounder of our high performance live centres. The centres from our S series offer the user an economic solution for almost every standard workholding situation. From turning and cylindrical grinding to measuring and inspection, centres of the S series fulfil the high requirements of performance, precision and tool life.

Two types:

- ▶ Slim design for light-duty work
- ▶ With stronger bearings for normal to high-duty service

- 1 High concentricity accuracy**
tested under axial load
guaranteed with test report
- 2 Centrepoint**
of through-hardened alloy tool steel
- 3 Seal ring**
protects the bearings from dirt and coolant. Optionally available with supplementary seal (page 10)
- 4 Large-dimensioned precision roller bearings**
for supporting the radial and axial forces.
Maintenance-free due to permanent lubrication
- 5 Housing**
of high tensile alloy tool steel
housing and shank are case-hardened to protect from damage

Types S, SG

Centrepoint 60°

Runout

Type S max. 0.005 mm
 Type SG max. 0.003 mm

with test report

Application

- Type S** – conventional turning, CNC turning, roughing, finishing
- Type SG** – for turning and grinding operations demanding high accuracy, measuring

Supplementary seal

For operations involving heavy flows of coolant or large quantities of dust and dirt (e. g. cylindrical grinding), a supplementary seal can be fitted onto the centrepoint. The seal turns together with the centrepoint, seals the protection cap and additionally works as a splash ring.

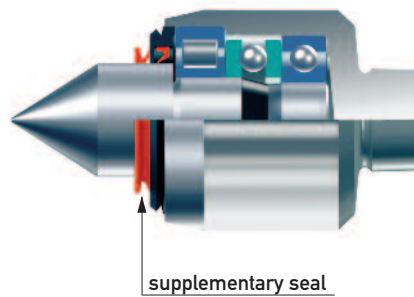
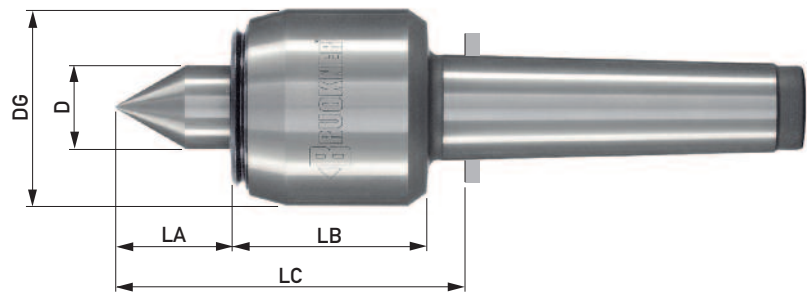

Type S	ID.No.	5001	5001-2	5001-3	5002	5003	5006	5004	5007	5005	5008	5009
Type SG	ID.No.	5121	5121-2	5121-3	5122	5123	5126	5124	5127	5125	5128	5129
Morse taper		1	2	3	2	3	3	4	4	5	5	6
D		13	13	13	20	20	25	25	35	45	58	58
DG		32	32	32	45	45	58	58	76	95	120	120
LA		19	19	19	24	24	34	34	43	59	63	63
LB		38	38	38	52	52	58	58	68	89	102	102
LC		63	63	64	82	83	99	101	120	159	178	178
Workpiece weight max. daN*		120	120	120	340	340	525	525	1000	2000	2500	3000
r.p.m. max.*		7000	7000	7000	5500	5500	5000	5000	4000	3500	2300	2300
Radial/axial load graph		R1/A1	R1/A1	R1/A1	R2/A2	R2/A2	R3/A3	R3/A3	R4/A4	R5/A5	R6.1/A6	R6.2/A6
Supplementary seal	ID.No.	V13	V13	V13	V20	V20	V25	V25	V35	V45	V58	V58

► With draw-off thread see pages 16/17

*observe the load graphs

Radial and axial loads for a bearing life of 2000 operating hours (calculation example on page 11)

Radial – Types S, SG

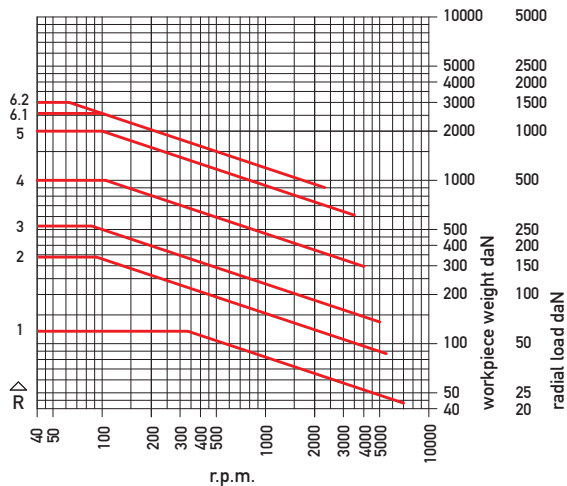

Axial – Types S, SG

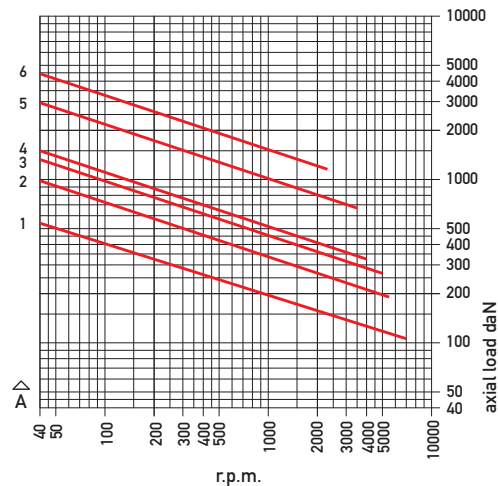

Types SKOP, SKOPG

Centrepoint 60°/40° extended

Runout

Type SKOP max. 0.005 mm
 Type SKOPG max. 0.003 mm
 with test report

Application

Whenever the working distance between centre and workpiece is confined. The extended, slim centrepoint can enlarge this space.

Type SKOP – conventional turning, CNC turning, roughing, finishing

Type SKOPG – for turning operations demanding high accuracy

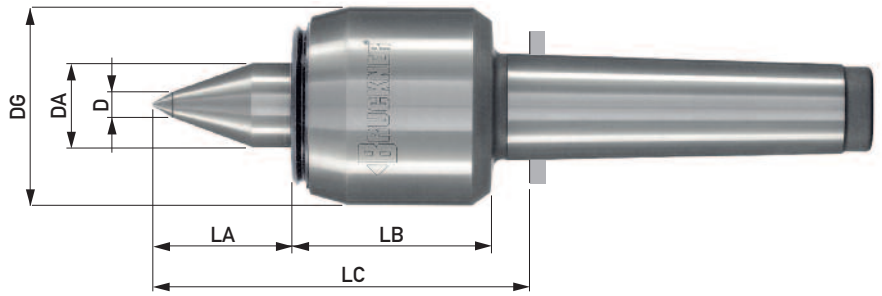

Type SKOP	ID.No.	5362	5363	5366	5364	5367	5365
Type SKOPG	ID.No.	5362G	5363G	5366G	5364G	5367G	5365G
Morse taper		2	3	3	4	4	5
DA		20	20	25	25	35	45
D		6	6	8	8	10	12
DG		45	45	58	58	76	95
LA		30	30	42	42	54	70
LB		51	51	58	58	68	89
LC		87	89	106	108	132	169
Workpiece weight max. daN*		280	280	420	420	850	1500
r.p.m. max.*		5500	5500	5000	5000	4000	3500
Radial/axial load graph		RK1/AK1	RK1/AK1	RK2/AK2	RK2/AK2	RK3/AK3	RK4/AK4
Supplementary seal	ID.No.	V20	V20	V25	V25	V35	V45

► With draw-off thread see pages 16/17

*observe the load graphs

Radial and axial loads for a bearing life of 2000 operating hours

Radial – Types SKOP, SKOPG

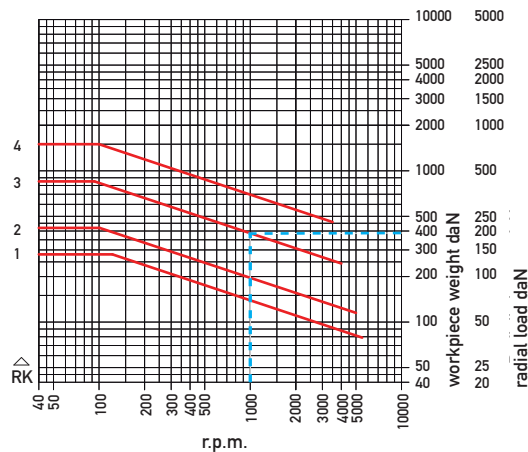

Axial – Types SKOP, SKOPG

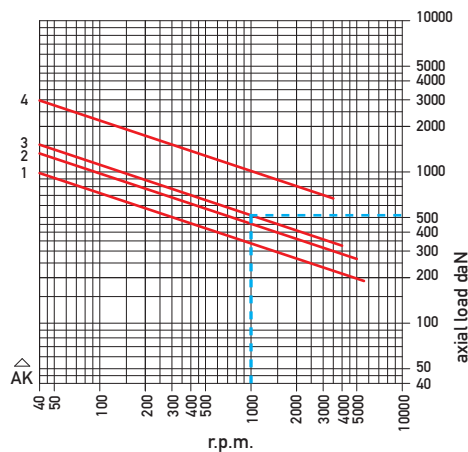

Determination of admissible load

Example: Type SKOP 5367, MT 4

Load graph: radial RK3/axial AK3
 Permissible load at 1000 r.p.m.
 Radial load $F_R = 190$ daN
 Workpiece weight $F_W = 380$ daN
 Axial load $F_A = 510$ daN
 The radial load F_R determines the radial load capacity of a centre.

$$F_R = \frac{F_W}{2} \pm \text{radial cutting forces} + \text{centrifugal force}^{**}$$

**for unbalanced workpieces
 (1 daN = 1,02 kp)

Types SH, SHG

Centrepoint 60° carbide-tipped

Regrindable to the regrinding line

Runout

Type SH max. 0.005 mm

Type SHG max. 0.003 mm

with test report

Application

For cylindrical grinding and turning operations during which additional stress is put on the centrepoint (e.g. large series, change of workpiece when spindle is turning, hard workpieces, extremely small workpiece centres).

For cylindrical grinding operations we recommend the use of our **supplementary seal** (fig. on page 10)

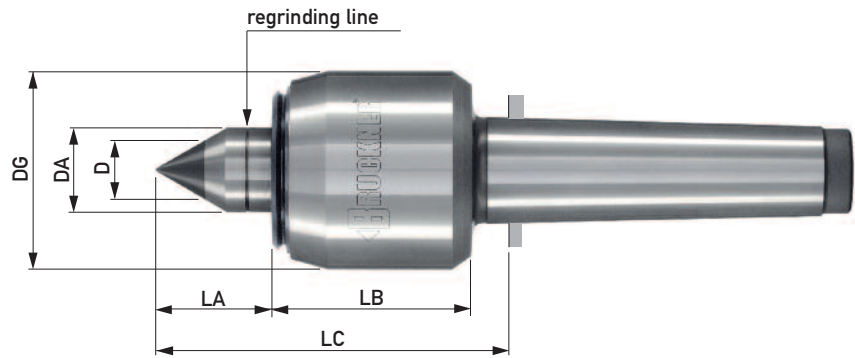

Type SH	ID.No.	5241-2	5241-3	5242	5243	5246	5244	5247	5245	5249
Type SHG	ID.No.	5251-2	5251-3	5252	5253	5256	5254	5257	5255	5259
Morse taper		2	3	2	3	3	4	4	5	6
DA		13	13	20	20	25	25	35	45	58
D		7	7	11	11	18	18	18	18	30
DG		32	32	45	45	58	58	76	95	120
LA		19	19	24	24	34	34	43	59	63
LB		38	38	52	52	58	58	68	89	102
LC		63	64	82	83	99	101	120	159	178
Workpiece weight max. daN*		120	120	200	200	400	400	600	1200	2100
r.p.m. max.*		7000	7000	5500	5500	5000	5000	4000	3500	2300
Radial/axial load graph		RH1/AH1	RH1/AH1	RH2/AH2	RH2/AH2	RH3/AH3	RH3/AH3	RH4/AH4	RH5/AH5	RH6/AH6
Supplementary seal	ID.No.	V13	V13	V20	V20	V25	V25	V35	V45	V58

MT1 5241/5251 on request

*observe the load graphs

► With draw-off thread see pages 16/17

Radial and axial loads for a bearing life of 2000 operating hours (calculation example on page 11)

Radial – Types SH, SHG

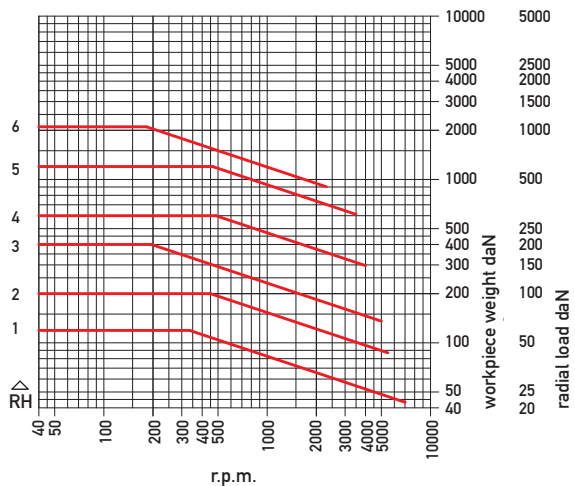

Axial – Types SH, SHG

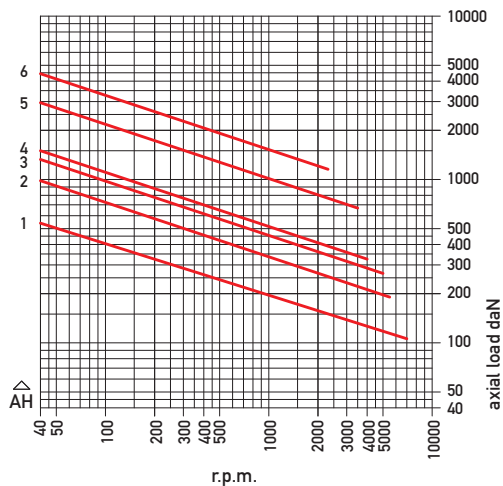

Types SV, SVG

Centrepoint 60° full carbide
with safety core **sa•co**[®]
Regrindable to the braze line

Runout

Type SV max. 0.005 mm
Type SVG max. 0.003 mm
with test report

Application

Same as type SH, SHG.
The point angle of 60° up to the large diameter can be utilised for loading workpieces.

For cylindrical grinding operations we recommend the use of our **supplementary seal** (fig. on page 10)

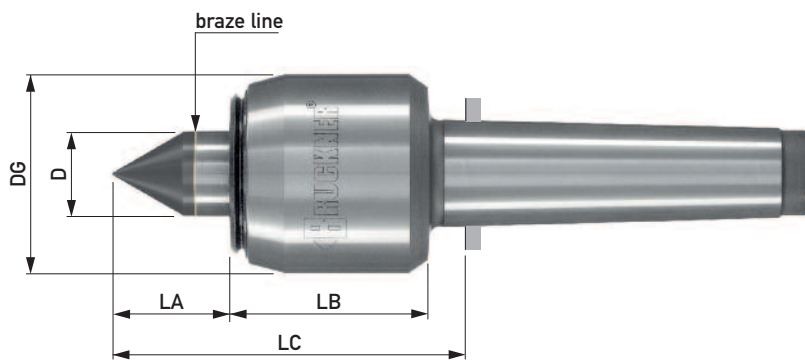

A safety core is integrated in the carbide point of types SV, SVG.
If the interface of carbide and basic material becomes overstressed, e.g. through operating error or mishandling, the safety core prevents the carbide with the loaded component from slipping. Thus high consequential damage is avoided.

Type SV	ID.No.	5242ZV20	5243ZV20	5246ZV25	5244ZV25	5247ZV35	5245ZV45
Type SVG	ID.No.	5252ZV20	5253ZV20	5256ZV25	5254ZV25	5257ZV35	5255ZV45
Morse taper		2	3	3	4	4	5
D		20	20	25	25	35	45
DG		45	45	58	58	76	95
LA		24	24	34	34	43	59
LB		52	52	58	58	68	89
LC		82	83	99	101	120	159
Workpiece weight max. daN*		100	100	250	250	400	600
r.p.m. max.*		5500	5500	5000	5000	4000	3500
Radial/axial load graph		RV1/AV1	RV1/AV1	RV2/AV2	RV2/AV2	RV3/AV3	RV4/AV4
Supplementary seal	ID.No.	V20	V20	V25	V25	V35	V45

*observe the load graphs

Radial and axial loads for a bearing life of 2000 operating hours (calculation example on page 11)

Radial – Types SV, SVG

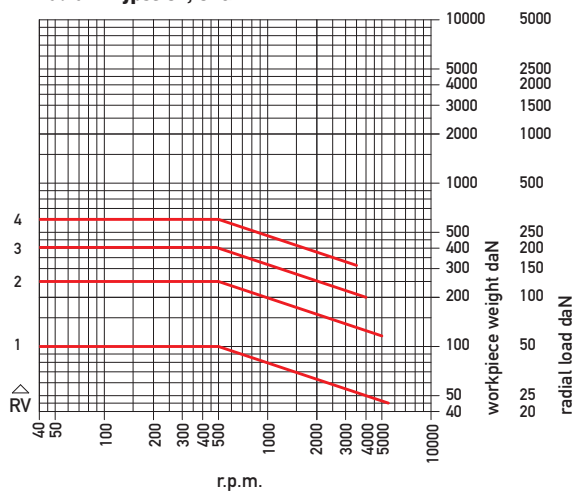

Axial – Types SV, SVG

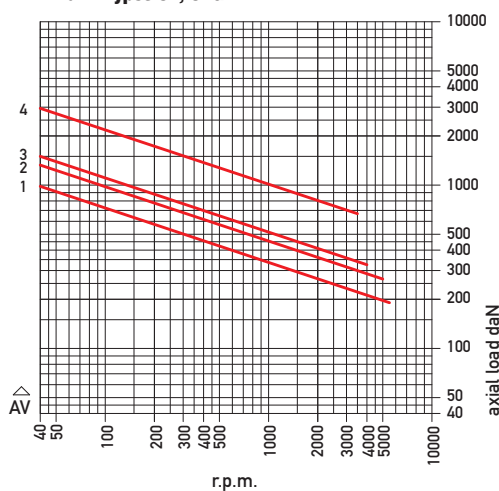

Types SE, SEG

Centre spindle with 1:7.5 internal taper for interchangeable inserts

Runout

Type SE max. 0.005 mm
Type SEG max. 0.003 mm

with test report

Application

For one off, small and large series production, measuring.

Advantages

As the centre spindle wears only the insert has to be changed and once again the high performance centre is ready for use. Flexibility in application is made possible by a choice of eight different insert styles (page 15).

Depending on the style the insert can be removed by its draw-off thread and draw-off nut or with spanners applied to the spanner flats.

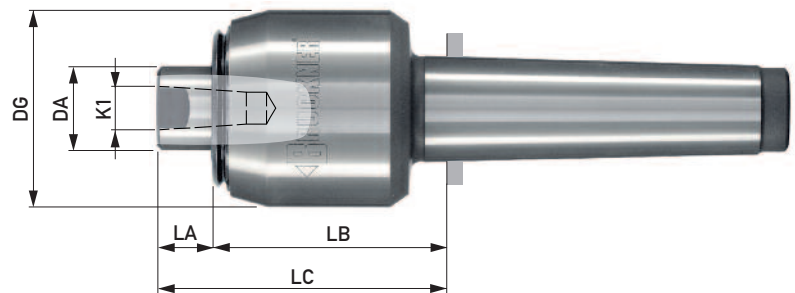

For cylindrical grinding operations we recommend the use of our **supplementary seal** (fig. on page 10)

Type SE	ID.No.	5482	5483	5486	5484	5487	5485
Type SEG	ID.No.	5482G	5483G	5486G	5484G	5487G	5485G
Morse taper		2	3	3	4	4	5
DA		20	20	25	25	35	45
DG		45	45	58	58	76	95
K1		11	11	15	15	22	28
LA		14	14	17	17	18	21
LB		52	52	58	58	68	89
LC		71	72	81	83	95	121
SW (spanner flat)		16	16	22	22	30	41
r.p.m. max.*		5500	5500	5000	5000	4000	3500
Suitable insert		482..	482..	484..	484..	487..	485..
Supplementary seal	ID.No.	V20	V20	V25	V25	V35	V45
Load	The load of types SE, SEG is limited by the interchangeable inserts (page 15)						

► With draw-off thread see pages 16/17

Adapter sleeve type KE

(figure and table: see page 66)
For regrinding interchangeable inserts. Combined with the interchangeable inserts, can be used as a dead centre in head- and tailstocks for special operations.

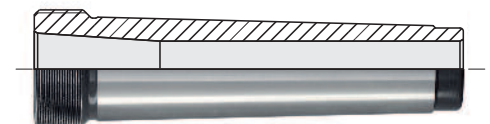

Interchangeable inserts

taper 1:7.5, in gauge accuracy

Form AO, 60°
draw-off thread

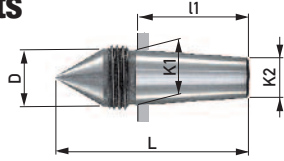

Form ASL, 60°
slim, extended
draw-off thread

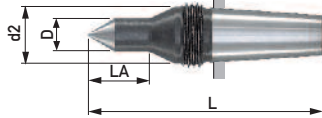

Form AKOP, 60°/40°
extended
draw-off thread

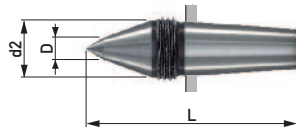

Form A, 60°
for hollow parts
spanner flat (SW)

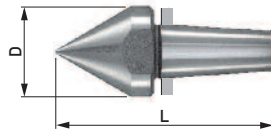

Form B, centre 60°
for centreless workpieces,
draw-off thread

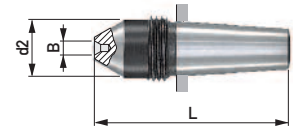

Form C, centre 60°
for centreless workpieces,
external angle 60° for hollow
parts, spanner flat (SW)

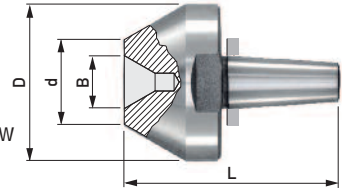

Form D, centre 60°
for centreless workpieces,
spanner flat (SW)

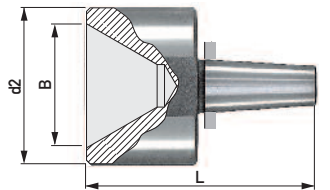

Form AOHM, 60°
with carbide insert
draw-off thread

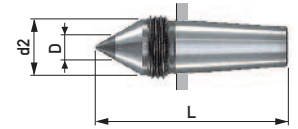

Basic centre Types: SE, SEG, ASE KE (page 66)	Interchangeable inserts	Radial load max. daN	Insert dimensions						Thread SW	Taper dimensions taper 1:7.5		
			D	d2	B	d	L	LA		K1	K2	I1
5482 5482G 5483 5483G 2952A	482AO	90	11.7				45		M 14x1.5	11	8	23
	482ASL	30	6	11.7			55	15	M 14x1.5			
	482AKOP	90	5	11.7			50		M 14x1.5			
	482A	90	17				45		SW14			
	482B	90		11.7	4x2		45		M 14x1.5			
	482C	90	28		8x3	12	45		SW24			
	482D	90		28	20x6		45		SW24			
	482AOHM	60	7	11.7			45		M 14x1.5			
5484 5484G 5486 5486G 5484A 5486A 2953A	484AO	160	15.7				53		M 18x1.5	15	11	30
	484ASL	100	9	15.7			65	17	M 18x1.5			
	484AKOP	160	6	15.7			58		M 18x1.5			
	484A	160	25				60		SW22			
	484B	110		15.7	4x2		53		M 18x1.5			
	484C	160	44		15x5	24	60		SW41			
	484D	160		44	35x12		64		SW41			
	484AOHM	60	7	15.7			53		M 18x1.5			
5487 5487G 5487A 2954A	487AO	300	21.6				74		M 24x1.5	22	16.4	42
	487ASL	100	9	21.6			86	17	M 24x1.5			
	487AKOP	300	8	21.6			80		M 24x1.5			
	487A	300	32				82		SW27			
	487B	240		21.6	5x2.5		74		M 24x1.5			
	487C	300	55		20x6	30	82		SW50			
	487D	300		55	45x15		85		SW50			
487AOHM	200	11	21.6			74		M 24x1.5				
5485 5485G 5485A 2955A	485AO	500	27.7				93		M 30x1.5	28	21	52.5
	485ASL	180	13	27.7			110	27	M 30x1.5			
	485AKOP	500	8	27.7			105		M 30x1.5			
	485A	500	45				105		SW41			
	485B	500		27.7	7x3		93		M 30x1.5			
	485C	500	65		25x6	35	105		SW55			
	485D	500		65	55x20		105		SW55			
485AOHM	500	18	27.7			93		M 30x1.5				

ID.No.	Content
P 10	100 g

Installation paste

Makes insert change easier.
Apply thinly and evenly to the insert taper.

Version A

with draw-off thread

Application

With blind tailstock sleeve (without the possibility to remove the centre via a through hole) or for high precision machine tools to protect the spindle bearings or the tailstock sleeve.

For cylindrical grinding operations we recommend the use of our **supplementary seal** (as shown on page 10).

Special draw-off nut

This nut assures centre removal from the tailstock even if the sleeve diameter is smaller than the centres housing diameter.

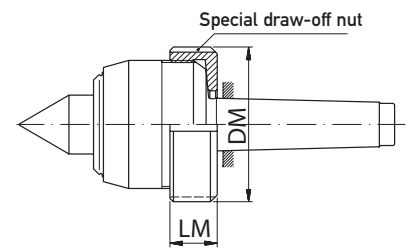

Types AS, ASG

60° centrepiece

Runout

Type AS max. 0.005 mm

Type ASG max. 0.003 mm

with test report

Technical data: see types S, SG (page 10)

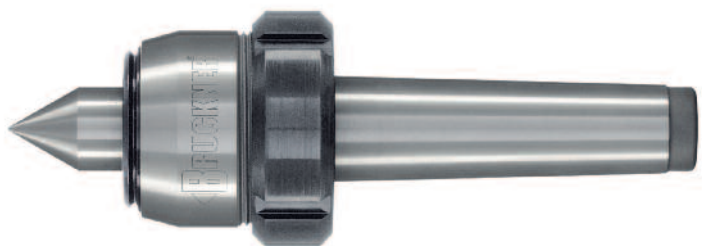

Type ASKOP

60°/40° centrepiece extended

Runout

max. 0.005 mm

with test report

Technical data: see type SKOP (page 11)



Type ASHG

60° centrepiece with carbide insert

Runout

max. 0.003 mm

with test report

Technical data: see type SHG (page 12)

Type ASVG on request



Type ASE

Centre spindle with 1:7.5 internal taper for interchangeable inserts

Runout

max. 0.005 mm

with test report

Technical data: see type SE (page 14), inserts (page 15)



Morse taper		3	4	4	5	6
Type AS	ID.No.	5006A	5004A	5007A	5005A	5009A
	radial/axial load graph	R3/A3	R3/A3	R4/A4	R5/A5	R6/A6
Type ASG	ID.No.	5126A	5124A	5127A	5125A	5129A
	radial/axial load graph	R3/A3	R3/A3	R4/A4	R5/A5	R6/A6
Type ASKOP	ID.No.	5366A	5364A	5367A	5365A	
	radial/axial load graph	RK3/A3	RK3/A3	RK4/A4	RK5/A5	
Type ASHG	ID.No.	5256A	5254A	5257A	5255A	
	radial/axial load graph	RH3/A3	RH3/A3	RH4/A4	RH5/A5	
Type ASE	ID.No.	5486A	5484A	5487A	5485A	
	load	The load of type ASE is limited by the interchangeable inserts (page 15)				
Supplementary seal	ID.No.	V25	V25	V35	V45	V58

Special nut for version A					
ID.No.	M58A	M58A	M76A	M95A	M120A
DM	70	70	92	115	138
LM	24	24	28	39	45

Radial and axial loads for a bearing life of 2000 operating hours (calculation example on page 11)

Radial – Types AS, ASG

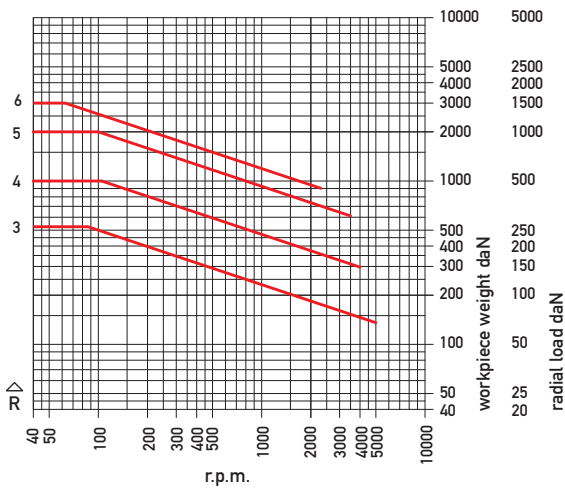

Radial – Type ASKOP

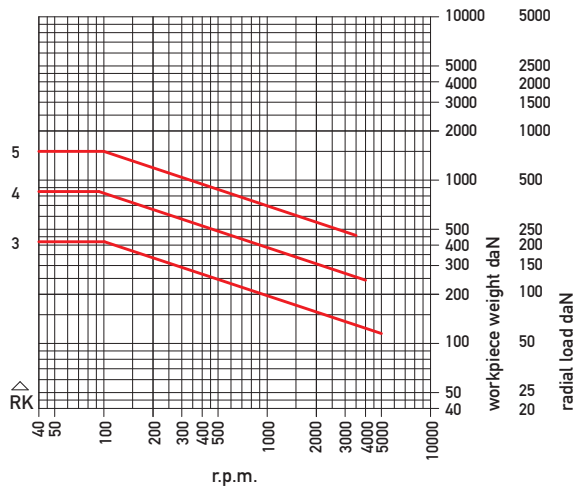

Radial – Type ASHG

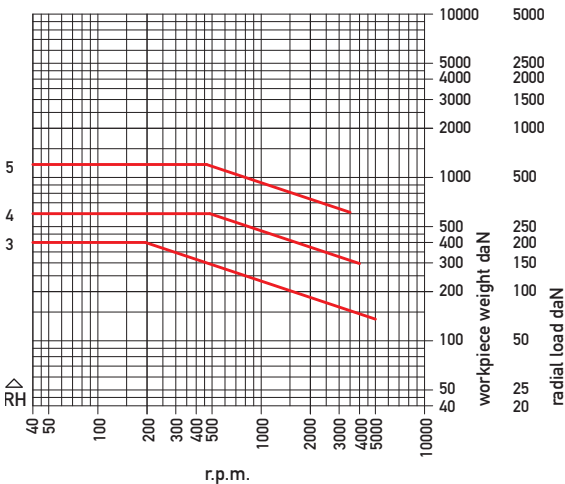

Axial – all A Types

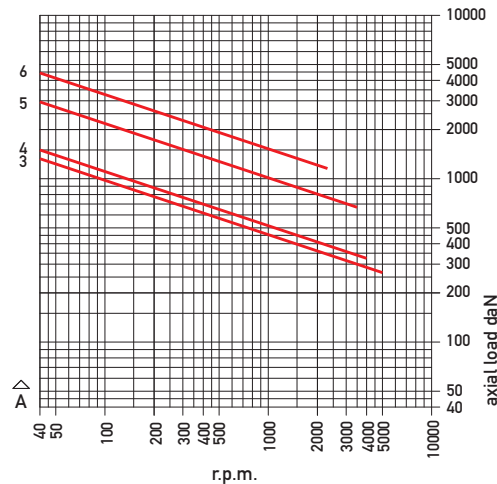

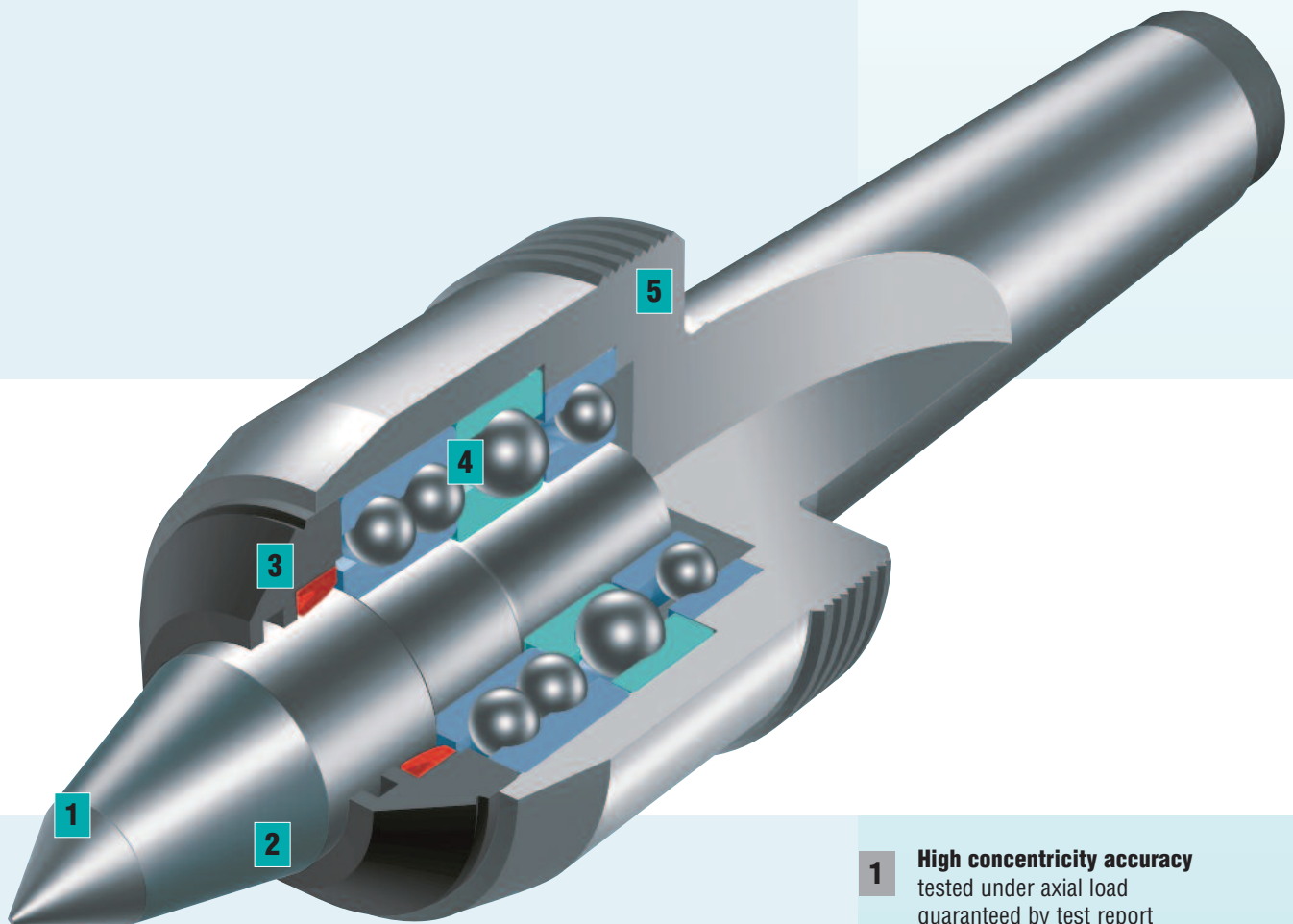

NC Series – a class on its own



The BRUCKNER TOP-SEAL-SYSTEM provides a triple-layer protection from dirt and coolant (see the principle on page 20). The robust precision bearings have been specially designed for turning operations requiring high

r.p.m. The NC series user works with high performance centres showing their class particularly when „the going gets tough“.

Two types:

- ▶ Slim design for ease of access, minimum rolling resistance for small and medium work through low-friction bearings
- ▶ With extra high duty bearings for higher loads

- 1 High concentricity accuracy**
tested under axial load
guaranteed by test report
- 2 Through-hardened alloy tool steel centrepoint**
- 3 TOP-SEAL-SYSTEM**
protects the bearings from dirt and coolant
- 4 Large-dimensioned precision roller bearings**
robust bearings to absorb the radial and axial forces.
Maintenance-free due to permanent lubrication
- 5 Housing**
of high tensile alloy tool steel.
Housing and shank are case-hardened to protect from damage

Types NC 33, NC 43

For high r.p.m.
Centrepoint 60°/40°
 with draw-off thread

Runout
 max. 0.005 mm, with test report

Application
 For turning operations requiring high r.p.m.
 Triple-layer protection of bearings from penetration of coolant by the **TOP-SEAL-SYSTEM** (principle on page 20)

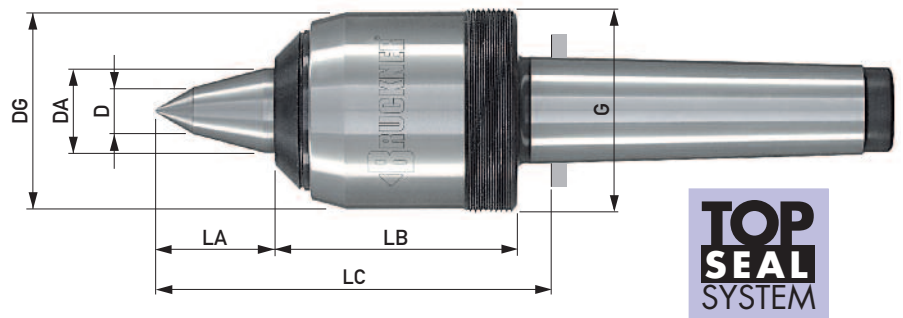

Type NC	ID.No.	33.045-2	33.045-3	43.058-3	33.058-4	43.076-4	33.076-5	43.095-5	33.095-6
Draw-off nut	ID.No.	M45A	M45A	M60	M60	M80	M80	M100	M100
Morse taper		2	3	3	4	4	5	5	6
DA		20	20	25	25	35	35	45	45
D		6	6	14	14	16	16	20	20
DG		45	45	58	58	76	76	95	95
LA		25	25	35	35	44	44	54	54
LB		57	57	70	70	81	81	103	103
LC		87	88	112	112	132	132	164	164
G		M 45x2	M 45x2	M 60x1.5	M 60x1.5	M 80x2	M 80x2	M 100x2	M 100x2
Workpiece weight max. daN*		280	280	500	500	1100	1300	2200	2200
r.p.m. max.*		8000	8000	7000	7000	6000	6000	5000	5000
Radial/axial load graph		RC1/AC1	RC1/AC1	RC2/AC2	RC2/AC2	RC3.1/AC3	RC3.2/AC3	RC4/AC4	RC4/AC4

The thread specifications of the ID.Nos. 33.045-2 and 33.045-3 are similar to that of version A, fitting the special nut for version A (page 16).

*observe the load graphs

Radial and axial loads for a bearing life of 2000 operating hours (calculation example on page 11)

Radial – Type NC

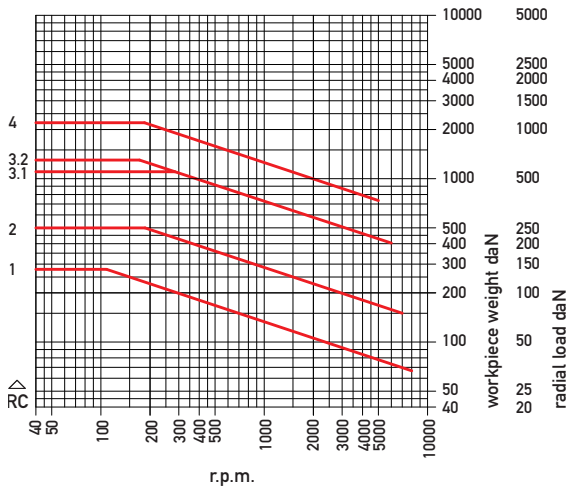

Axial – Type NC

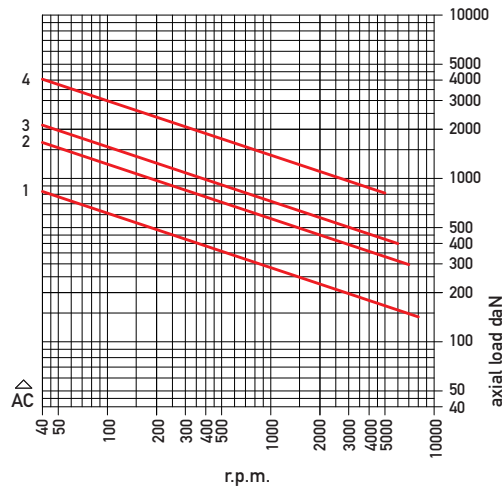

Types NCE 34, NCE 44

For high r.p.m
Centre spindle with internal taper 1:7.5
for interchangeable inserts
 with draw-off thread

Runout
 max. 0.005 mm, with test report

Application
 Variable clamping possibilities for CNC turning through interchangeable inserts. In the case of a collision or insert wear, type NCE offers the advantage that, simply by changing the insert, the high performance centre is immediately ready for use again.
 Multiple use is made possible by eight different insert styles (page 21).

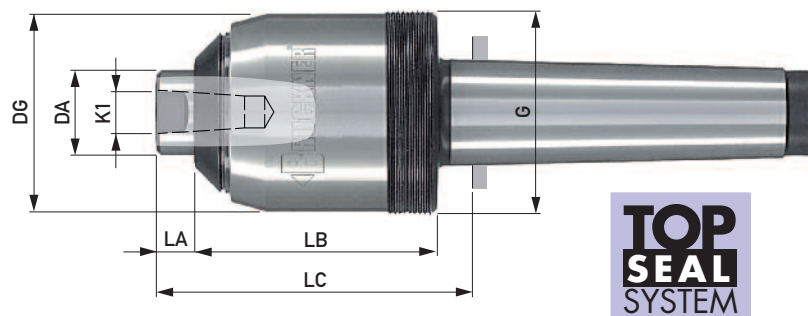

Type NCE	ID.No.	34.045-2	34.045-3	44.058-3	34.058-4	44.076-4	34.076-5	44.095-5	34.095-6
Draw-off nut	ID.No.	M45A	M45A	M60	M60	M80	M80	M100	M100
Morse taper		2	3	3	4	4	5	5	6
DA		20	20	25	25	35	35	45	45
DG		45	45	58	58	76	76	95	95
K1		11	11	15	15	22	22	28	28
LA		9	9	11	11	13	13	14	14
LB		57	57	70	70	81	81	103	103
LC		72	73	88	88	101	101	124	124
G		M 45x2	M 45x2	M 60x1,5	M 60x1,5	M 80x2	M 80x2	M 100x2	M 100x2
SW (spanner flat)		16	16	22	22	30	30	41	41
r.p.m. max.		8000	8000	7000	7000	6000	6000	5000	5000
Suitable insert (page 21)		482..	482..	484..	484..	487..	487..	485..	485..
Load	The load of type NCE is limited by the interchangeable inserts (page 21)								

The thread structure of the ID.Nos. 34.045-2 and 34.045-3 is similar to that of version A, fitting the special nut for version A (page 16).

BRUCKNER TOP-SEAL-SYSTEM

- The coolant does not impact the seal, but flows with reduced energy into the first labyrinth channel.
- There the largest part of the coolant is drained through the first drain aperture.
- The small residue is wiped off the seal into the second labyrinth channel and flows through the second drain aperture.

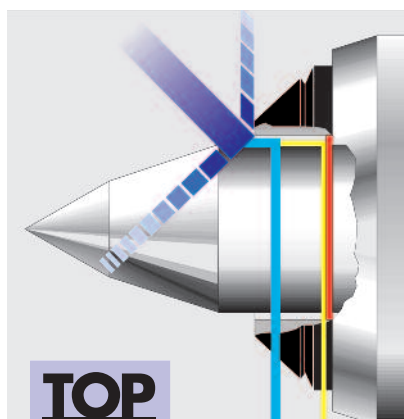

Interchangeable inserts

taper 1:7.5, in gauge accuracy

Form AO, 60°
draw-off thread

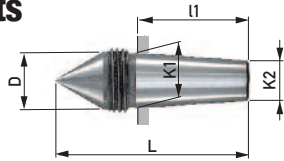

Form ASL, 60°
slim, extended
draw-off thread

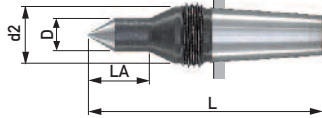

Form AKOP, 60°/40°
extended
draw-off thread

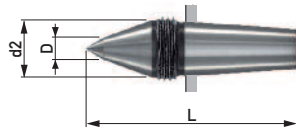

Form A, 60°
for hollow parts
spanner flat

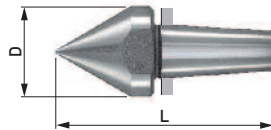

Form B, centre 60°
for centreless workpieces,
draw-off thread

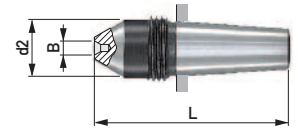

Form C, centre 60°
for centreless workpieces,
external angle 60° for hollow
parts, spanner flat

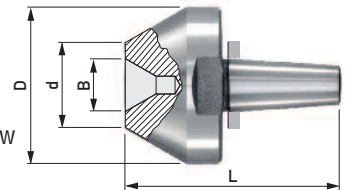

Form D, centre 60°
for centreless workpieces,
spanner flat

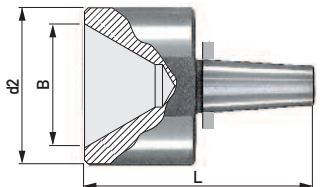

Form AOHM, 60°
with carbide insert
draw-off thread

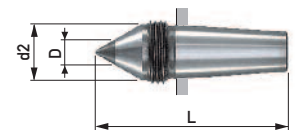

Basic centre Type: NCE	Interchangeable inserts	Radial load max. daN	Insert dimensions						Thread SW	Taper dimensions taper 1:7.5		
			D	d2	B	d	L	LA		K1	K2	I1
34.045-2 34.045-3	482AO	90	11.7				45		M 14x1.5	11	8	23
	482ASL	30	6	11.7			55	15	M 14x1.5			
	482AKOP	90	5	11.7			50		M 14x1.5			
	482A	90	17				45		SW14			
	482B	90		11.7	4x2		45		M 14x1.5			
	482C	90	28		8x3	12	45		SW24			
	482D	90		28	20x6		45		SW24			
	482AOHM	60	7	11.7			45		M 14x1.5			
44.058-3 34.058-4	484AO	160	15.7				53		M 18x1.5	15	11	30
	484ASL	100	9	15.7			65	17	M 18x1.5			
	484AKOP	160	6	15.7			58		M 18x1.5			
	484A	160	25				60		SW22			
	484B	110		15.7	4x2		53		M 18x1.5			
	484C	160	44		15x5	24	60		SW41			
	484D	160		44	35x12		64		SW41			
	484AOHM	60	7	15.7			53		M 18x1.5			
44.076-4 34.076-5	487AO	300	21.6				74		M 24x1.5	22	16.4	42
	487ASL	100	9	21.6			86	17	M 24x1.5			
	487AKOP	300	8	21.6			80		M 24x1.5			
	487A	300	32				82		SW27			
	487B	240		21.6	5x2,5		74		M 24x1.5			
	487C	300	55		20x6	30	82		SW50			
	487D	300		55	45x15		85		SW50			
	487AOHM	200	11	21.6			74		M 24x1.5			
44.095-5 34.095-6	485AO	500	27.7				93		M 30x1.5	28	21	52.5
	485ASL	180	13	27.7			110	27	M 30x1.5			
	485AKOP	500	8	27.7			105		M 30x1.5			
	485A	500	45				105		SW41			
	485B	500		27.7	7x3		93		M 30x1.5			
	485C	500	65		25x6	35	105		SW55			
	485D	500		65	55x20		105		SW55			
	485AOHM	500	18	27.7			93		M 30x1.5			

ID.No.	Content
P 10	100 g

Installation paste

Makes insert change easier.
Apply thinly and evenly to the insert taper.

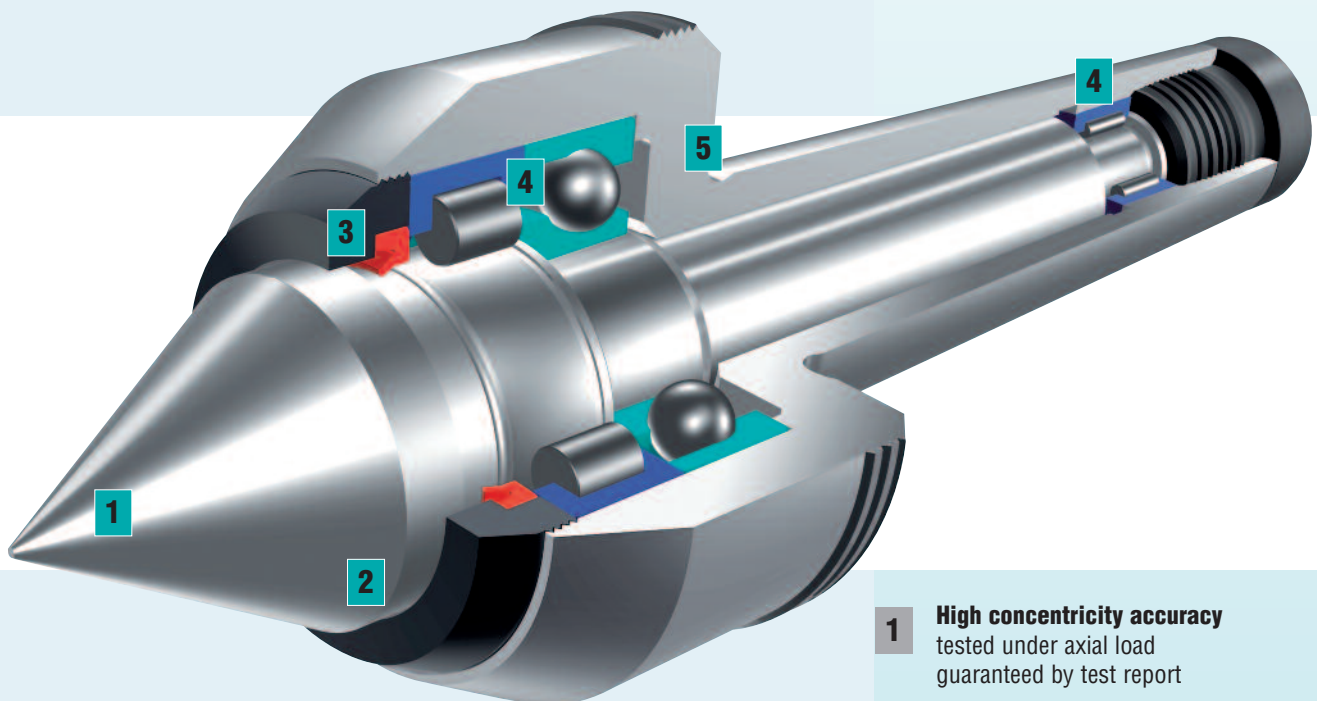

LK Series – with superior stiffness

This high performance live centre was developed for use with advanced turning and grinding technology. With a short design, the bearings and pitch of the bearings distance are matched so that this high performance centre withstands vibrations in all machining situations. The bearings are designed for higher r.p.m.

Result

- ▶ Excellent surface quality
- ▶ Longer tool life
- ▶ Improved machine tool efficiency

Two types for MT4 and MT5

- ▶ Slim design for light machining
- ▶ With stronger bearings for normal to heavy machining

- 1 High concentricity accuracy**
tested under axial load
guaranteed by test report
- 2 Through-hardened alloy tool steel centrepoint**
- 3 Seal ring**
protects the bearings from dirt and coolant
- 4 Precision bearings**
bearings seats of housing and centre spindle are precision ground and matched to the bearings. Maintenance-free due to permanent lubrication
- 5 Housing**
of high tensile alloy tool steel. Housing head and shank are case-hardened for protection against damage

Types LKS, LKSG

Centrepoint 60°

Runout

Type LKS max. 0.005 mm

Type LKSG max. 0.003 mm

with test report

Application

High performance turning, hard turning, fine turning, cylindrical grinding.

Optimum workpiece surface finish due to the short stable anti-vibration design.

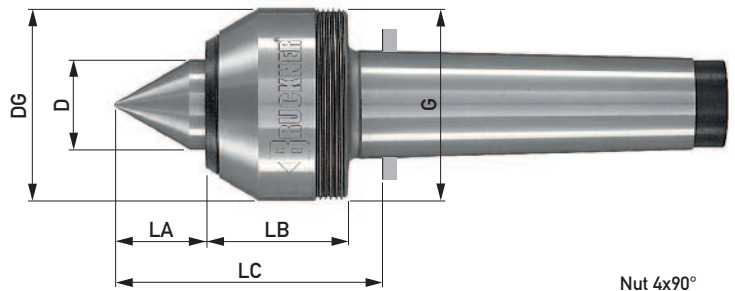

Draw-off nut			
ID.No.	G	LM	DM
M55L	M55x1.5	10	68
M68L(MT4)	M68x1.5	15	80
M68L-5 (MT5)	M68x1.5	15	80
M92L	M92x1.5	18	110
M127L	M127x1.5	18	145

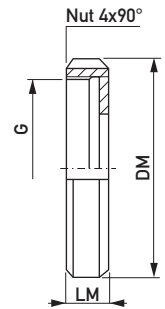

Type LKS	ID.No.	750S 055003A	750S 055004A	750S 068004A	750S 068005A	750S 092005A	750S 127006A
Type LKSG	ID.No.	751S 055003A	751S 055004A	751S 068004A	751S 068005A	751S 092005A	751S 127006A
Morse taper		3	4	4	5	5	6
D		26	26	36	36	51	71
DG		55	55	68	68	92	127
LA		26	26	35	35	47	65
LB		41	41	51,5	51,5	60	80
LC		71	72	92	92	113	152
G		M55x1.5	M55x1.5	M68x1.5	M68x1.5	M92x1.5	M127x1.5
Workpiece weight max. daN*		420	420	1200	1200	2000	4400
r.p.m. max. *		7000	7000	6000	6000	5000	3000
Radial/axial load graph		RL1/AL1	RL1/AL1	RL2/AL2	RL2/AL2	RL3/AL3	RL4/AL4
Draw-off nut		M55L	M55L	M68L	M68L-5	M92L	M127L

*observe the load graphs

Radial and axial loads for a bearing life of 2000 operating hours (calculation example on page 11)

Radial – Types LKS/LKSG

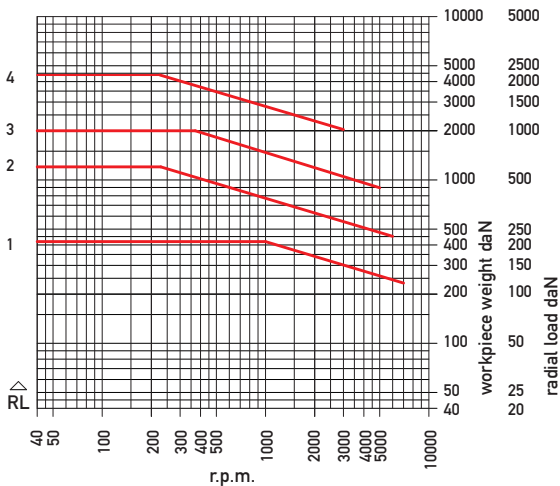

Axial – Types LKS/LKSG

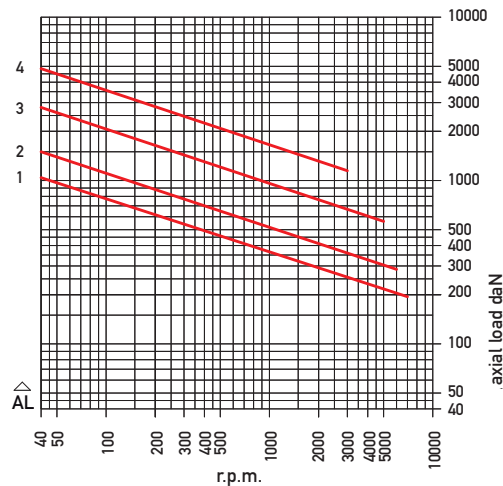

Types LKV, LKVG

Centrepoint 60°/40° extended

Runout

Type LKV max. 0.005 mm

Type LKVG max. 0.003 mm

with test report

Application

High performance turning, hard turning, fine turning, cylindrical grinding. The working space is enlarged due to the extended, slim centrepoint.

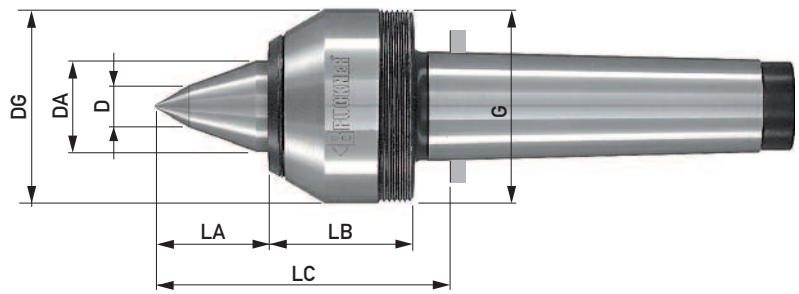

Type LKV	ID.No.	750V 055003A	750V 055004A	750V 068004A	750V 068005A	750V 092005A
Type LKVG	ID.No.	751V 055003A	751V 055004A	751V 068004A	751V 068005A	751V 092005A
Morse taper		3	4	4	5	5
DA		26	26	36	36	51
D		12	12	14	14	17
DG		55	55	68	68	92
LA		33	33	45,5	45,5	64
LB		41	41	51,5	51,5	60
LC		78	79	102	103	130
G		M55x1.5	M55x1.5	M68x1.5	M68x1.5	M92x1.5
Workpiece weight max. daN*		320	320	900	900	1400
r.p.m. max.*		7000	7000	6000	6000	5000
Radial/axial load graph		RD1/AD1	RD1/AD1	RD2/AD2	RD2/AD2	RD3/AD3
Draw-off nut (page 23)		M55L	M55L	M68L	M68L-5	M92L

*observe the load graphs

Radial and axial loads for a bearing life of 2000 operating hours (calculation example on page 11)

Radial – Types LKV/LKVG

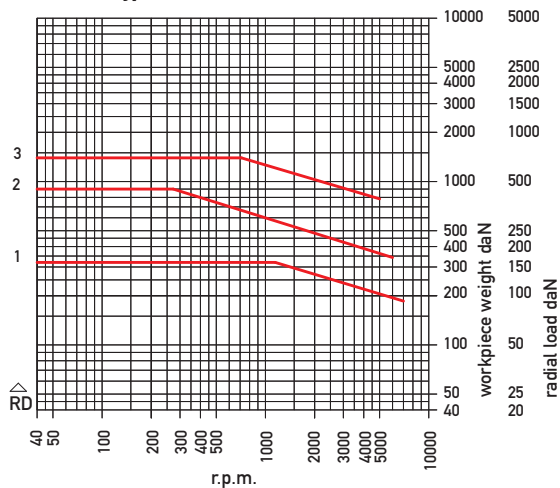

Axial – Types LKV/LKVG

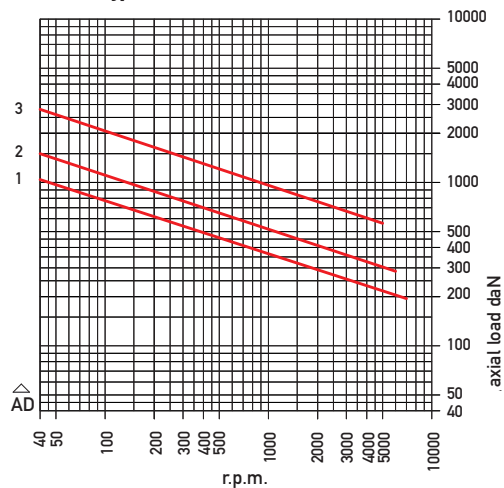

Types LKH, LKHG

Centrepoint 60° with carbide insert

Runout

Type LKH max. 0.005 mm

Type LKHG max. 0.003 mm

with test report

Application

High performance turning, hard turning, fine turning, cylindrical grinding.
For operations in which additional stress is put on the centrepoint (e.g. large series, workpiece change when spindle is running, hard workpieces, extremely small workpiece centres).

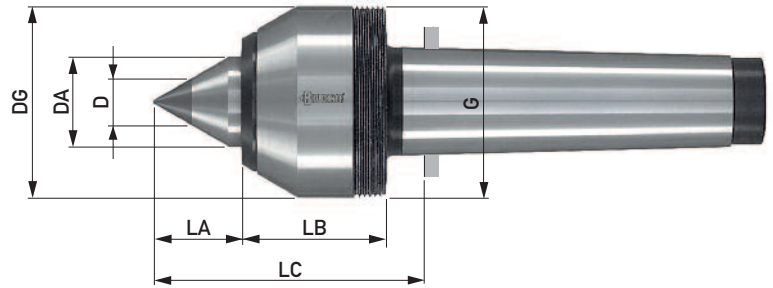

Type LKH	ID.No.	750H 055003A	750H 055004A	750H 068004A	750H 068005A	750H 092005A
Type LKHG	ID.No.	751H 055003A	751H 055004A	751H 068004A	751H 068005A	751H 092005A
Morse taper		3	4	4	5	5
DA		26	26	36	36	51
D		14	14	18	18	18
DG		55	55	68	68	92
LA		26	26	35	35	47
LB		41	41	51,5	51,5	60
LC		71	72	92	92	113
G		M55x1.5	M55x1.5	M68x1.5	M68x1.5	M92x1.5
Workpiece weight max. daN*		240	240	450	450	500
r.p.m. max.*		7000	7000	6000	6000	5000
Radial/axial load graph		RE1/AE1	RE1/AE1	RE2/AE2	RE2/AE2	RE3/AE3
Draw-off nut (page 23)		M55L	M55L	M68L	M68L-5	M92L

*observe the load graphs

Radial and axial loads for a bearing life of 2000 operating hours (calculation example on page 11)

Radial – Types LKH/LKHG

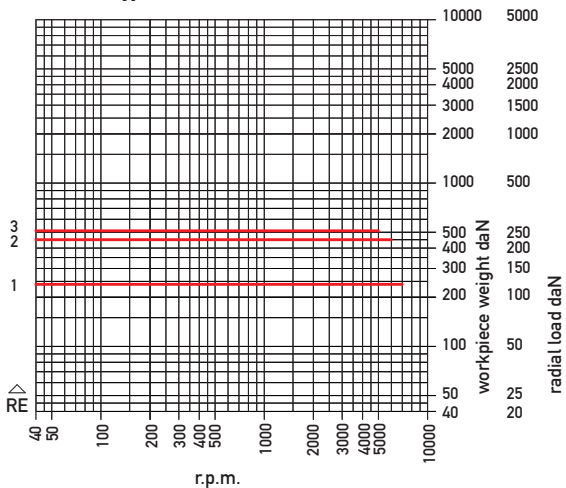

Axial – Types LKH/LKHG

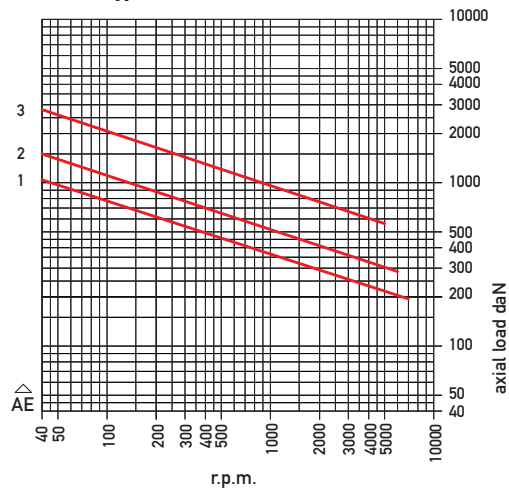

Type 2000

Centrepoint 60°

Runout

max. 0.005 mm

Hardened housing, through-hardened alloy tool steel centrepoint. Sealed with seal ring.

Maintenance-free due to permanent lubrication.

Application

For normal to high-duty work.

For all turning operations, roughing, finishing and CNC turning.

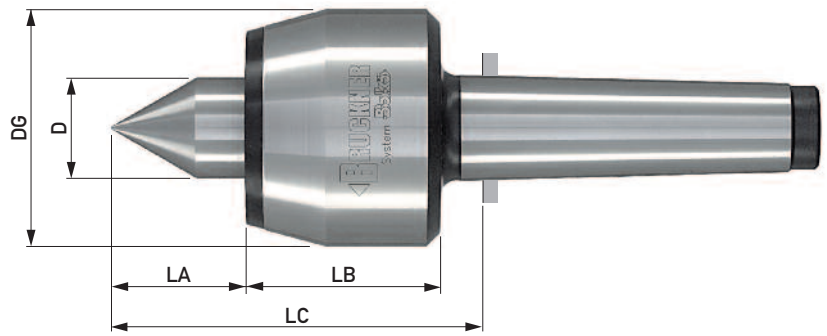

Type 2000	ID.No.	2.003	2.004	2.005
Morse taper		3	4	5
D		24	30	35
DG		55	70	85
LA		31	40	47
LB		45	57	67
LC		83	106	125
Workpiece weight max. daN*		400	700	1240
r.p.m. max.*		4000	3200	2500
Radial/axial load graph		RB1/AB1	RB2/AB2	RB3/AB3

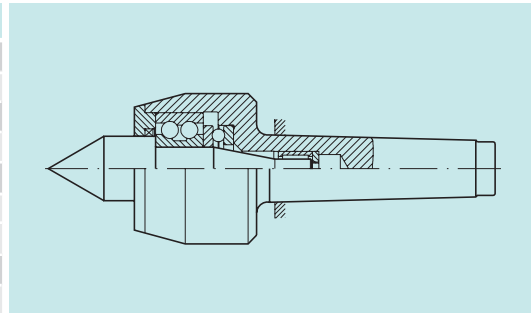

*observe the load graphs

Radial and axial loads for a bearing life of 2000 operating hours (calculation example on page 11)

Radial - Type 2000

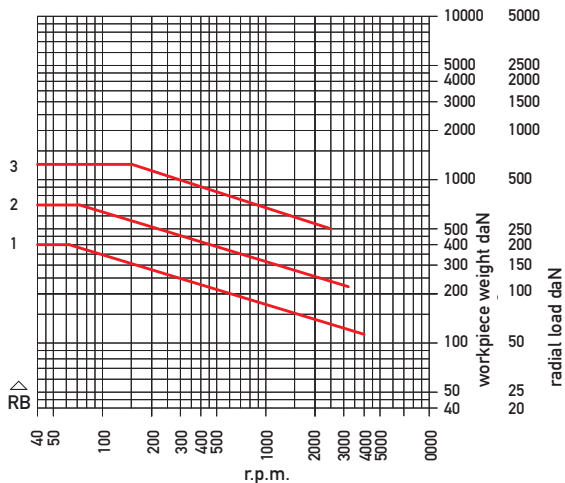

Axial - Type 2000

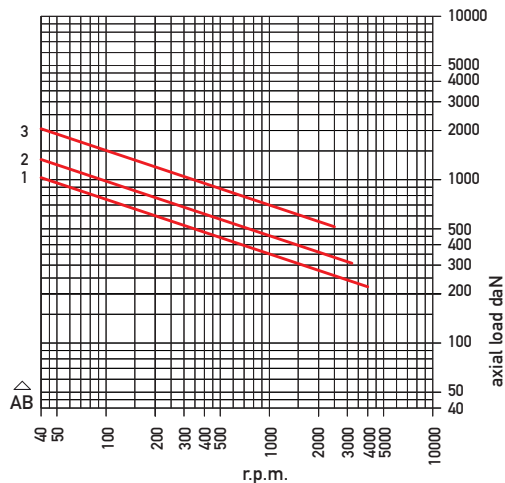

Type 2030

Centrepoint 60°/30° extended

Runout

max. 0.005 mm

Hardened housing, through-hardened alloy tool steel centrepoint. Sealed construction. Maintenance-free due to permanent lubrication.

Application

Use when the workspace between live centre and workpiece end is confined. The extended slim centrepoint allows improved access for cutting tools.

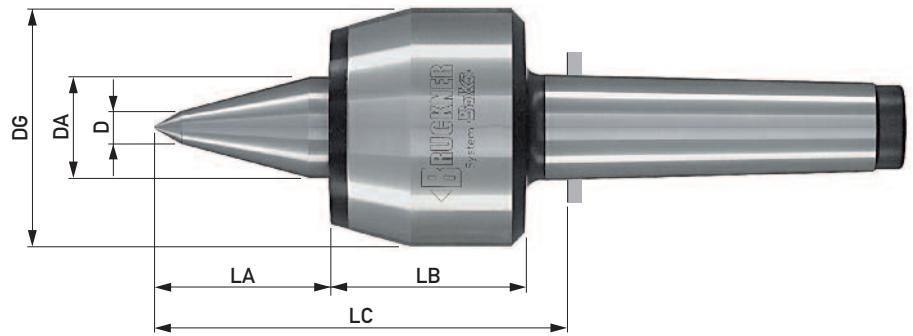

Type 2030	ID.No.	2.033	2.034	2.035
Morse taper		3	4	5
DA		24	30	35
D		8	10	12
DG		55	70	85
LA		42	52	58
LB		45	57	67
LC		94	118	136
Workpiece weight max. daN*		200	400	800
r.p.m. max.*		4000	3200	2500
Radial/axial load graph		R01/A01	R02/A02	R03/A03

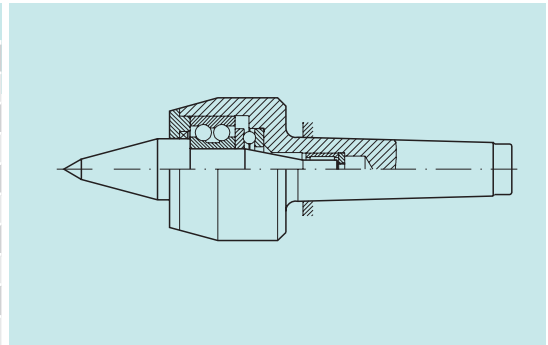

*observe the load graphs

Radial and axial loads for a bearing life of 2000 operating hours (calculation example on page 11)

Radial – Type 2030

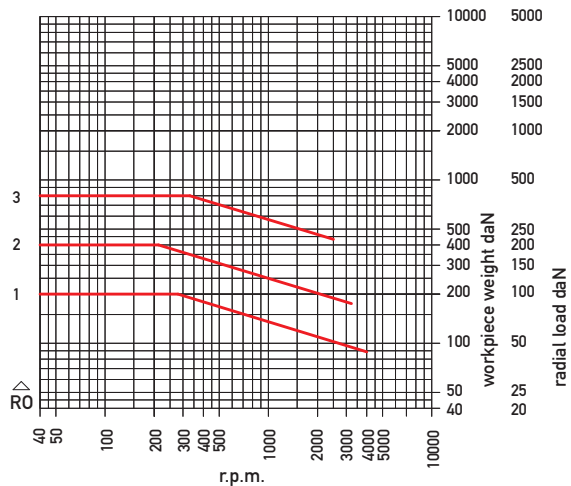

Axial – Type 2030

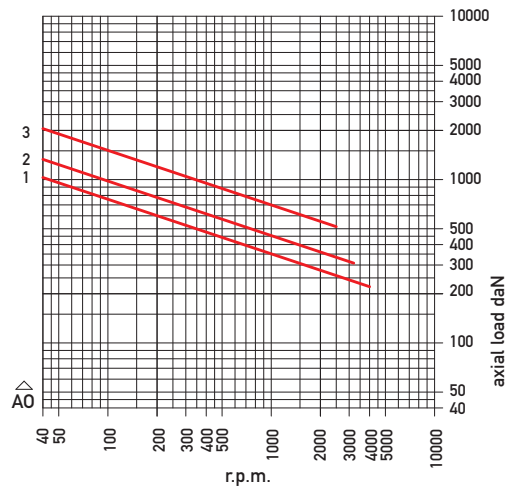

Technical features LR/LD series

LR series

spring loaded centrepont, pressure indication by yellow, green and red rings

LD series

spring loaded centrepont, for expansion compensation, without pressure indication

axial force per coloured ring

Morse taper	axial force daN		
3	0 - 250	250 - 500	500 - 850
4	0 - 350	350 - 620	620 - 850
5	0 - 570	570 - 1000	1000 - 1360
6	0 - 1700	1700 - 3200	3200 - 4600

Reduction of spring force through soft spring on request

example of function for design line LR

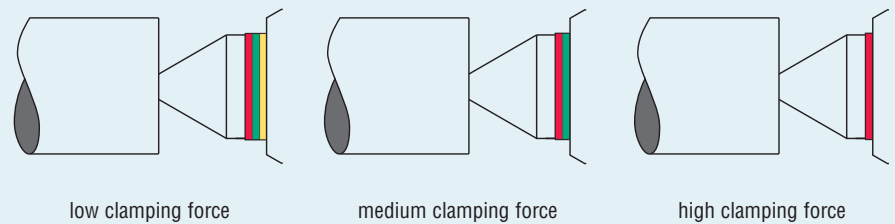

The yellow, green and red ranges of axial forces are permanently laser marked on the heads of the centre housings.

Example type LRS, 700S 068004

Yellow	0-350 daN
Green	350-620 daN
Red	620-850 daN



Design A with draw-off thread and draw-off nut

All sizes of LR and LD are available with draw-off thread. Simply add a capital **A** to the ID.No.

Order example for type LRS MT4:
ID.No.: 700S 068004**A**

Draw-off nut				
ID.No.	for centre with housing diameter \varnothing	LM	DM	G
M45L	45	9	55	M 45x1.5
M55L	55	10	68	M 55x1.5
M68L	68	15	80	M 68x1.5
M92L	92	18	110	M 92x1.5
M127L	127	18	145	M 127x1.5

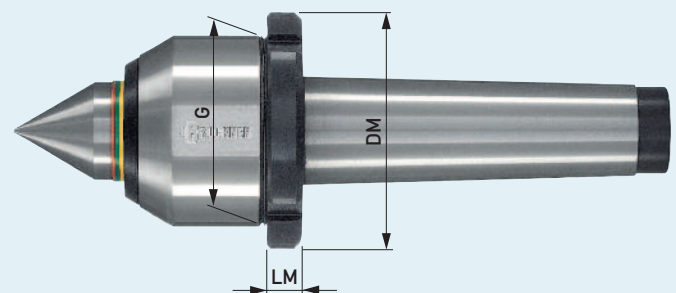

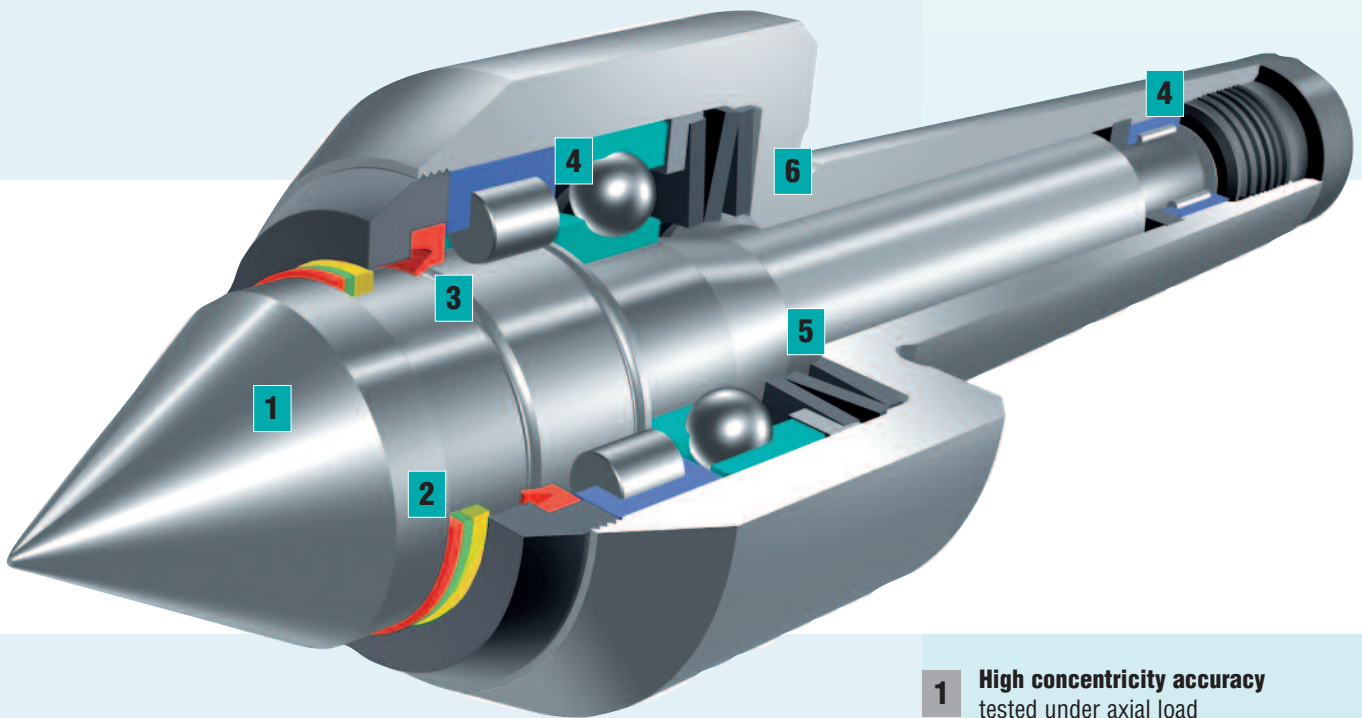

LR Series – simultaneous clamping and regulation

The spring loaded centrepoint with coloured rings for pressure indication allows simple adjustment and reading of the axial pressure. The spring loading compensates for workpiece thermal expansion and variation of workpiece length. LR series centres are essential for operations using face drivers or machine tools without pressure indication. The ideal arrangement of the high precision roller bearings prove the strength of the LR types for higher speed.

- 1 High concentricity accuracy**
tested under axial load
guaranteed by test report
- 2 Spring loaded centrepoint**
of through-hardened alloy wear
resistant tool steel. With coloured
rings for pressure indication
- 3 Seal ring**
protects the bearings from dirt and
coolant
- 4 Precision bearings**
with precision ground bearing seats
of housing and on the centre spindle.
The bearing seats are matched to the
bearings. Maintenance-free due to
permanent lubrication
- 5 Spring loading**
- 6 Housing**
of high tensile tool steel.
Housing head and shank are case
hardened for protection against
damage

Produced according to BRUCKNER WORKS STANDARD (page 8)

Types LRS, LRS G

Centrepoint 60° spring loaded
Pressure indication by coloured rings

Runout

Type LRS max. 0.005 mm
Type LRS G max. 0.003 mm
with test report

Application

Turning, CNC turning with multi-spindle machines or CNC lathes with twin tool turrets.
As a tailstock centre when using face drivers

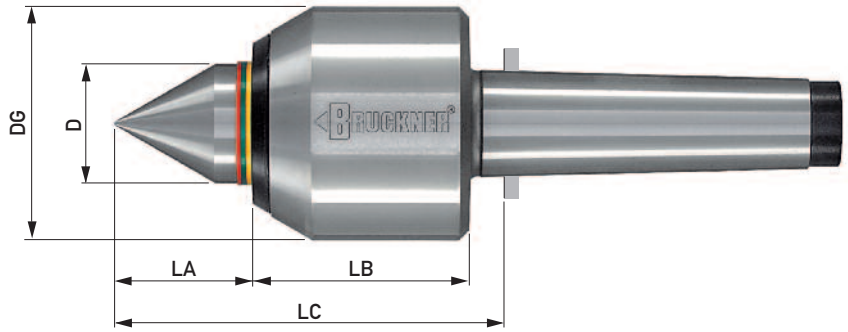

Type LRS	ID.No.	700S 055003	700S 068004	700S 092005	700S 127006
Type LRS G	ID.No.	701S 055003	701S 068004	701S 092005	701S 127006
Morse taper		3	4	5	6
D		25	35	50	70
DG		55	68	92	127
LA		28	40	57	74
LB		51	63	82	109
LC		84	108	145	190
Max. workpiece weight max daN*		420	1200	2000	4400
Spring travel		2.7	4.2	5.4	8.4
r.p.m. max.*		5000	4000	3500	2300
Radial/axial load graph		RR1/AR1	RR2/AR2	RR3/AR3	RR4/AR4
Axial force per coloured ring		page 28			

Available with draw-off thread and draw-off nut (design A, page 28)

*observe the load graphs

Radial and axial loads for a bearing life of 2000 operating hours (calculation example on page 11)

Radial – Types LRS, LRS G

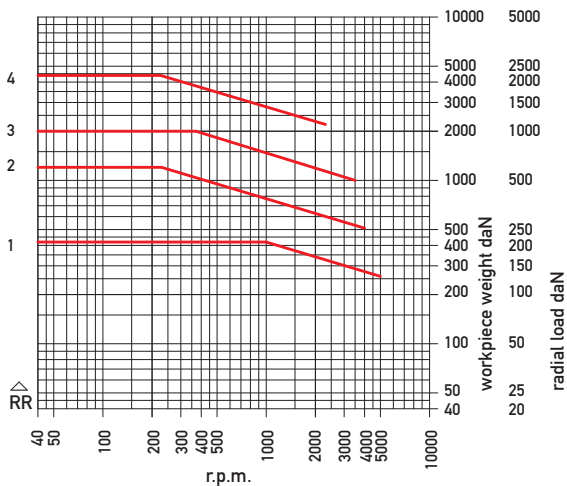

Axial – Types LRS, LRS G

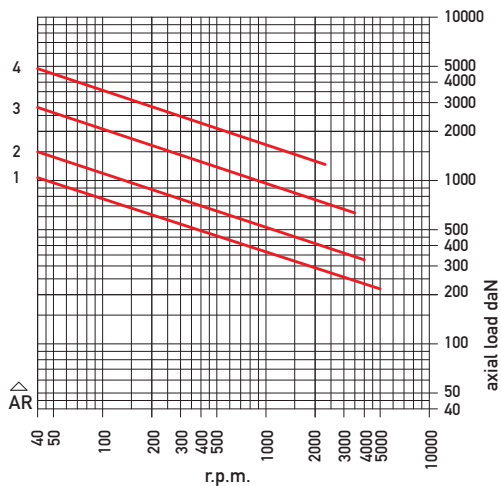

Type LRV

Centrepoint 60°/40° extended spring loaded with pressure indication by coloured rings

Runout

max. 0.005 mm with test report
max. 0.003 mm high precision design on request

Application

Turning, CNC turning.
With multi-spindle machines or CNC lathes with twin tool turrets.
As a tailstock centre when using face drivers. The extended slim centrepoint allows improved access for cutting tools

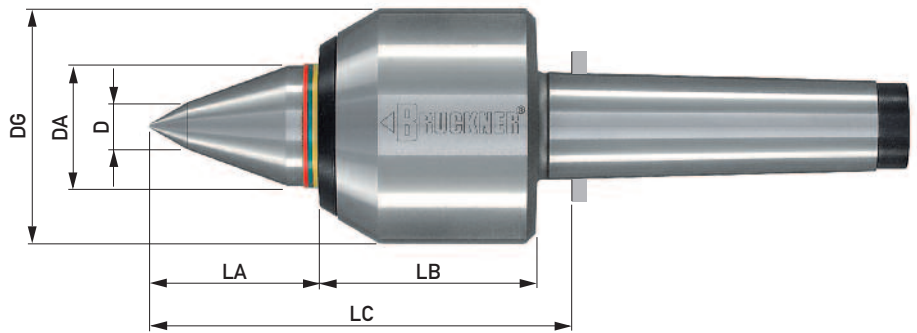

Type LRV	ID.No.	700V 055003	700V 068004	700V 092005
Morse taper		3	4	5
DA		25	35	50
D		12	14	18
DG		55	68	92
LA		37	49	69
LB		51	63	82
LC		93	117	157
Workpiece weight max. daN*		320	900	1400
Spring travel		2.7	4.2	5.4
r.p.m. max.*		5000	4000	3500
Radial/axial load graph		RF1/AF1	RF2/AF2	RF3/AF3
Axial force per coloured ring		page 28		

Available with draw-off thread and draw-off nut (design A, page 28)

*observe the load graphs

Radial and axial loads for a bearing life of 2000 operating hours (calculation example on page 11)

Radial – Type LRV

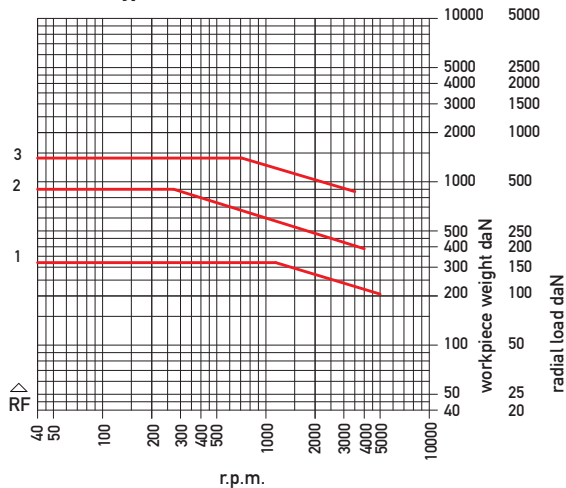

Axial – Type LRV

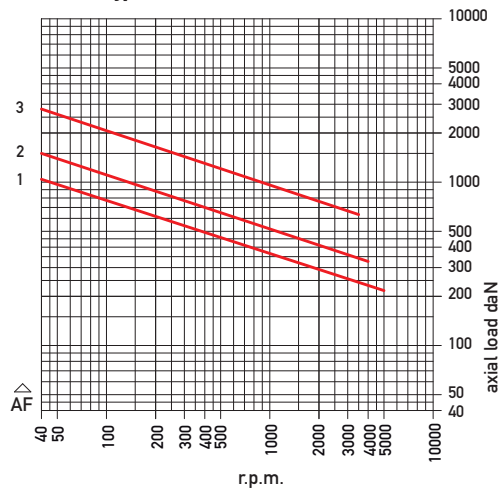

Type LRE

Spring loaded centre spindle with 1:7.5 internal taper for interchangeable inserts.
Pressure indication by coloured rings

Runout

max. 0.005 mm with test report
 max. 0.003 mm high precision design on request

Application

Turning, CNC turning with multi-spindle machines or CNC lathes with twin tool turrets.
 As a tailstock centre when using face drivers.

Advantages

As the centrepoint wears only the insert has to be changed and once again the high performance centre is ready for use. Flexibility in application is made possible by a choice of eight different insert styles (page 33).

Depending on the style the insert can be removed by its draw-off thread and draw-off nut or with spanners applied to the spanner flats.

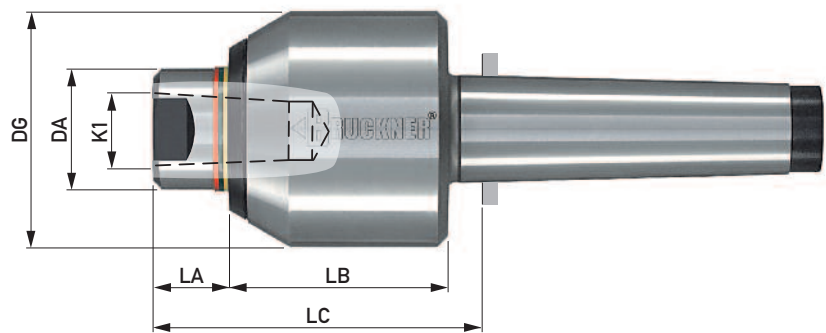

Type LRE	ID.No.	700E 055003	700E 068004	700E 092005
Morse taper		3	4	5
DA		25	35	50
K1		15	22	28
DG		55	68	92
LA		15	21	28
LB		51	63	82
LC		71	89	116
Spring travel		2.7	4.2	5.4
r.p.m. max.		5000	4000	3500
Suitable inserts		484..	487..	485..
Load	The radial load of type LRE is restricted by the interchangeable inserts (page 33)			
Axial force per coloured ring	page 28			

Available with draw-off thread and draw-off nut (design A, page 28)
 MT2 on request (700E 045002)

Interchangeable inserts

taper 1:7.5, in gauge accuracy

Form AO, 60°
draw-off thread

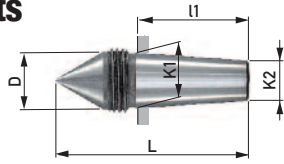

Form ASL, 60°
slim, extended
draw-off thread

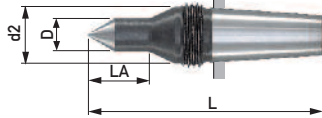

Form AKOP, 60°/40°
extended
draw-off thread

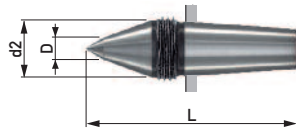

Form A, 60°
for hollow parts
spanner flat (SW)

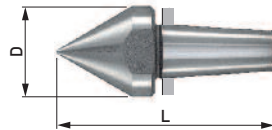

Form B, centre 60°
for centreless workpieces,
draw-off thread

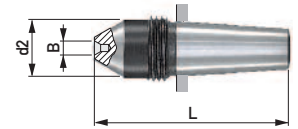

Form C, centre 60°
for centreless workpieces,
external angle 60° for hollow
parts, spanner flat (SW)

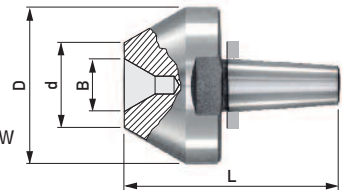

Form D, centre 60°
for centreless workpieces,
spanner flat (SW)

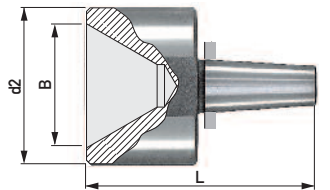

Form AOHM, 60°
with carbide insert
draw-off thread

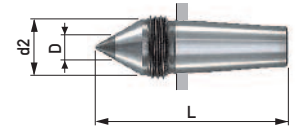

Basic body Type: LRE	Interchangeable inserts	Radial load max. daN	Insert dimensions						Thread SW	Taper dimensions		
			D	d2	B	d	L	LA		taper 1:7.5		
ID.No	ID.No								K1	K2	I1	
700E 055003	484AO	160	15.7					53		15	11	30
	484ASL	100	9	15.7				65	17			
	484AKOP	160	6	15.7				58				
	484A	160	25					60				
	484B	110		15.7	4x2			53				
	484C	160	44		15x5	24		60				
	484D	160		44	35x12			64				
	484AOHM	60	7	15.7				53				
700E 068004	487AO	300	21.6					74		22	16.4	42
	487ASL	100	9	21.6				86	17			
	487AKOP	300	8	21.6				80				
	487A	300	32					82				
	487B	240		21.6	5x2,5			74				
	487C	300	55		20x6	30		82				
	487D	300		55	45x15			85				
	487AOHM	200	11	21.6				74				
700E 092005	485AO	500	27.7					93		28	21	52.5
	485ASL	180	13	27.7				110	27			
	485AKOP	500	8	27.7				105				
	485A	500	45					105				
	485B	500		27.7	7x3			93				
	485C	500	65		25x6	35		105				
	485D	500		65	55x20			105				
	485AOHM	500	18	27.7				93				

ID.No.	Content
P 10	100 g

Installation paste

Makes insert change easier.
Apply thinly and evenly to the insert taper.

Type LDS

Centrepoint 60°
Spring loaded for expansion compensation,
without pressure indication

Runout

max. 0.005 mm, with test report
 max. 0.003 mm high precision design on request

Application

Turning, CNC turning, precision design for cylindrical grinding and measuring

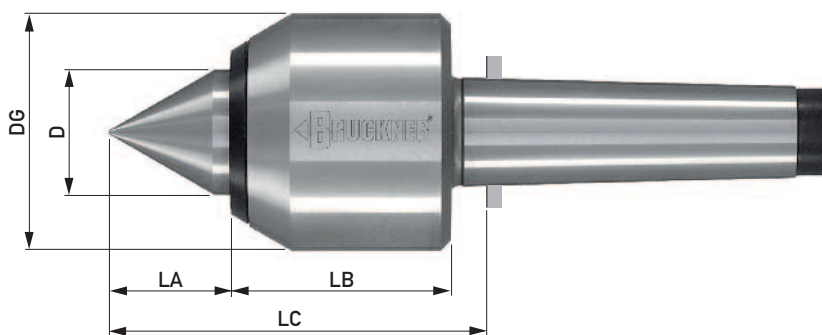

Type LDS	ID.No.	710S 045002	710S 055003	710S 068004	710S 092005	710S 127006
Morse taper		2	3	4	5	6
D		19	26	36	51	71
DG		45	55	68	92	127
LA		24	26	35	47	65
LB		45	51	63	82	109
LC		72	82	103	135	181
Workpiece weight max. daN*		320	420	1200	2000	4400
Spring travel		0.85	0.95	1.4	1.8	2.8
r.p.m. max.*		5500	5000	4000	3500	2300
Radial/axial load graph		RS1/AS1	RS2/AS2	RS3/AS3	RS4/AS4	RS5/AS5

Available with draw-off thread and draw-off nut (design A, page 28)

*observe the load graphs

Radial and axial loads for a bearing life of 2000 operating hours (see calculation example on page 11)

Radial – Type LDS

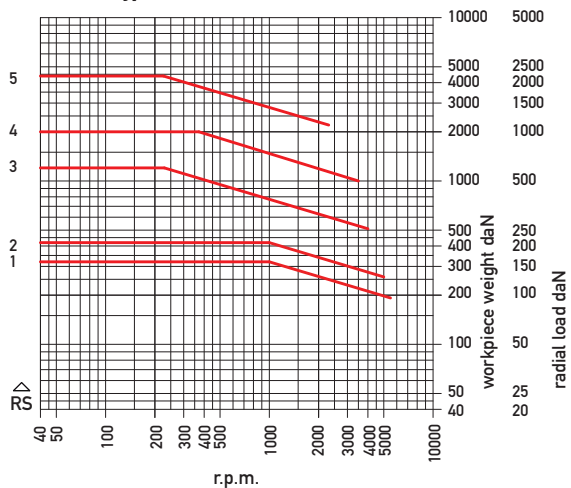

Axial – Type LDS

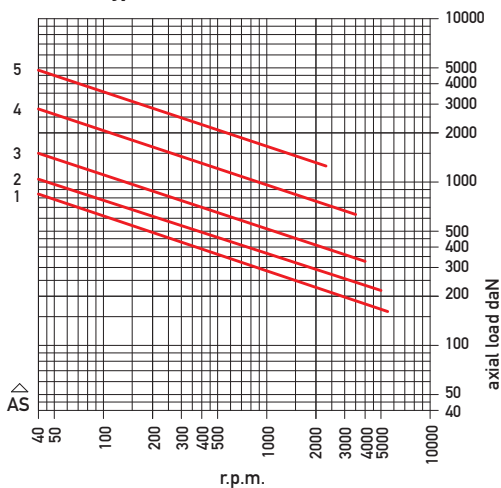

Type LDA

Centre spindle with 1:5 external taper for interchangeable tapered caps.
Spring loaded for expansion compensation, without pressure indication

Runout

max. 0.005 mm, with test report

Application

Workpieces with large bores.
 Retaining and extraction screws are included with these centres.

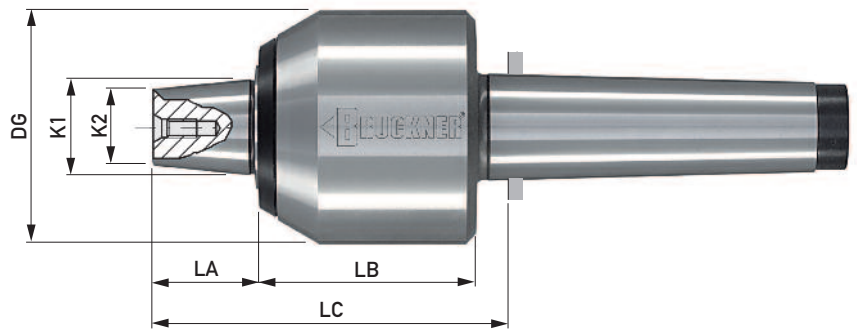

Type LDA	ID.No.	710A 045002	710A 055003	710A 068004	710A 092005	710A 127006
Morse taper		2	3	4	5	6
K1		18	23	28	38	48
K2		14.3	18.4	22.3	30.4	37.6
DG		45	55	68	92	127
LA		22	26	31	42	58
LB		45	51	63	82	109
LC		70	82	99	129	173
Workpiece weight max. daN*		280	320	900	1400	3600
Spring travel		0.85	0.95	1.4	1.8	2.8
r.p.m. max.*		5500	5000	4000	3500	2300
Radial/axial load graph		RA1/AA1	RA2/AA2	RA3/AA3	RA4/AA4	RA5/AA5

Available with draw-off thread and draw-off nut (design A, page 28)

*observe the load graphs

Basic body Type LDA ID.No.	Tapered cap KA internal taper 1:5 through hardened alloy tool steel				
	ID.No.	D	d	K1	L
710A 045002	7KA2.056	56	15	18	44
710A 055003	7KA3.068	68	18	23	51
	7KA3.110	110	60	23	53
710A 068004	7KA4.080	80	20	28	60
	7KA4.130	130	70	28	62
710A 092005	7KA5.110	110	30	38	80
	7KA5.175	175	95	38	80
710A 127006	7KA6.150	150	45	48	101
	7KA6.225	225	120	48	101

Special dimensions on request

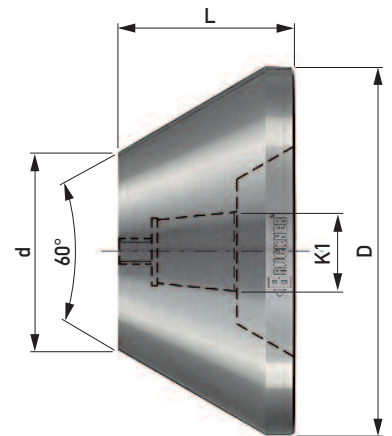

Radial and axial loads for a bearing life of 2000 working hours (see calculation example page 11)

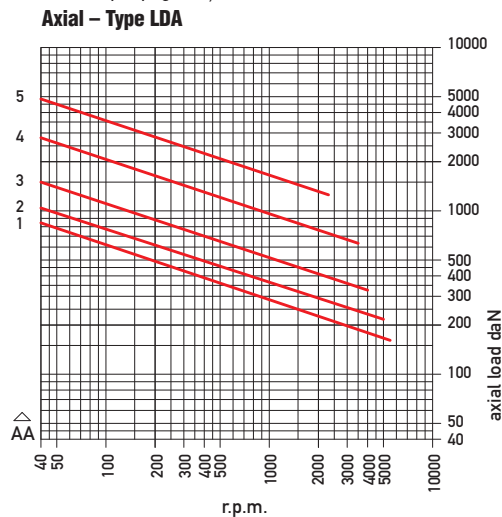
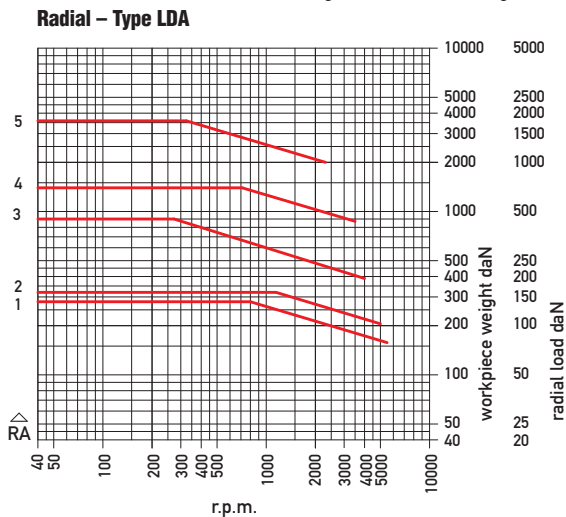

Type LDE

Centre spindle with 1:7.5 internal taper for interchangeable inserts. Spring loaded for expansion compensation, without pressure indication

Runout

max. 0.005 mm, with test report
max. 0.003 mm high precision design on request

Application

Turning, CNC turning

Advantages

As the centrepoint wears only the insert has to be changed and once again the high performance centre is ready for use. Flexibility in application is made possible by a choice of eight different insert styles (page 37). Depending on the style the insert can be removed by its draw-off thread and draw-off nut or with spanners applied to the spanner flats.

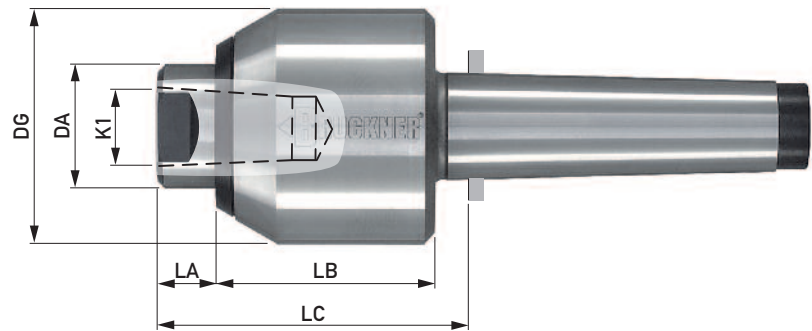

Type LDE	ID.No.	710E 045002	710E 055003	710E 068004	710E 092005
Morse taper		2	3	4	5
DA		19	26	36	51
K1		11	15	22	28
DG		45	55	68	92
LA		9	14	18	20
LB		45	51	63	82
LC		57	70	86	107
Spring travel		0.85	0.95	1.4	1.8
r.p.m. max.		5500	5000	4000	3500
Suitable inserts		482..	484..	487..	485..
Load	The radial load of type LDE is restricted by the interchangeable inserts (page 37)				

Available with draw-off thread and draw-off nut (design A, page 28)

Interchangeable inserts

taper 1:7.5, in gauge accuracy

Form AO, 60°
draw-off thread

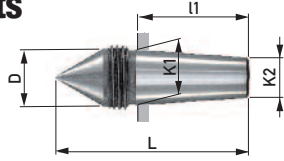

Form ASL, 60°
slim, extended
draw-off thread

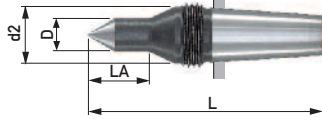

Form AKOP, 60°/40°
extended
draw-off thread

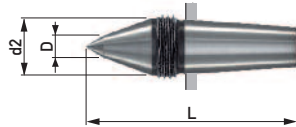

Form A, 60°
for hollow parts
spanner flat (SW)

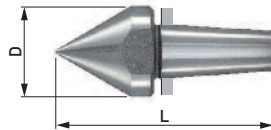

Form B, centre 60°
for centreless workpieces,
draw-off thread

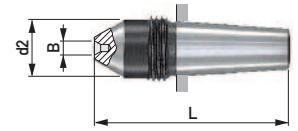

Form C, centre 60°
for centreless workpieces,
external angle 60° for hollow
parts, spanner flat (SW)

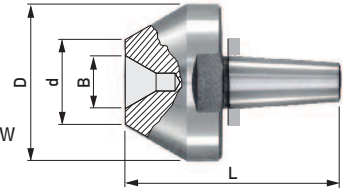

Form D, centre 60°
for centreless workpieces,
spanner flat (SW)

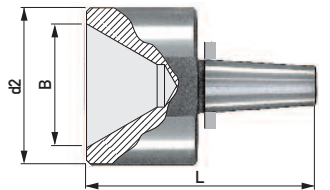

Form AOHM, 60°
with carbide insert
draw-off thread

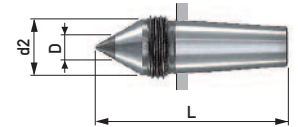

Basic Centre Types: LDE, TRE	Interchangeable Inserts	Radial load max. daN	Insert dimensions						Thread SW	Taper dimensions taper 1:7.5		
			D	d2	B	d	L	LA		K1	K2	I1
710E 045002	482AO	90	11.7				45		M 14x1.5	11	8	23
	482ASL	30	6	11.7			55	15	M 14x1.5			
	482AKOP	90	5	11.7			50		M 14x1.5			
	482A	90	17				45		SW14			
	482B	90		11.7	4x2		45		M 14x1.5			
	482C	90	28		8x3	12	45		SW24			
	482D	90		28	20x6		45		SW24			
	482AOHM	60	7	11.7			45		M 14x1.5			
710E 055003	484AO	160	15.7				53		M 18x1.5	15	11	30
	484ASL	100	9	15.7			65	17	M 18x1.5			
	484AKOP	160	6	15.7			58		M 18x1.5			
	484A	160	25				60		SW22			
	484B	110		15.7	4x2		53		M 18x1.5			
	484C	160	44		15x5	24	60		SW41			
	484D	160		44	35x12		64		SW41			
	484AOHM	60	7	15.7			53		M 18x1.5			
710E 068004	487AO	300	21.6				74		M 24x1.5	22	16.4	42
	487ASL	100	9	21.6			86	17	M 24x1.5			
	487AKOP	300	8	21.6			80		M 24x1.5			
	487A	300	32				82		SW27			
	487B	240		21.6	5x2,5		74		M 24x1.5			
	487C	300	55		20x6	30	82		SW50			
	487D	300		55	45x15		85		SW50			
	487AOHM	200	11	21.6			74		M 24x1.5			
710E 092005	485AO	500	27.7				93		M 30x1.5	28	21	52.5
	485ASL	180	13	27.7			110	27	M 30x1.5			
	485AKOP	500	8	27.7			105		M 30x1.5			
	485A	500	45				105		SW41			
	485B	500		27.7	7x3		93		M 30x1.5			
	485C	500	65		25x6	35	105		SW55			
	485D	500		65	55x20		105		SW55			
	485AOHM	500	18	27.7			93		M 30x1.5			

ID.No.	Content
P 10	100 g

Installation paste

Makes insert change easier.
Apply thinly and evenly to the insert taper.



Technical features:

- ▶ Spring loaded centres with pressure indication by yellow, green, red rings.
- ▶ Designed for high radial and axial loads and for higher speeds.
- ▶ High precision bearings in the head of the housing and within the taper. The bearing seats of housing and centre spindle are matched to the bearings and ground to precise tolerances.
- ▶ High concentricity accuracy tested under axial load and guaranteed with test report.
- ▶ Housings and centre spindles are hardened.
- ▶ Rotary seals protect bearings from dirt and coolant.
- ▶ Maintenance-free due to permanent lubrication.

Applications:

- ▶ Multi-spindle machines
- ▶ CNC lathes without tailstock
- ▶ CNC lathes with opposed spindle

Design principle on page 29, type LR

Range of axial force per coloured ring

Housing Ø DG	axial force daN		
55	0-250	250-500	500-850
68	0-350	350-620	620-850

Reduction of spring force through soft spring on request

Example of function for T Line

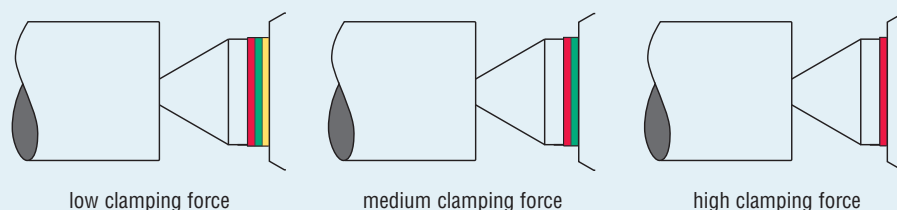

VDI shank

- Type TRS** – centrepoint 60°
- Type TRV** – centrepoint 60°/40° extended
- Type TRE** – centre spindle with 1:7.5 internal taper for interchangeable inserts (page 37)

Runout

max. 0.005 mm with test report
 max. 0.003 mm high precision design
 on request

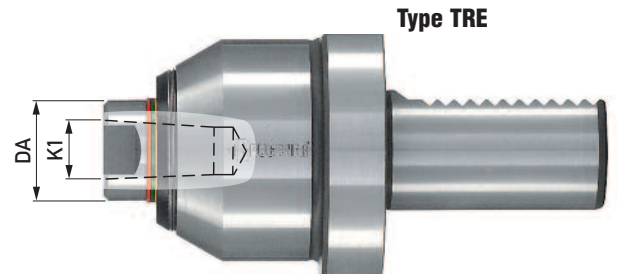
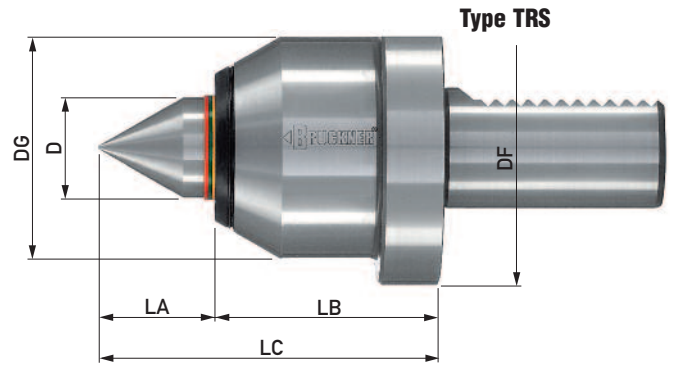

Interchangeable inserts for type TRE on page 37

Type	TRS	TRV	TRE	TRS	TRV	TRE
ID.No.	700S 055VDI30	700V 055VDI30	700E 055VDI30	700S 068VDI40	700V 068VDI40	700E 068VDI40
Shaft size VDI	30	30	30	40	40	40
DG	55	55	55	68	68	68
DA	-	25	25	-	35	35
D	25	12	-	35	14	-
DF	68	68	68	83	83	83
K1	-	-	15	-	-	22
LA	28	37	13	40	49	21
LB	56	56	56	68	68	68
LC	84	93	68,5	108	117	90
Workpiece weight max. daN*	420	320	*	800	700	*
Spring travel	2.7	2.7	2.7	4.2	4.2	4.2
r.p.m. max.*	5000	5000	5000	4000	4000	4000
Radial/axial load graph	RT2/AT1	RT1/AT1	*	RT4/AT2	RT3/AT2	*
Suitable inserts	-	-	484..	-	-	487..

*The radial load of type TRE is limited by the interchangeable inserts (page 37)

*observe the load graphs

Radial and axial loads for a bearing life of 2000 operating hours (see calculation example page 11)

Radial – Types TRS/TRV VDI

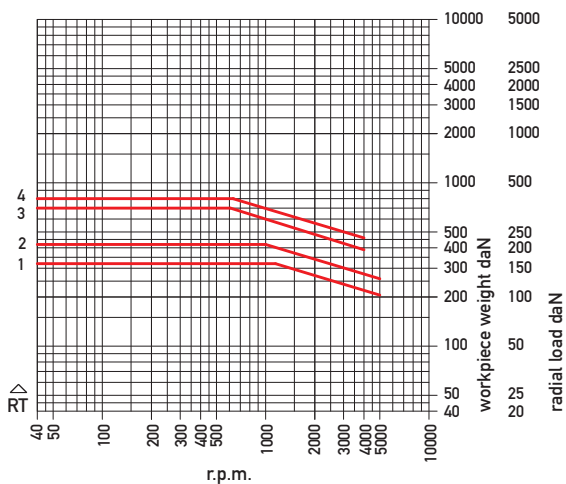

Axial – Types TRS/TRV VDI

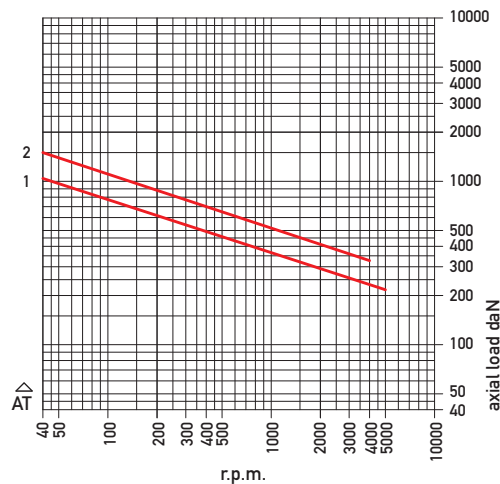

Capto shank

- Type TRS** – centrepoint 60°
- Type TRV** – centrepoint 60°/40° extended
- Type TRE** – centre spindle with 1:7.5 internal taper for interchangeable inserts (page 37)

Runout

max. 0.005 mm with test report
 max. 0.003 mm high precision design on request

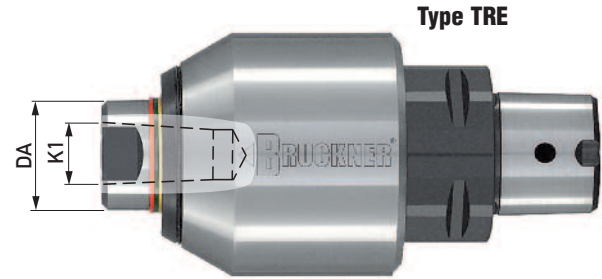
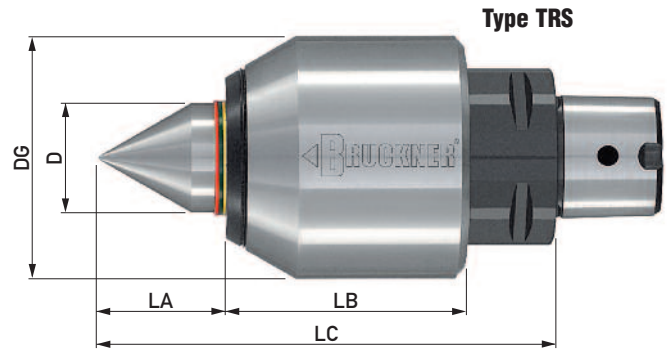

Interchangeable inserts for type TRE on page 37

Type	TRS	TRV	TRE	TRS	TRE	TRS	TRE
ID.No.	700S 055C04	700V 055C04	700E 055C04	700S 068C05	700E 068C05	700S 068C06	700E 068C06
Shaft size Capto	C4	C4	C4	C5	C5	C6	C6
DG	55	55	55	68	68	68	68
DA	-	25	25	-	35	-	35
D	25	12	-	35	-	35	-
K1	-	-	15	-	22	-	22
LA	28	37	13	40	21	40	21
LB	54	54	54	74	74	76	76
LC	103	112	87	134	116	138	120
Workpiece weight max. daN*	420	320	*	800	*	800	*
Spring travel	2.7	2.7	2.7	4.2	4.2	4.2	4.2
r.p.m. max.*	5000	5000	5000	4000	4000	4000	4000
Radial/axial load graph	RT2/AT1	RT1/AT1	*	RT4/AT2	*	RT4/AT2	*
Suitable inserts	-	-	484..	-	487..	-	487..

*The radial load of type TRE is limited by the interchangeable inserts (page 37)

*observe the load graphs

Radial and axial loads for a bearing life of 2000 operating hours (see calculation example page 11)

Radial – Types TRS/TRV Capto

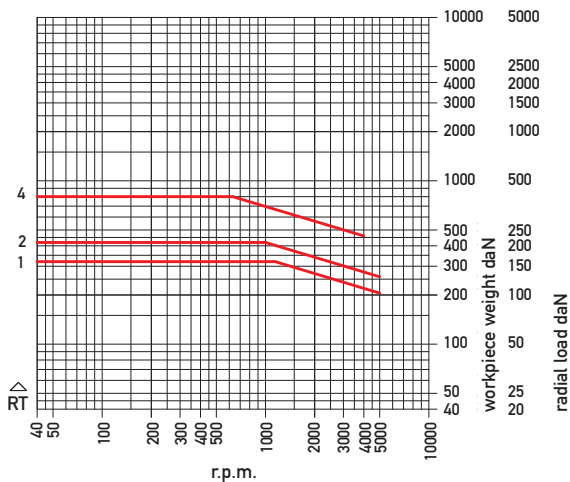

Axial – Types TRS/TRV Capto

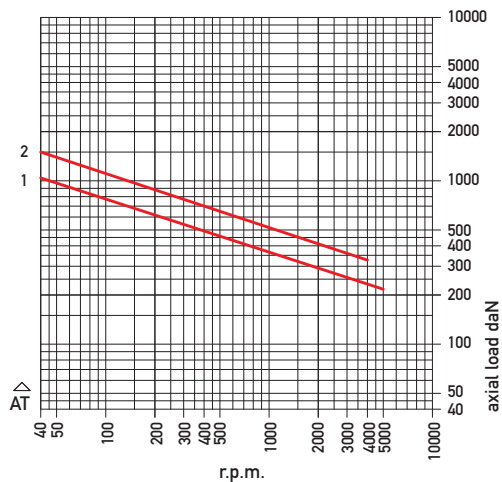

Cylindrical shank

Type TRE – centre spindle with internal taper 1:7.5 for interchangeable inserts (page 37)
 centrepoint 60° on request

Runout

max. 0.005 mm with test report
 max. 0.003 mm high precision design on request.

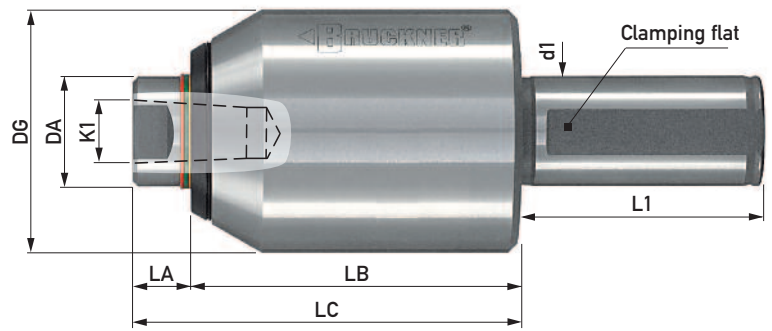

Interchangeable inserts for type TRE on page 37

Type TRE	ID.No.	700E 055Zyl25.4	700E 055Zyl25	700E 055Zyl32	700E 068Zyl32	700E 068Zyl40
Shaft size d1		25.4 (1")	25	32	32	40
DG		55	55	55	68	68
DA		25	25	25	35	35
K1		15	15	15	22	22
LA		13	13	13	21	21
LB		74	74	74	89	89
LC		87	87	87	110	110
L1		55	55	65	65	80
Spring travel		2.7	2.7	2.7	4.2	4.2
r.p.m. max.		5000	5000	5000	4000	4000
Suitable inserts		484..	484..	484..	487..	487..
Load	The radial load of type TRE is limited by the interchangeable inserts (page 37)					

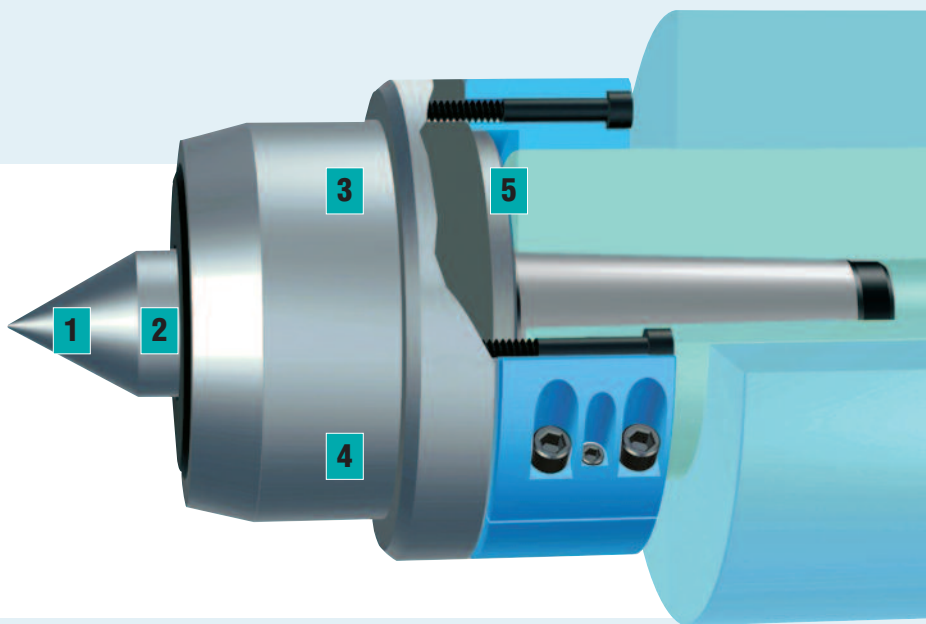

1 High concentricity accuracy

2 Shaft seal ring
protects the bearings from dirt and coolant

3 Housing
high quality material, forged, therefore uniform grain structure, tensile strength approx. 1000 N/mm²
Head and shank hardened

4 Large zero clearance precision roller bearings
to absorb radial and axial forces. No bearings in the taper shank. Bearing seats in the housing and on the centre spindle are precision ground to ultra fine tolerances. The bearings and their seats are selected for optimum fit. Maintenance-free due to permanent lubrication

5 Safety spigot (patented)
acts as an additional safeguard when connecting the centre housing to the support ring

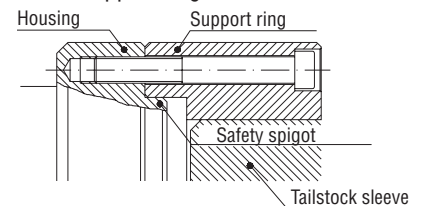

Heavy workpieces – safe clamping, precision machining

The live centre is an important element in a load system of a heavy-duty machine tool and plays a decisive role in the final machining result. The BRUCKNER design is especially suited to the high requirements of heavy-duty machining.

The maximum admissible load depends on the mounting taper diameter and we therefore offer a choice of two different designs:

- ▶ Load carried only on the taper
- ▶ Load carried on the taper with additional tailstock-sleeve support

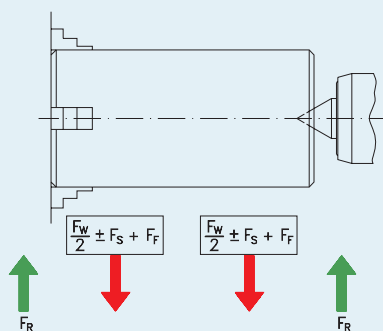

The formula is applicable when the workpiece weight F_W is equally divided between headstock and tailstock. If the component has an irregular shape, the weight has to be split up correspondingly. The radial cutting force F_S has to be either a positive or negative figure, depending on the direction of rotation. Any unbalance of the workpiece has to be allowed for with the centrifugal force F_F .

Load capacity of live centres for heavy-duty machining

The data for workpiece weight and load given in our tables and diagrams are based on the dynamic state of the live centre. Taper and centrepoint cross sections are designed for actual operating criteria and not for static conditions. The load figures are calculated for the average diameter of the 60° angle.

The radial load measured on the clamping diameter of workpiece and centrepoint is relevant. The load can be determined by the following approximation formula:

$$F_R = \frac{F_W}{2} \pm F_S + F_F$$

- F_R – radial load
- F_W – workpiece weight
- F_S – Radial cutting forces
- F_F – centrifugal force

BRUCKNER high performance live centres for heavy duty machining are used on lathes and cylindrical grinding machines in the heavy industry. Manufacturers of turbines, large engines, rollers, machined parts for the oil industry etc. focus on BRUCKNER high performance live centres due to their reliability, safety and accuracy.

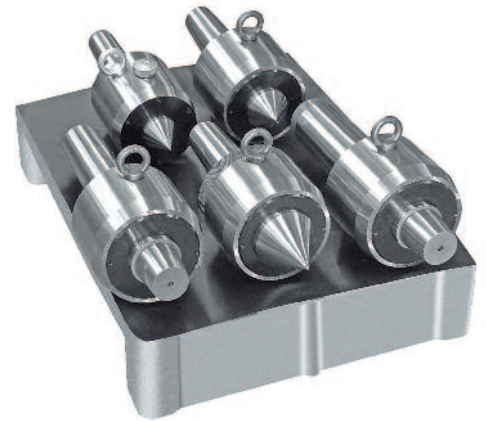

Load values

The load values given in our tables are calculated with the world wide acknowledged software KISSsoft. When used in keeping with currently valid standards DIN and ISO, this software guarantees a safe and reliable load calculation.

Types M, MG

Centrepoint 60°, 75°, 90°

Types AM, AMG

With draw-off thread

Centrepoint 60°, 75°, 90°

for machines with tailstock sleeves without through bore

Runout

Type M, AM max. 0.008 mm

Type MG, AMG max. 0.004 mm

Types MG, 141006, 141006A max. 0.003 mm

Application

For turning and grinding of heavy components, e.g. turbines, rolls, crankshafts for large engines, heavy transmission components

For operations with heavy coolant flows we recommend the use of our supplementary seal (page 10)

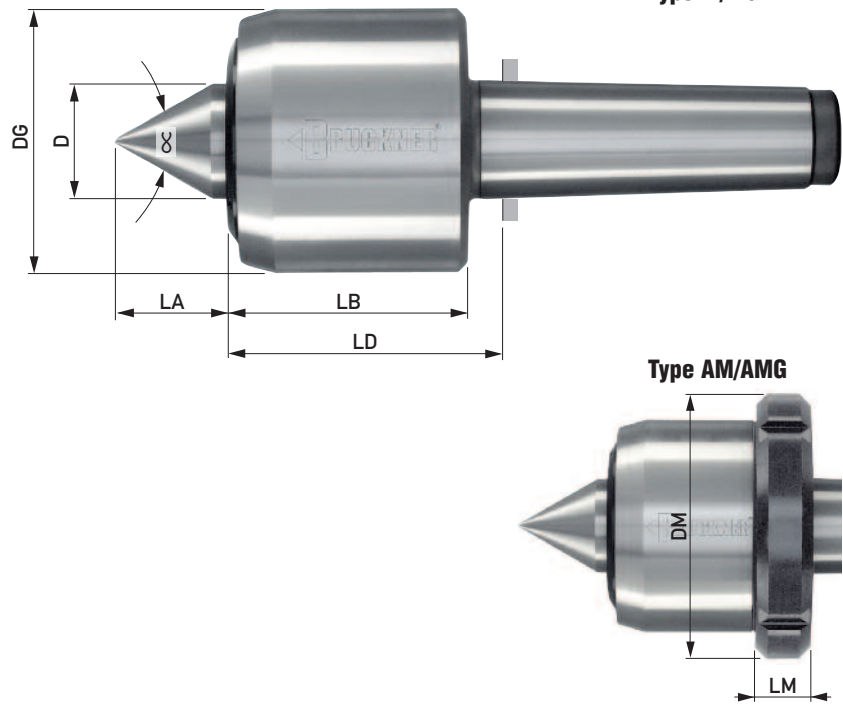

Type M	ID.No.	140006	140081	180007	180080	180081	180100	180101	230120	230121
Type MG	ID.No.	141006	141081	181007	181080	181081	181100	181101	231120	231121
Type AM	ID.No.	140006A	140081A	180007A	180080A	180081A	180100A	180101A	on request	
Type AMG	ID.No.	141006A	141081A	181007A	181080A	181081A	181100A	181101A		
Taper size		MT 6	Taper 80 1:10	MT 7	Metr. 80 1:20	Taper 80 1:10	Metr. 100 1:20	Taper 100 1:10	Metr. 120 1:20	Taper 120 1:10
D		62	62	80	80	80	80	80	100	100
DG		140	140	180	180	180	180	180	230	230
LA for $\angle \infty$	standard	60°	60	60	77	77	77	77	88	88
	optional	75°	47	47	60	60	60	60	60	68
		90°	38	38	49	49	49	49	49	54
LB		124	124	146	146	146	146	146	183	183
LD		135	142	164	164	164	164	164	201	201
Workpiece weight max. daN*		6000	6000	10000	10000	10000	15000	15000	25000	25000
r.p.m. max. *		1600	1600	1200	1200	1200	1200	1200	1100	1100
Radial/axial load graph		RM1/AM1	RM1/AM1	RM2/AM2	RM2/AM2	RM2/AM2	RM3/AM2	RM3/AM2	RM4/AM3	RM4/AM3
Supplementary seal	ID.No.	V60	V60	V80	V80	V80	V80	V80	V100	V100
Draw-off nut for Typ AM, AMG	ID.No.	M140A	M140A	M180A	M180A	M180A	M180A	M180A		
DM		175	175	210	210	210	210	210		
LM		36	36	40	40	40	40	40		

*observe the load graphs

Radial and axial loads for a bearing life of 2000 operating hours (see calculation example page 11)

Radial – Types M, MG, AM, AMG

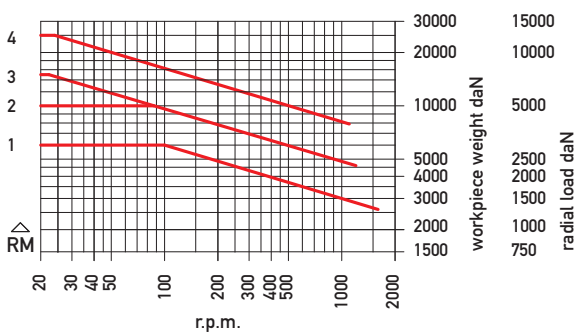

Axial – Types M, MG, AM, AMG

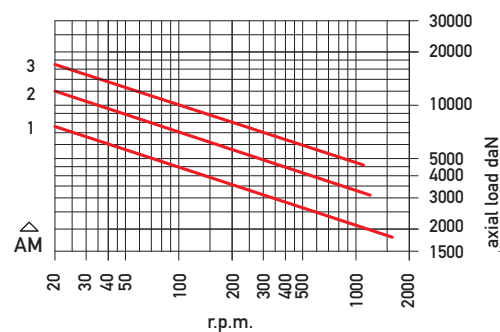

Types MR, MRG

with tailstock sleeve support ring
and patented safety spigot
Centrepoint 60°, 75°, 90°

Runout

Type MR max. 0.008 mm

Type MRG max. 0.004 mm

Application

If, for very high workpiece weights the load capacity on the mounting taper is insufficient, the centre is additionally supported on the tailstock sleeve with a support ring. A patented safety spigot safeguards the screw fastening of the centre housing to the support ring.

The support also diminishes vibration and enhances the centre life.

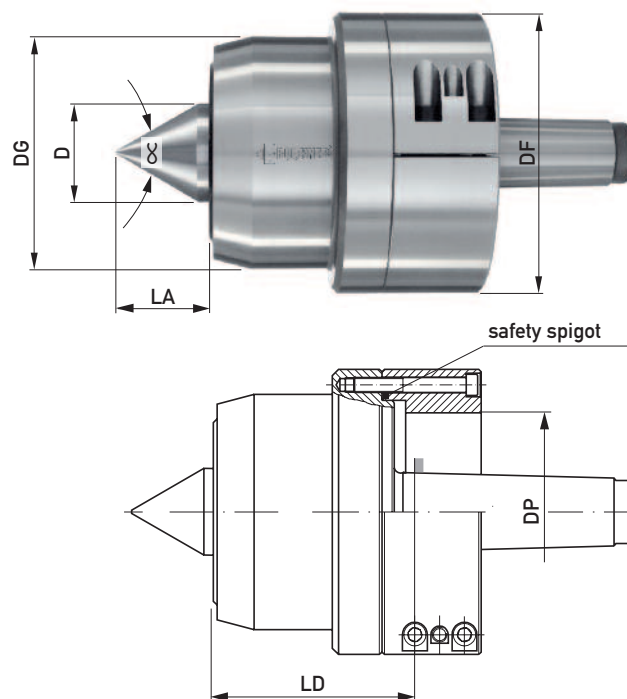

Type MR	ID.No.	190006MR	190007MR	190080MR	190081MR	230100MR	230101MR
Type MRG	ID.No.	191006MR	191007MR	191080MR	191081MR	231100MR	231101MR
Taper size		MT 6	MT 7	Metr. 80 1:20	Taper 80 1:10	Metr. 100 1:20	Taper 100 1:10
D		80	80	80	80	100	100
DG		190	190	190	190	230	230
LA for $\angle \infty$	standard	60°	77	77	77	88	88
	optional	75°	60	60	60	68	68
		90°	49	49	49	49	54
LD		157	164	164	164	201	201
DF		230	230	230	230	230	230
DP		100-180	100-180	100-180	100-180	100-180	100-180
Workpiece weight max. daN*		10 000	15 000	15 000	15 000	20 000	20 000
r.p.m. max.*		1200	1200	1200	1200	1100	1100
Radial/axial load graph		RP1/AP1	RP2/AP1	RP2/AP1	RP2/AP1	RP3/AP2	RP3/AP2
Supplementary seal	ID.No.	V80	V80	V80	V80	V100	V100

*observe the load graphs

When inquiring/ordering please indicate:

1. Point angle of the centre
2. For design with support ring the tailstock sleeve diameter within 0.01 mm

Radial and axial loads for a bearing life of 2000 operating hours (see calculation example page 11)

Radial – Types MR, MRG

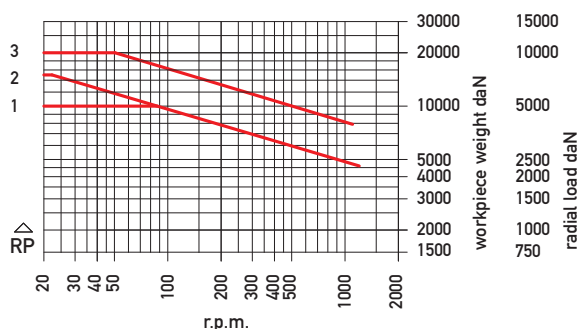

Axial – Types MR, MRG

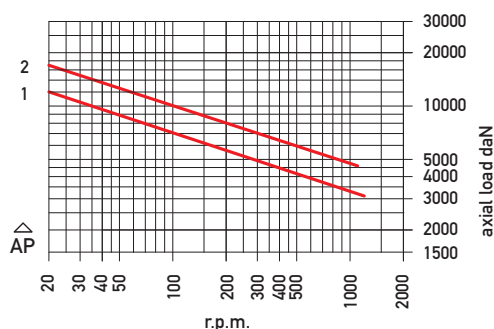

Type MZ

with expansion compensation
and pressure indication by graduated dial
Centrepoint 60°, 75°, 90°

Runout

max. 0.008 mm
max. 0.004 mm on request

Application

If the axial pressure must not exceed or fall below a defined value to clamp the component safely or to avoid workpiece deformation.

When machining heavy workpieces prone to heat expansion.

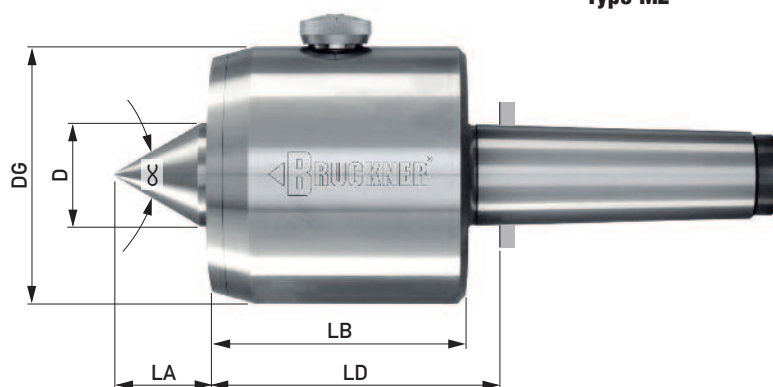

Type MZ

Type MZ without draw-off thread

Type AMZ with draw-off thread

for machines with tailstock sleeve
without through bore (draw-off nut page 44)

Type MZR with tailstock sleeve support ring and patented safety spigot (page 42)

The tailstock sleeve support:

- ▶ makes the connection between tailstock sleeve and centre housing sturdier
- ▶ minimises the possibility of machining vibrations

We recommend our tailstock sleeve support design when

- ▶ machining heavy workpieces, unbalanced and/or interrupted cuts
- ▶ high quality workpiece surface finishes are required

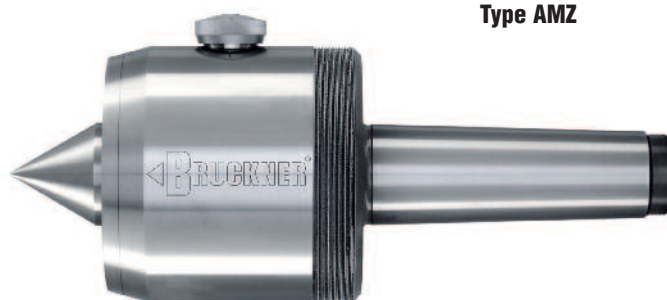

Type AMZ



Type MZR

Adjusting the clamping pressure

The tailstock pressure required is adjusted on the graduated dial. When clamping the component, the central measuring pin is lifted in proportion to the travel of the centre spindle.

The required clamping force is reached when measuring pin and scaling ring surface are level.



Pressure too low



Correct pressure

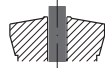

Pressure too high

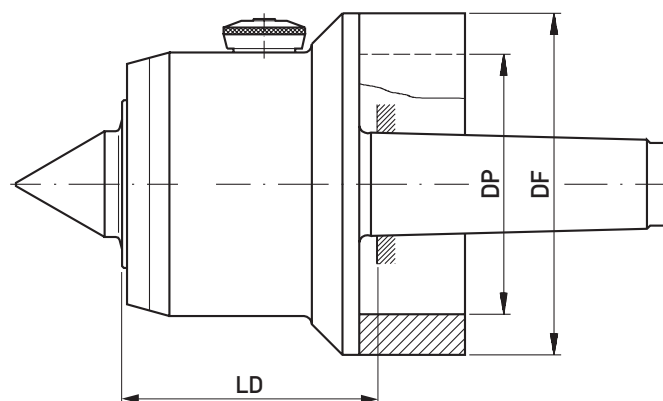

Type MZ	ID.No.	MZ164006	MZ194M080	MZ194K080	MZ194M100	MZ194K100	MZ224M100	MZ224K100
Type AMZ	ID.NO.	MZ164006A	MZ194M080A	MZ194K080A	MZ194M100A	MZ194K100A	on request	on request
Taper size		MT 6	Metr. 80 1:20	Taper 80 1:10	Metr. 100 1:20	Taper 100 1:10	Taper 100 1:20	Taper 100 1:10
D		65	90	90	90	90	100	100
DG		160	190	190	190	190	220	220
LA for $\angle \infty$	standard	60°	62	86	86	86	86	95
	optional	75°	48.5	67.5	67.5	67.5	67.5	74
		90°	39	54	54	54	54	60
LB		157	169	169	169	169	187	187
LD		168	187	187	187	187	205	205
Workpiece weight max. daN*		6000	10000	10000	10000	10000	15000	15000
r.p.m. max.*		1600	850	850	850	850	750	750
Initial pressure daN*		800	1200	1200	1200	1200	1500	1500
Final pressure daN*		8000	12000	12000	12000	12000	16200	16200
Max. travel of spring system mm		2.3	2.8	2.8	2.8	2.8	2.9	2.9
Radial/axial load graph		RX1/AX1	RX2/AX2	RX2/AX2	RX2/AX2	RX2/AX2	RX3/AX3	RX3/AX3
Draw-off nut for Type AMZ**	ID.No.	M140 A	M180 A	M180 A	M180 A	M180 A		

**dimensions of draw-off nut page 44

*observe the load graphs

Type MZR	ID.No.	MZR194006	MZR194M080	MZR194K080	MZR224M080	MZR224K080
Taper size		MT 6	Metr. 80 1:20	Taper 80 1:10	Metr. 80 1:20	Taper 80 1:10
D		90	90	90	100	100
DG		190	190	190	220	220
DF		230	230	230	230	230
DP		100-180	100-180	100-180	100-180	100-180
LD		180	187	187	205	205
Workpiece weight max. daN*		10000	10000	10000	15000	15000
Radial/axial load graph		RX2/AX2	RX2/AX2	RX2/AX2	RX3/AX3	RX3/AX3

**All other dimensions see similar type MZ

*observe the load graphs

When inquiring/ordering please indicate:

1. Point angle of the centre
2. For type MZR the tailstock sleeve diameter within 0.01 mm

Radial and axial loads for a bearing life of 2000 operating hours (see calculation example page 11)

Radial – Types MZ, AMZ, MZR

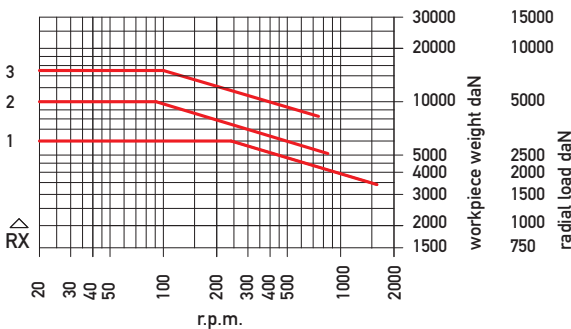

Axial – Types MZ, AMZ, MZR

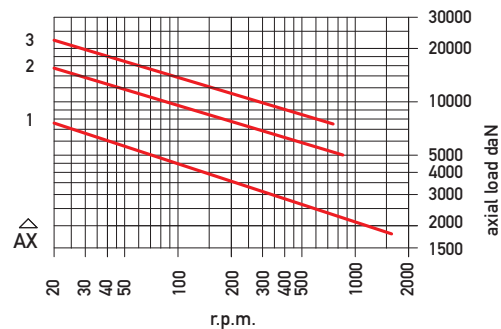

BRUCKNER WORKS STANDARD

Our high performance bullnose live centres – standard as well as special designs – are produced and tested according to our own stringent works standard. Materials, production and testing are subject to strict quality guidelines guaranteeing function and performance of our tools.

Test report for concentricity accuracy

Every single BRUCKNER high performance bullnose live centre is tested for its run-out under axial load. The test result is then stamped into the centre and is guaranteed by the test report and quality guidelines guaranteeing function.



Example: table „maximum runout“ for types ZA, ZAG

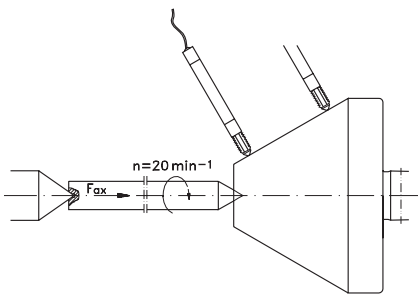

Type ZA	Type ZAG	Morse taper	Runout max.		Fax daN
			Type ZA	Type ZAG	
1920-1922	2120-2122	2	0.007	0.003	160
1930	2130	3	0.007	0.003	160
1831-1933	2031-2133	3	0.007	0.003	210
1841-1941	2041-2141	4	0.007	0.003	210
1942-1947	2142-2147	4	0.007	0.003	450
1952	2152	5	0.007	0.003	450
1953	2153	5	0.007	0.003	600
1954-1959	2154-2159	5	0.007	0.003	600
1964-1970	2164-2170	6	0.007	0.003	600
1983-1985	2183-2185	6	0.007	0.003	600

Bullnose centre head and taper shank

The bullnose centre head is of wear-resistant, through-hardened alloy tool steel. In contrast to usual case-hardening, this allows the head of the centre to be reground several times without any loss of hardness. The taper shank is case hardened for protection from damage.

Tolerance of taper shank

The Morse taper is ground according to DIN 228 AT4 (gauge accuracy). This fine tolerance guarantees a close fit of the high performance bullnose centre in the tailstock and the full utilisation of the concentricity accuracy.

Load values

The load values given in our tables are calculated with the world wide acknowledged software KISSsoft. When used in keeping with currently valid standards DIN and ISO, this software guarantees a safe and reliable load calculation.

Precision bearings

The bearings are selected according to the size of the Morse taper. The bearing seats of the head and the taper shank are matched to the bearings and ground to precise tolerances. Bearings and their seats are selected to fit.

Result: high stability, minimum runout and long life.

Maintenance

The bearings are maintenance free due to permanent lubrication.

Repair service

Our repair service is at your disposal. We judge the tool's condition and inform you about the extent of necessary refurbishment.



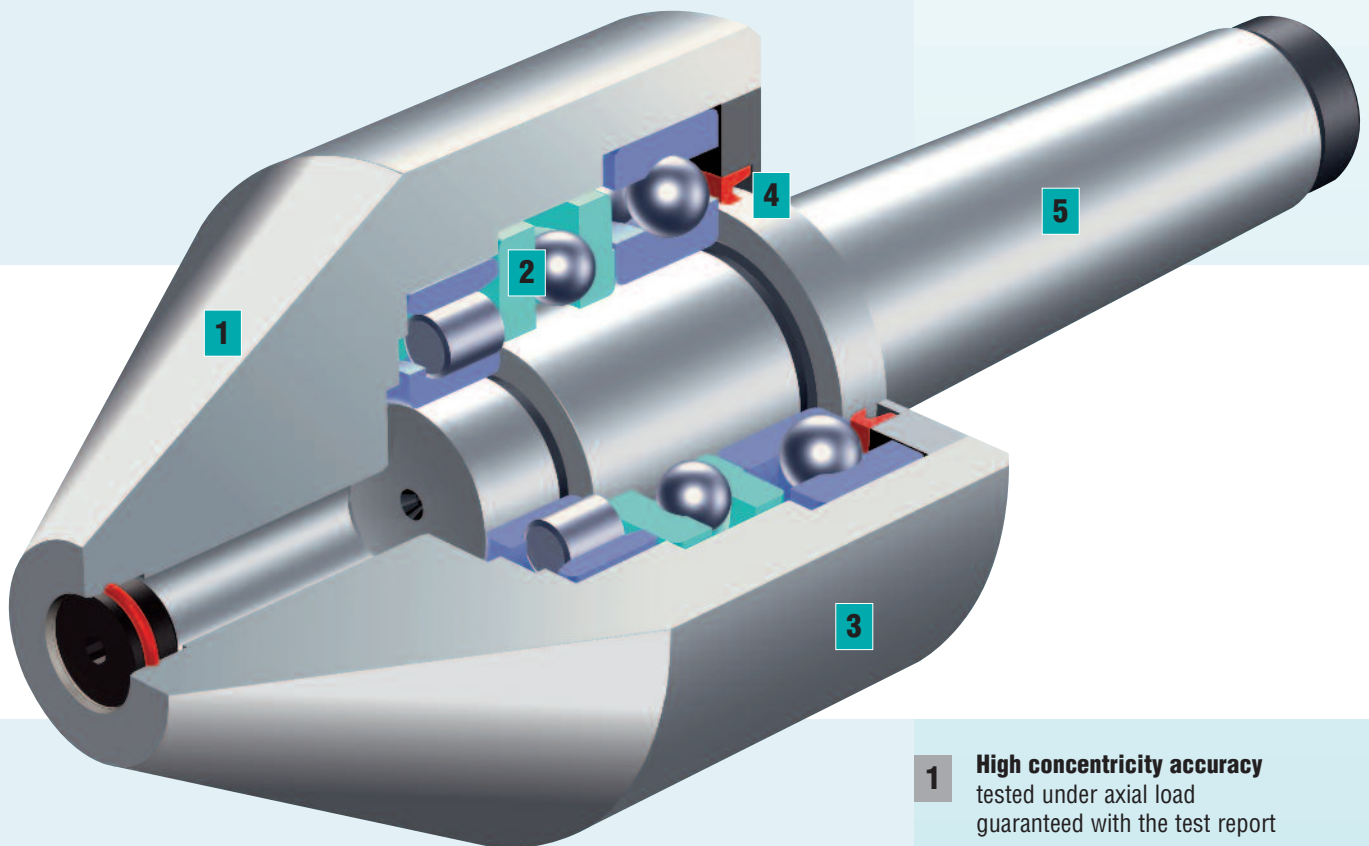

Robust and precise

Our bullnose live centres have sturdy roller bearings where the loads are heaviest. Combined with large axial and radial deep section ball bearings this design allows high loads with high concentricity and long life. BRUCKNER bullnose live centres sustain their reliability even when conditions are tough. For cylindrical grinding operations BRUCKNER bullnose live centres are market leaders. Such work demands bullnose centres with reserves of stability for good grinding results.

- 1 High concentricity accuracy**
tested under axial load
guaranteed with the test report
- 2 Large precision roller bearings, free from clearance**
to withstand the axial and radial forces.
Maintenance-free due to permanent lubrication
- 3 Bullnose head**
of alloy tool steel, through-hardened
- 4 Shaft seal**
protects the bearings from dirt and coolant
- 5 Taper shank**
case hardened for protection from damage

Types ZA, ZAG

Angle 60°, 75°
without draw-off thread

Runout

Type ZA max. 0.007 mm
Type ZAG max. 0.003 mm
with test report

Application

For turning and grinding tubes and workpieces with large bores

Mechanical engineering

Main spindles for machine tools, hollow shafts, paper rolls, rings and gears

Car industry/Motor construction

Truck axial tubes, pistons, cylinder liners, crankshafts, wheel hubs

Aircraft industry/Shipbuilding

Engine main shafts and transmission components, turbines, drive shafts

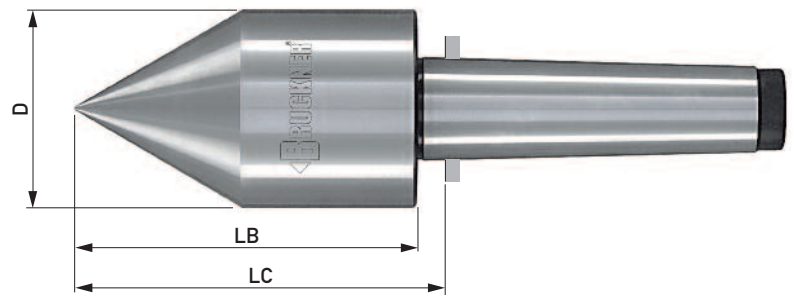
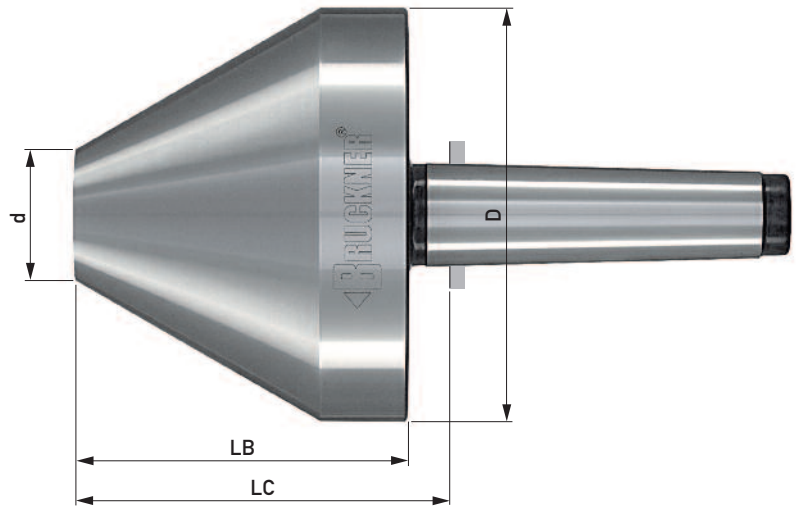

Radial and axial loads for a bearing life of 2000 operating hours (see calculation example page 11)

Radial – Types ZA, ZAG without draw-off-thread

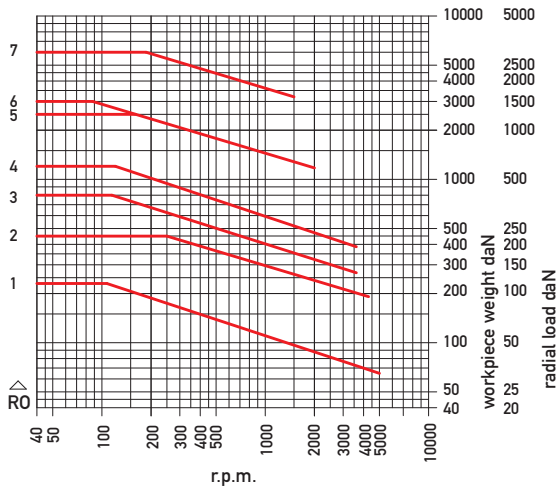

Axial – Types ZA, ZAG without draw-off-thread

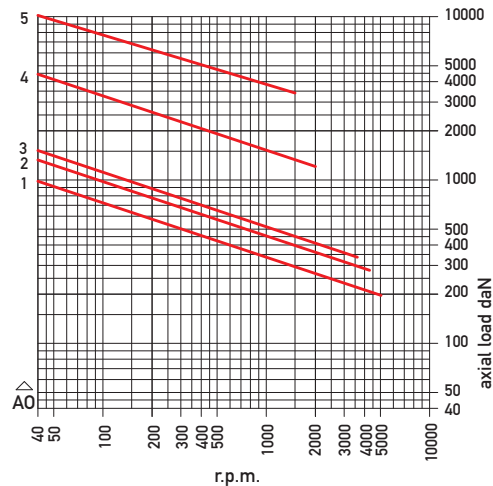

Types ZA, ZAG 60° without draw-off thread										
Morse taper	ID.No.		D	d	LC	LB	Workpiece weight max. daN*	r.p.m. max.*	Load graph	
	ZA	ZAG							radial	axial
2	1920:60	2120:60	45	15	78	70	230	5000	R01	A01
2	1821:60	2021:60	60	1	93	85				
2	1921:60	2121:60	60	20	74	66				
2	1922:60	2122:60	80	25	70	62				
3	1930:60	2130:60	45	15	78	70				
3	1831:60	2031:60	60	1	111	104	450	4300	R02	A02
3	1931:60	2131:60	60	20	95	88				
3	1932:60	2132:60	80	25	95	88				
3	1933:60	2133:60	100	35	95	88				
4	1841:60	2041:60	60	1	113	104				
4	1941:60	2141:60	60	20	97	88	1200	3600	R04	A03
4	1942:60	2142:60	80	25	113	100				
4	1943:60	2143:60	100	35	113	100				
4	1944:60	2144:60	125	40	113	100				
4	1945:60	2145:60	150	50	113	100				
4	1947:60	2147:60	200	75	135	122	800	3600	R03	A03
5	1952:60	2152:60	80	25	113	100	1200	3600	R04	A03
5	1953:60	2153:60	100	35	113	100				
5	1954:60	2154:60	125	40	144	130	2500	2000	R05	A04
5	1955:60	2155:60	150	50	136	122				
5	1957:60	2157:60	200	75	136	122				
5	1958:60	2158:60	250	130	136	122				
5	1959:60	2159:60	300	180	136	122				
6	1964:60	2164:60	125	40	146	130	3000	2000	R06	A04
6	1965:60	2165:60	150	50	138	122				
6	1967:60	2167:60	200	75	138	122				
6	1968:60	2168:60	250	130	138	122				
6	1969:60	2169:60	300	180	138	122				
6	1970:60	2170:60	350	230	138	122	6000	1500	R07	A05
6	1983:60	2183:60	250	100	176	160				
6	1985:60	2185:60	350	180	186	170				

Bullnose centres with other shanks on request

*observe the load graphs

Types ZA, ZAG 75° without draw-off thread										
Morse taper	ID.No.		D	d	LC	LB	Workpiece weight max. daN*	r.p.m. max.*	Load graph	
	ZA	ZAG							radial	axial
5	1953:75	2153:75	100	25	109	96	1200	3600	R04	A03
5	1954:75	2154:75	125	30	144	130				
5	1955:75	2155:75	150	50	134	120	2500	2000	R05	A04
5	1957:75	2157:75	200	75	124	110				
5	1958:75	2158:75	250	110	124	110				
5	1959:75	2159:75	300	160	124	110				
6	1964:75	2164:75	125	30	146	130				
6	1965:75	2165:75	150	50	136	120	3000	2000	R06	A04
6	1967:75	2167:75	200	75	126	110				
6	1968:75	2168:75	250	110	126	110				
6	1969:75	2169:75	300	160	126	110				
6	1970:75	2170:75	350	190	138	122				
6	1983:75	2183:75	250	75	181	165	6000	1500	R07	A05
6	1985:75	2185:75	350	120	186	170				

Bullnose centres with other shanks on request

*observe the load graphs

Types ZA, ZAG

Angle 60°, 75°

With draw-off thread and draw-off nut

Runout

Type ZA max. 0.007 mm

Type ZAG max. 0.003 mm

with test report

Application

As for types ZA/ZAG on page 50, but for machine tools with tailstock sleeves without through bores (without the possibility to eject centres) or for high precision machine tools for the protection of the spindle bearings or the tailstock sleeve

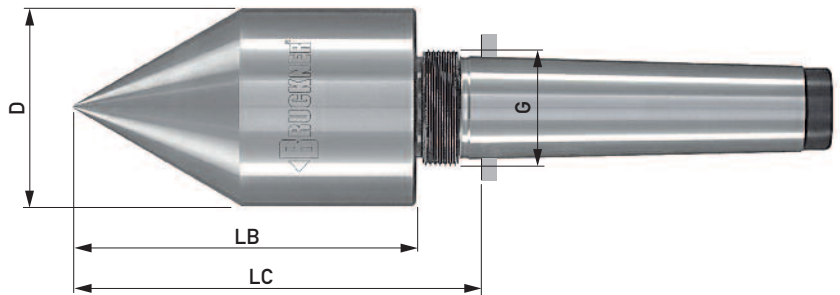
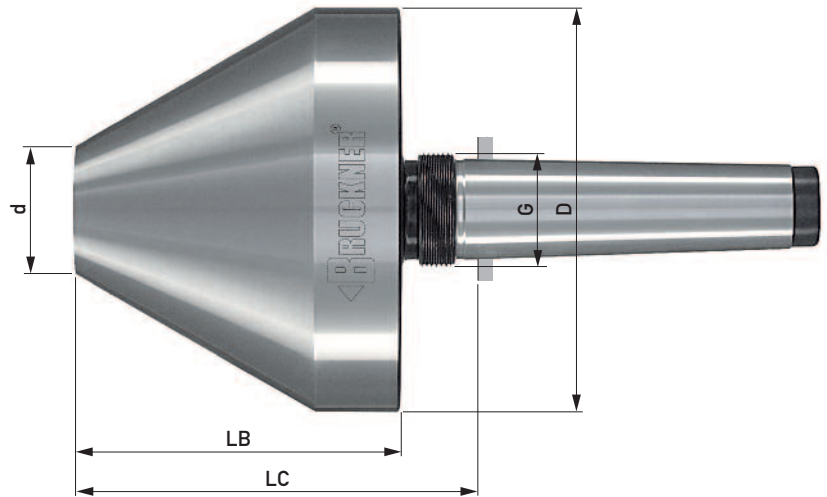

Radial and axial loads for a bearing life of 2000 operating hours (see calculation example page 11)

Radial – Types ZA, ZAG with draw-off thread

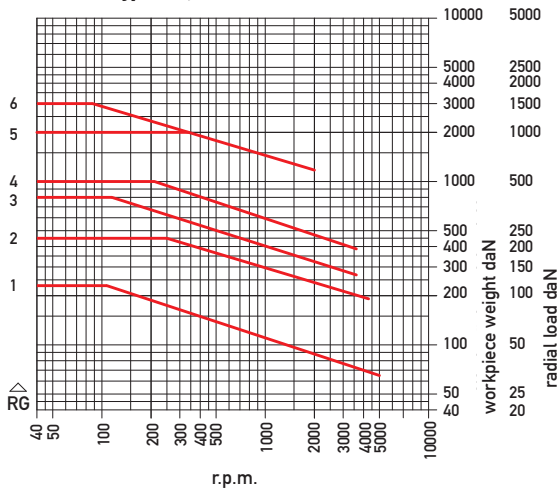

Axial – Types ZA, ZAG with draw-off thread

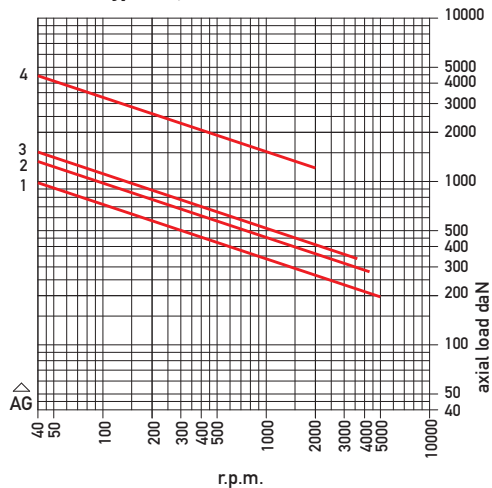

Types ZA, ZAG 60° with draw-off thread and draw-off nut											
Morse taper	ID.No.		D	d	LC	LB	G	Workpiece weight max. daN*	r.p.m. max.*	Load graph	
	ZA	ZAG								radial	axial
2	1920:60A	2120:60A	45	15	86	70	M 22x1.5	230	5000	RG1	AG1
2	1821:60A	2021:60A	60	1	101	85	M 22x1.5				
2	1921:60A	2121:60A	60	20	82	66	M 22x1.5				
2	1922:60A	2122:60A	80	25	78	62	M 22x1.5				
3	1930:60A	2130:60A	45	15	86	70	M 28x1.5	450	4300	RG2	AG2
3	1831:60A	2031:60A	60	1	120	104	M 28x1.5				
3	1931:60A	2131:60A	60	20	104	88	M 28x1.5				
3	1932:60A	2132:60A	80	25	104	88	M 28x1.5				
3	1933:60A	2133:60A	100	35	104	88	M 28x1.5	1000	3600	RG4	AG3
4	1841:60A	2041:60A	60	1	120	104	M 35x1.5				
4	1941:60A	2141:60A	60	20	104	88	M 35x1.5				
4	1942:60A	2142:60A	80	25	119	100	M 35x1.5				
4	1943:60A	2143:60A	100	35	119	100	M 35x1.5	800	3600	RG3	AG3
4	1944:60A	2144:60A	125	40	119	100	M 35x1.5				
4	1945:60A	2145:60A	150	50	119	100	M 35x1.5				
4	1947:60A	2147:60A	200	75	141	122	M 35x1.5				
5	1952:60A	2152:60A	80	25	129	100	M 48x1.5	1000	3600	RG4	AG3
5	1953:60A	2153:60A	100	35	129	100	M 48x1.5				
5	1954:60A	2154:60A	125	40	158	130	M 50x1.5	2000	2000	RG5	AG4
5	1955:60A	2155:60A	150	50	150	122	M 50x1.5				
5	1957:60A	2157:60A	200	75	150	122	M 50x1.5				
5	1958:60A	2158:60A	250	130	150	122	M 50x1.5				
5	1959:60A	2159:60A	300	180	150	122	M 50x1.5	3000	2000	RG6	AG4
6	1964:60A	2164:60A	125	40	159	130	M 68x1.5				
6	1965:60A	2165:60A	150	50	151	122	M 68x1.5				
6	1967:60A	2167:60A	200	75	151	122	M 68x1.5				
6	1968:60A	2168:60A	250	130	151	122	M 68x1.5	3000	2000	RG6	AG4
6	1969:60A	2169:60A	300	180	151	122	M 68x1.5				
6	1970:60A	2170:60A	350	230	151	122	M 68x1.5				

Bullnose centres with other shanks on request

*observe the load graphs

Types ZA, ZAG 75° with draw-off thread and draw-off nut											
Morse taper	ID.No.		D	d	LC	LB	G	Workpiece weight max. daN*	r.p.m. max.*	Load graph	
	ZA	ZAG								radial	axial
5	1953:75A	2153:75A	100	25	125	96	M 48x1.5	1000	3600	RG4	AG3
5	1954:75A	2154:75A	125	30	158	130	M 50x1.5	2000	2000	RG5	AG4
5	1955:75A	2155:75A	150	50	148	120	M 50x1.5				
5	1957:75A	2157:75A	200	75	138	110	M 50x1.5				
5	1958:75A	2158:75A	250	110	138	110	M 50x1.5				
5	1959:75A	2159:75A	300	160	138	110	M 50x1.5	3000	2000	RG6	AG4
6	1964:75A	2164:75A	125	30	159	130	M 68x1.5				
6	1965:75A	2165:75A	150	50	149	120	M 68x1.5				
6	1967:75A	2167:75A	200	75	139	110	M 68x1.5				
6	1968:75A	2168:75A	250	110	139	110	M 68x1.5	3000	2000	RG6	AG4
6	1969:75A	2169:75A	300	160	139	110	M 68x1.5				
6	1970:75A	2170:75A	350	190	151	122	M 68x1.5				

Bullnose centres with other shanks on request

*observe the load graphs

BRUCKNER WORKS STANDARD

Our high performance live centres – standard as well as special designs – are produced and tested according to our works standard. Materials, production and testing are subject to strict quality guidelines guaranteeing function and performance.

Regrinding line

As a rule, BRUCKNER centres feature a regrinding line showing the useful end of the carbide. Forms R and GR do not have this line. Here the useful limit is marked by the braze line.



Regrinding line

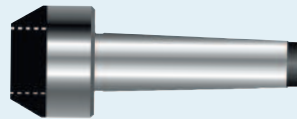

Braze line (form R/GR)

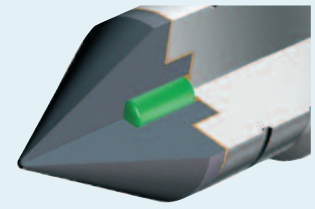

sa•co®

safety core from BRUCKNER

In BRUCKNER solid carbide dead centres (forms V, GV, Z, GZ and HZ) with a carbide diameter of 20 to 45 mm the **safety core sa•co®** is integrated. If there is a fissure in the joint between carbide and base material, e.g. caused by operating or handling errors, **sa•co®** prevents the carbide point with the mounted workpiece from slipping. Thus high consequential costs are avoided.

Extract from DIN 806, DIN 228 and BRUCKNER WORKS STANDARD

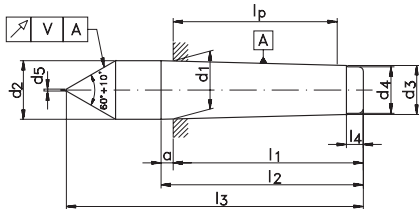

V = permissible eccentricity
Z = maximum taper error
 taper increasing towards the large diameter along the tested length l_p

Taper size	DIN										DIN	BRUCKNER WORKS STANDARD		
	d ₁	d ₂	d ₃	d ₄	d ₅	l ₁	l ₂	l ₃	l ₄	a	V	V	Z	
Morse taper	0	9.045	9.2	6.4	6	0.5	50	53	70	4	3	0.01	0.003	0.002
	1	12.065	12.2	9.4	9	0.5	53.5	57	80	5	3.5	0.01	0.003	0.003
	2	17.78	18.0	14.6	14	0.8	64	69	100	5	5	0.01	0.003	0.003
	3	23.825	24.1	19.8	19	0.8	81	86	125	7	5	0.01	0.004	0.004
	4	31.267	31.6	25.9	25	1	102.5	109	160	9	6.5	0.01	0.004	0.005
	5	44.399	44.7	37.6	36	1.6	129.5	136	200	10	6.5	0.01	0.004	0.006
Metric taper	6	63.348	63.8	53.9	51	2	182	190	270	16	8	0.01	0.004	0.006
	80	80	80.4	70.2	67	*	196	204	*	24	8	*	0.005	0.006
	100	100	100.5	88.4	85	*	232	242	*	30	10	*	0.005	0.007
	120	120	120.6	106.6	102	*	268	280	*	36	12	*	0.005	0.008

* not standardized

User information

In our „User information“ you will find hints and tips for the use of our carbide centres, e. g. on work safety, causes and removal of roundness errors on the workpiece etc.

Please advise us if you would like copies.



Repair service

We check the dead centre (also other makes) for:

- ▶ Damage/cracks in the carbide
- ▶ Sufficient fixing of the carbide in the base material
- ▶ Damaged taper shank

We inform you about the extent of the necessary repair/regrinding work with a cost estimate.

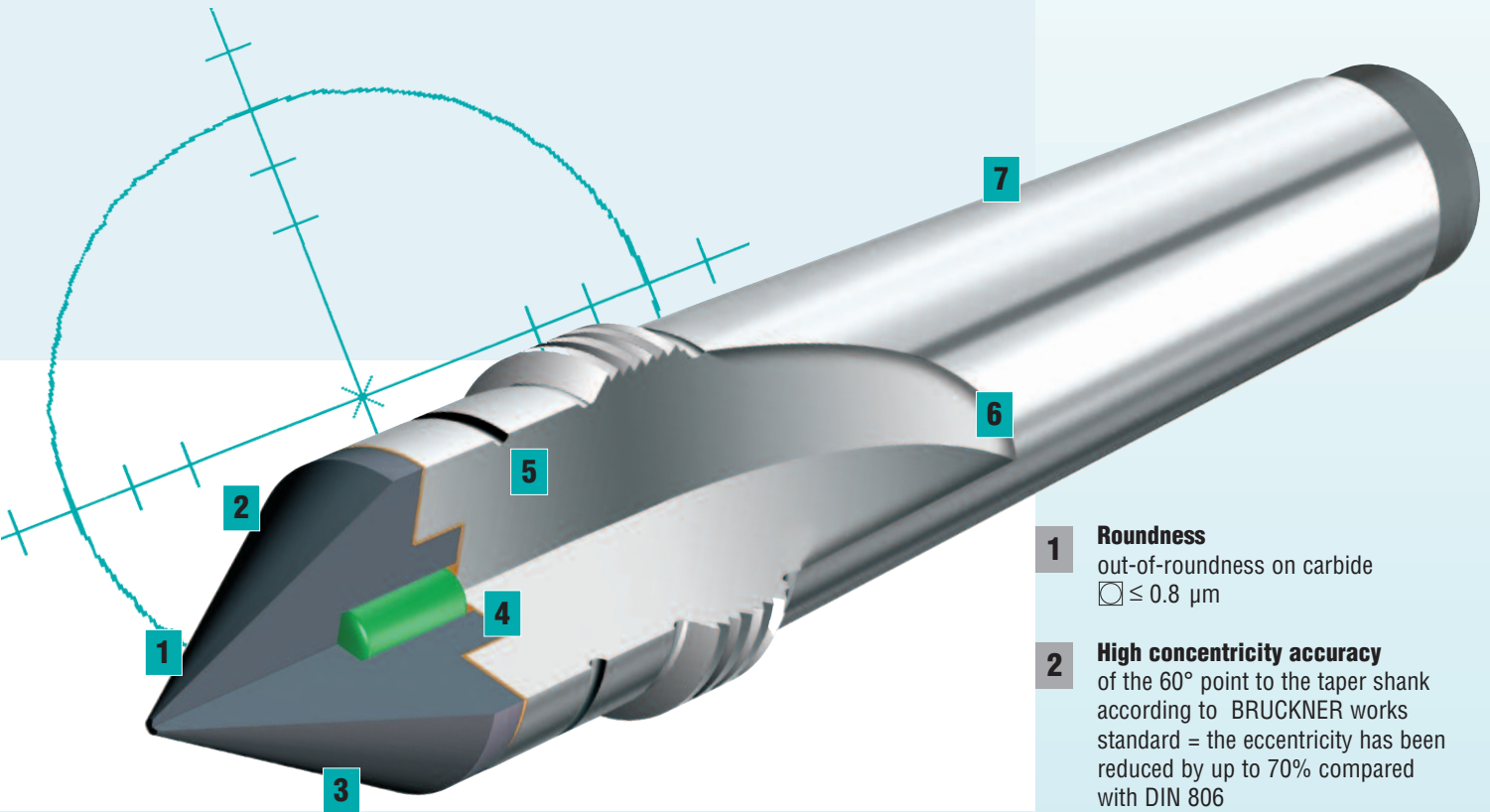

BRUCKNER carbide dead centres – the benchmark

Due to their superior roundness and high product quality BRUCKNER dead centres set the benchmark in terms of economic efficiency and productivity. Our know-how, our experience and our background in the high precision manufacture of our centres guarantee the features of our own products at the highest level.

The BRUCKNER guarantee for standard dead centres
Out-of-roundness $\ominus \leq 0.8 \mu\text{m}$.

We supply standard dead centres and special designs
 with **out-of-roundness** $\ominus \leq 0.3 \mu\text{m}$. Test report on request.

- 1 Roundness**
out-of-roundness on carbide
 $\ominus \leq 0.8 \mu\text{m}$
- 2 High concentricity accuracy**
of the 60° point to the taper shank according to BRUCKNER works standard = the eccentricity has been reduced by up to 70% compared with DIN 806
- 3 Top-quality carbides**
safely fixed in the base material
- 4 sa•co® – the safety core**
maximum safety through the integrated safety core (forms V, GV, Z, GZ and HZ with carbide diameter 20-45 mm)
- 5 Regrinding line**
marking the useful end of the centre
- 6 Hardened taper shank**
the taper is case hardened for protection from damage
- 7 Taper shank tolerance**
deviation of taper AT4 to DIN 228 (gauge accuracy)

Carbide Dead Centres, Full Centre 60° without Draw-Off Thread

Form E – L – V

Out-of-roundness $\square \leq 0.8 \mu\text{m}$. Morse taper hardened for protection from damage. Quality features see page 54/55.

Form	Morse taper	ID.No.	D	d2	LC	L
E	1	2801H	7	12.2	26.5	80
	2	2802H	7	18	36	100
	3	2803H	11	24.1	44	125
	4	2804H	14	31.6	57.5	160
	5	2805H	18	44.7	70.5	200
	6	2806H	18	63.8	88	270

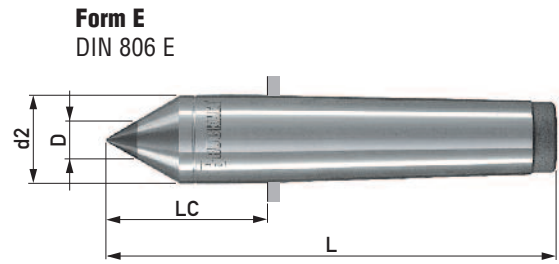

Form	Morse taper	ID.No.	D	d2	LC	L
L	2	2802.11-135	11	18	71	135
	2	2802.14	14	18	36	100
	3	2803.14	14	24.1	44	125
	3	2803.14-150	14	24.1	69	150
	4	2804.18	18	31.6	57.5	160
	4	2804.18-180	18	31.6	77.5	180
	4	2804.18-200	18	31.6	97.5	200
	5	2805.18-250	18	44.7	120.5	250
	6	2806.35	35	63.8	88	270

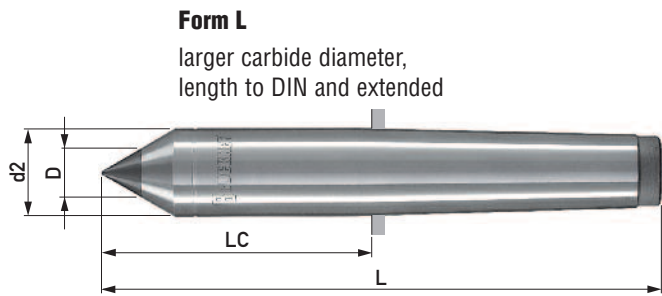

Form	Morse taper	ID.-No.	D	LC	L
V	*1	2801.12V-080	12	26.5	80
	*2	2802.18V-110	18	46	110
	2	2802.24V-110	24	46	110
	3	2803.24V-125	24.1	44	125
	3	2803.24V-150	24.1	69	150
	4	2804.32V-160	31.6	57.5	160
	4	2804.32V-180	31.6	77.5	180
	4	2804.32V-200	31.6	97.5	200
	5	2805.45V-200	44.7	70.5	200
	5	2805.45V-250	44.7	120.5	250
	**6	2806.64V-270	63.8	88	270

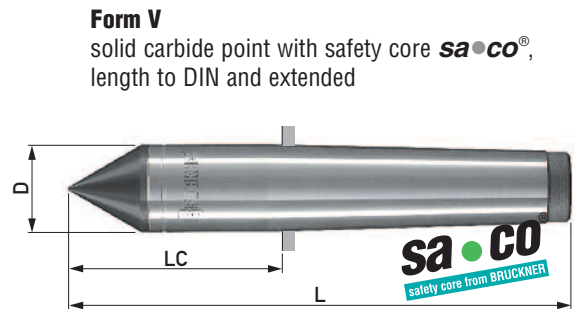

* without safety core, carbide brazed in tapered seating
** without safety core, carbide outer shell with base material core

Your Grinding Task – Our Carbide-Tipped Centres

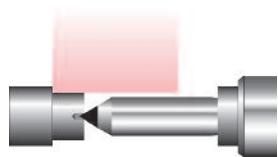

Short grinding length, wide grinding wheel, extended carbide centre
Form L

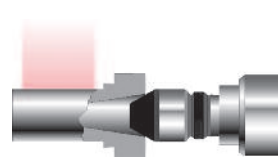

Larger centrebore, carbide centre with large truncated carbide body
Form Z, R, GR

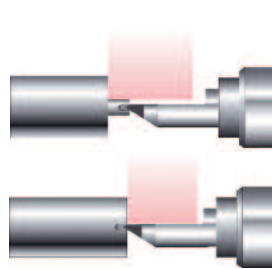

Small diameter or short grinding length or face grinding. Extended carbide half centre with extra small flat height
Form HS, GHS, HV, GHV

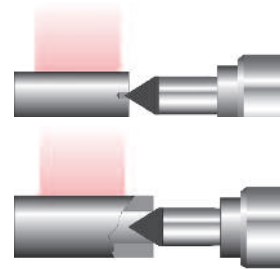

Small to large centres. Carbide centre with solid carbide 60° point
Form V, GV

Carbide Dead Centres, Full Centre 60° without Draw-Off Thread

Form Z – R – B* – HB*

Out-of-roundness $\square \leq 0.8\mu\text{m}$. Morse taper hardened for protection from damage. Quality features see page 54/55.

Form	Morse taper	ID.No.	D	d	d2	LC	L
Z	2	2802.32x10	32	10	38	46	110
	3	2803.32x10	32	10	38	50	131
	4	2804.24	24	1	31.6	57.5	160
	4	2804.32x10	32	10	38	57.5	160
	5	2805.32x10	32	10	44.7	70.5	200

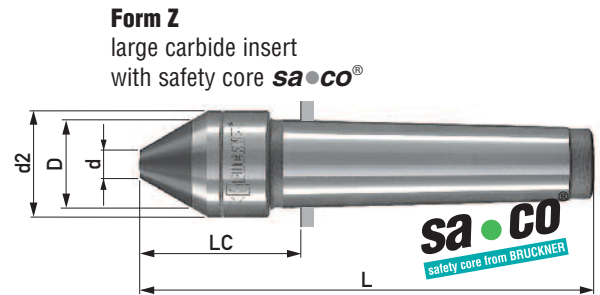

Form	Morse taper	ID.No.	D	d	LC	L
R	2	2802.40x20	40	20	41	105
	2	2802.50x30	50	30	41	105
	2	2802.60x40	60	40	41	105
	2	2802.70x50	70	50	41	105
	3	2803.40x20	40	20	44	125
	3	2803.50x30	50	30	44	125
	3	2803.60x40	60	40	44	125
	3	2803.70x50	70	50	44	125
	4	2804.40x20	40	20	57.5	160
	4	2804.50x30	50	30	57.5	160
	4	2804.60x40	60	40	57.5	160
	4	2804.70x50	70	50	57.5	160
	4	2804.80x60	80	60	57.5	160
	4	2804.100x75	100	75	57.5	160
	5	2805.40x20	40	20	70.5	200
	5	2805.60x40	60	40	70.5	200
	5	2805.70x50	70	50	70.5	200
	5	2805.80x60	80	60	70.5	200
	5	2805.100x75	100	75	70.5	200

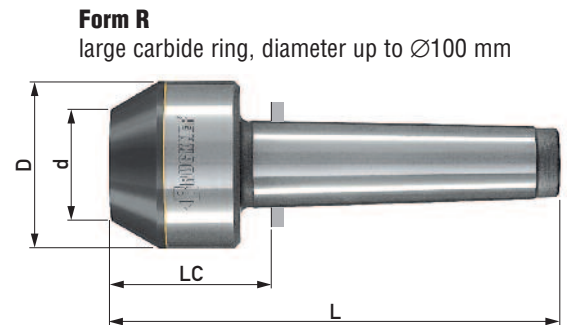

Carbide Dead Centres with 60° Ground Centrebore

Form	Morse taper	ID.No.	B	A	d2	LC	L
B	1	2821	2.8x1.5	6	12.2	23.5	77
	2	2822	4.0x2.0	9	18.0	32	96
	3	2823	5.0x2.5	9	24.1	38	119
	4	2824	6.0x3.0	12	31.6	49.5	152

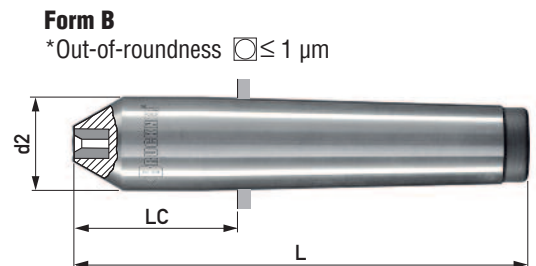

Form	Morse taper	ID.No.	B	A	d2	H	LH	LC	L
HB	1	2831	2.8x1.5	6	12.2	3	19	23.5	77
	2	2832	4.0x2.0	9	18.0	4	26	32	96
	3	2833	5.0x2.5	9	24.1	5	32	38	119
	4	2834	6.0x3.0	12	31.6	5.5	42	49.5	152

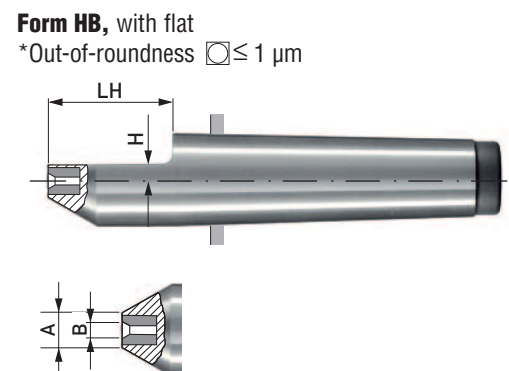

Carbide Dead Centres, Half Centre 60°

without Draw-Off Thread



Form HE – HL – HS – HV

Out-of-roundness $\square \leq 0.8\mu\text{m}$. Morse taper hardened for protection from damage. Quality features see page 54/55.

Form	Morse taper	ID.No.	D	d2	H	LH	LC	L
HE	1	2811H	7	12.2	4	22	26.5	80
	2	2812H	7	18	4	30	36	100
	3	2813H	11	24.1	6	38	44	125
	4	2814H	14	31.6	7.5	50	57.5	160
	5	2815H	18	44.7	9.5	63	70.5	200

Form HE
similar to DIN 806 HE

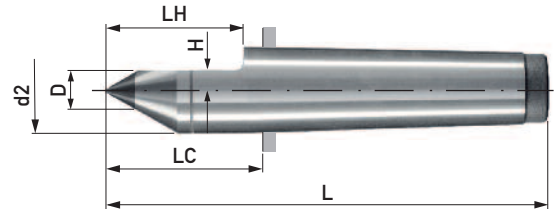

Form	Morse taper	ID.No.	D	d2	H	LH	LC	L
HL	2	2812.11-135	11	18	6	65	71	135
	2	2812.14	14	18	7.5	30	36	100
	3	2813.14	14	24.1	7.5	38	44	125
	3	2813.14-150	14	24.1	7.5	63	69	150
	3	2813.18	18	28	9.5	40	47	128
	4	2814.18	18	31.6	9.5	50	57.5	160
	4	2814.18-180	18	31.6	9.5	70	77.5	180
	4	2814.18-200	18	31.6	9.5	90	97.5	200
	5	2815.18-250	18	44.7	9.5	113	120.5	250

Form HL
larger carbide diameter,
length to DIN and extended

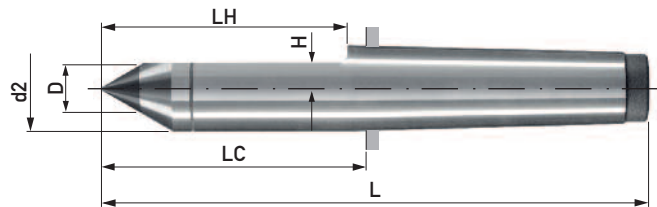

Form	Morse taper	ID.No.	D	d2	H	LH	LC	L
HS	2	2812H/1,5	7	18	1.5	40	46	110
	2	2812H/2,5	7	18	2.5	40	46	110
	3	2813H/1,5	11	24.1	1.5	63	69	150
	3	2813H/2,5	11	24.1	2.5	63	69	150
	3	2813H/4,0	11	24.1	4.0	63	69	150
	4	2814H/1,5	14	31.6	1.5	70	77.5	180
	4	2814H/2,5	14	31.6	2.5	70	77.5	180
	4	2814H/4,0	14	31.6	4.0	70	77.5	180

Form HS
extra flat height, extended

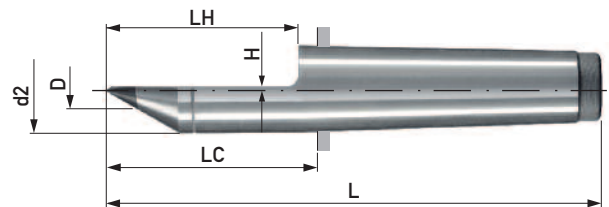

Form	Morse taper	ID.No.	D	H	LH	LC	L
HV	3	2813.24V/H5-150	24.1	5	63	69	150
	3	2813.24V/H7.5-150	24.1	7.5	63	69	150
	4	2814.32V/H5-200	31.6	5	90	97.5	200
	4	2814.32V/H9-200	31.6	9	90	97.5	200

Form HV
extra flat height, solid carbide point with
safety core **sa•co**[®]

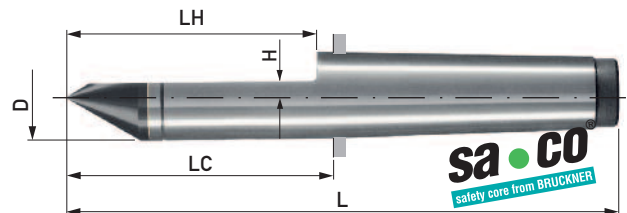

Carbide Dead Centres, Full Centre 60° with Draw-Off Thread

Form GE – GV – GZ – GR

Out-of-roundness $\square \leq 0.8\mu\text{m}$. Morse taper hardened for protection from damage. Quality features see page 54/55.

Form	Morse taper	ID.No.	D	d2	LC	L	G
GE	2	2852	7	18	48	112	M 22x1.5
	3	2853	11	24.1	57	138	M 27x1.5
	3	2853.18	18	24.1	57	138	M 27x1.5
	4	2854	14	31.6	72.5	175	M 36x1.5
	4	2854.18	18	31.6	72.5	175	M 36x1.5
	4	2854.18-200	18	31.6	97.5	200	M 36x1.5
	5	2855	18	44.7	87.5	217	M 48x1.5
	5	2855.18-250	18	44.7	120.5	250	M 48x1.5
	6	2856	18	63.8	108	290	M 68x1.5
	6	2856.35	35	63.8	108	290	M 68x1.5

Form GE
length to DIN and extended

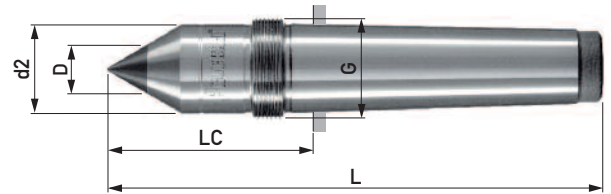

Form	Morse taper	ID.No.	D	LC	L	G
GV	*2	2852.18V	18	48	112	M 22x1.5
	3	2853.24V	24.1	57	138	M 27x1.5
	4	2854.32V	31.6	72.5	175	M 36x1.5
	4	2854.32V-200	31.6	97.5	200	M 36x1.5
	5	2855.45V	44.7	87.5	217	M 48x1.5
	5	2855.45V-250	44.7	120.5	250	M 48x1.5
	**6	2856.64V	63.8	108	290	M 68x1.5

Form GV
solid carbide point
with safety core **sa•co**[®]

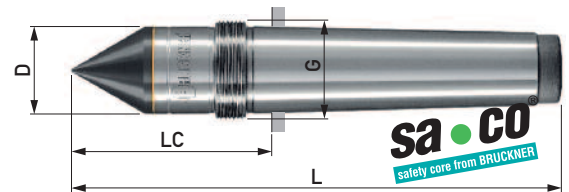

* without safety core, carbide brazed in tapered seating
** without safety core, carbide outer shell with base material core

Form	Morse taper	ID.No.	D	d	d2	LC	L	G
GZ	3	2853.32x10	32	10	38	57	138	M 27x1.5

Form GZ
large carbide insert
with safety core **sa•co**[®]

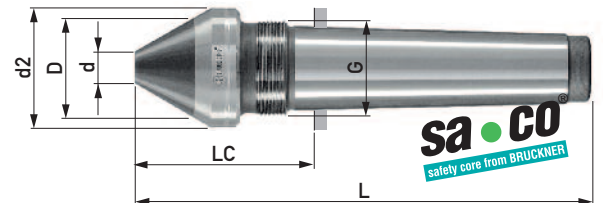

Form	Morse taper	ID.No.	D	d	LC	L	G
GR	3	2853.45x25	45	25	57	138	M 27x1.5
	4	2854.45x25	45	25	72.5	175	M 36x1.5
	4	2854.60x40	60	40	72.5	175	M 36x1.5
	5	2855.45x25	45	25	87.5	217	M 48x1.5
	5	2855.60x40	60	40	87.5	217	M 48x1.5

Form GR
large carbide ring

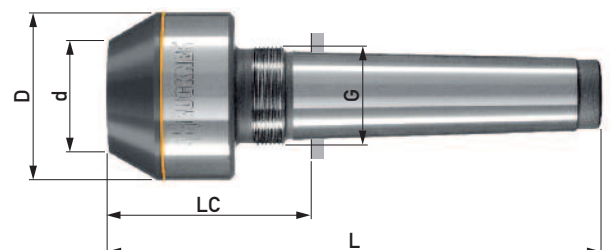

Draw-off nut DIN 807			
ID.No.	G	LM	SW
M252	M 22x1.5	15.5	32
M253	M 27x1.5	17.5	41
M254	M 36x1.5	21	55
M255	M 48x1.5	23	75
M256	M 68x1.5	25.5	100

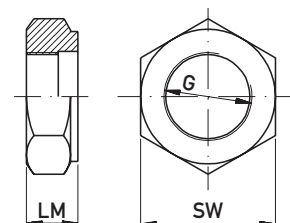

Carbide Dead Centres, Half Centre 60° with Draw-Off Thread

Form GHS – GHV

Out-of-roundness $\square \leq 0.8 \mu\text{m}$. Morse taper hardened for protection from damage. Quality features see page 54/55.

Form	Morse taper	ID.No.	D	d2	H	LH	LC	L	G
GHS	3	2853/4.0-138	14	24.1	4.0	39.5	57.0	138	M 27x1.5
	4	2854/4.0-175	14	31.6	4.0	51.5	72.5	175	M 36x1.5
	4	2854/4.0-200	14	31.6	4.0	76.5	97.5	200	M 36x1.5
	5	2855/6.0-217	18	44.7	6.0	64.5	87.5	217	M 48x1.5
	5	2855/6.0-250	18	44.7	6.0	97.5	120.5	250	M 48x1.5

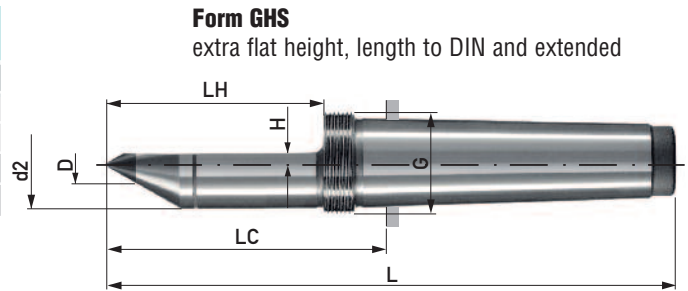

Form GHS
extra flat height, length to DIN and extended

Form	Morse taper	ID.No.	D	H	LH	LC	L	G
GHV	3	2853.24V/H5-150	24.1	5	51.5	69	150	M 27x1.5
	4	2854.32V/H5-200	31.6	5	76.5	97.5	200	M 36x1.5
	4	2854.32V/H9-200	31.6	9	76.5	97.5	200	M 36x1.5

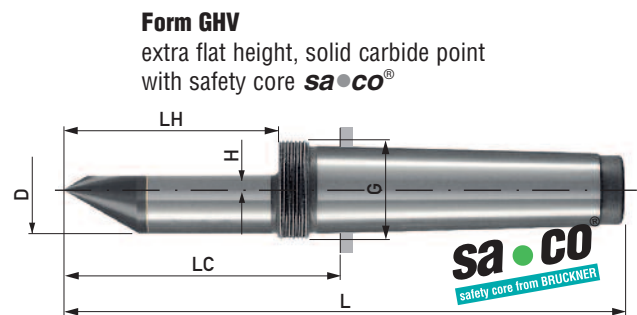

Form GHV
extra flat height, solid carbide point
with safety core **sa•co**[®]

„Roundness achieves roundness“ – Grinding test with standard centres from BRUCKNER

BRUCKNER 2804H in the headstock
Out-of-roundness $\square 0.42 \mu\text{m}$

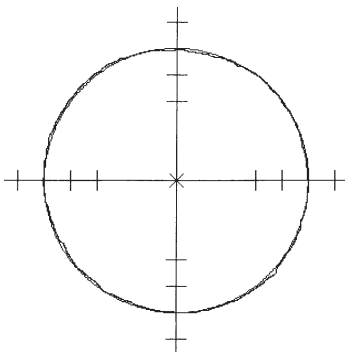

BRUCKNER 2814H in the tailstock
Out-of-roundness $\square 0.48 \mu\text{m}$

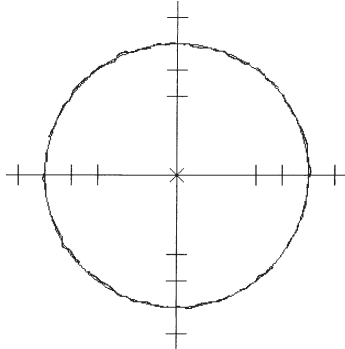

test conditions

cylindrical grinding machine STUDER S33

workpiece 100Cr6, 62 HRC, $\varnothing 35 \text{ mm}$,
un-ground centre DIN 332A

workpiece
out-of-roundness $0.36 \mu\text{m}$

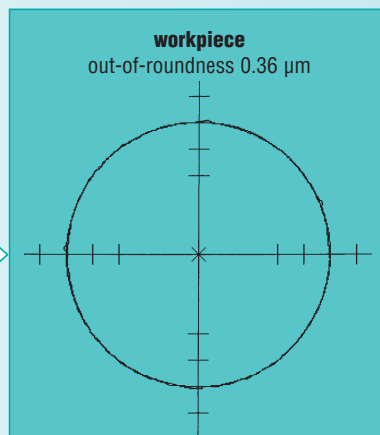

Result:
Out-of-roundness achieved
with standard centres from
BRUCKNER $\square 0.36 \mu\text{m}$.

> INES^H

The interactive system for the generation of enquiry drawings for special designs of carbide dead centres

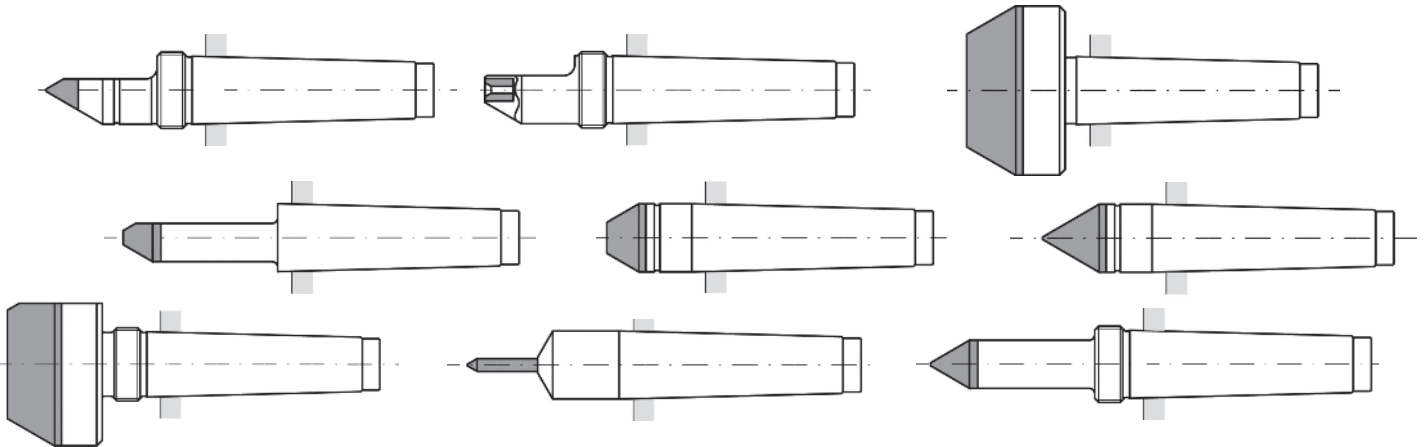

In 4 steps generate your enquiry drawing/s at www.karlbruckner.de/ines

- 1 enter Morse taper size
- 2 determine the basic form
- 3 select the special form
- 4 print the enquiry form and enquiry drawing

Enter the number of pieces in the enquiry form and complete the enquiry drawing/s with dimensions and details.

Send form and drawing to:

Fax **+49(0)71 51/96 71 220** or

E-Mail **ines@karlbruckner.de**

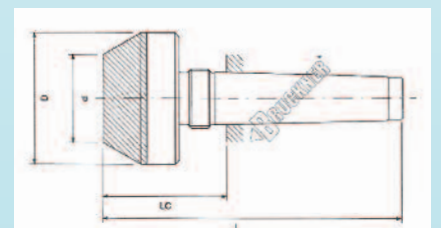
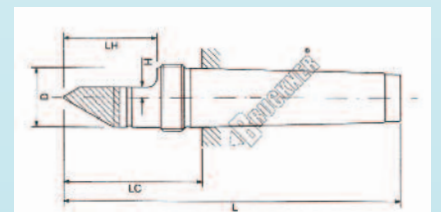
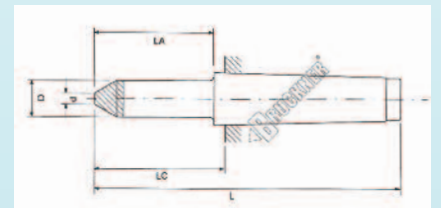

Material

High quality tool steel,
through-hardened

Runout

See table on page 54

Taper shank

Manufactured in gauge accuracy to
DIN 228 \leq AT4. This means a precise
seating of the centre in the tailstock sleeve
(see table on page 54)

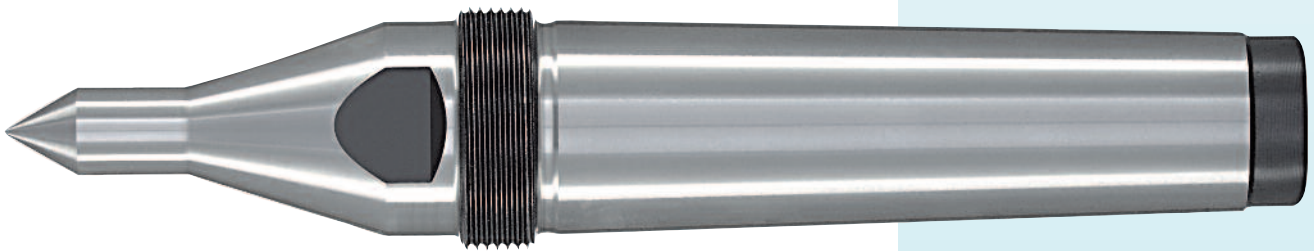

The quick solution – systematically

The use of BRUCKNER centres for revolving tailstock sleeves enables a flexible reaction to changing workpiece forms and turning operations.

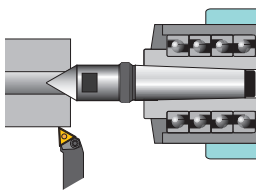

Form 255
for small and large centrebores

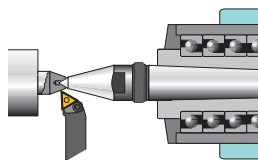

Form 256
for limited work space

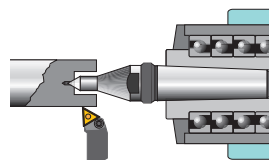

Form 257
for threading and for centrebores
deep inside a workpiece

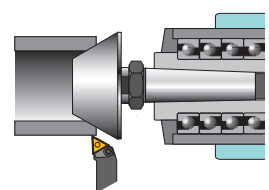

Form 258
for large centrebores

Tool Steel Dead Centres with Draw-Off Thread

Morse taper, metr. 80 1:20, taper 80 1:10

Form 255 – 256 – 257 – 258

Interchangeable dead centres, through-hardened for revolving tailstock sleeves

Form	Taper size	ID.No.	D	G	SW	LC	L	Draw-off nut
255	MT 2	2552	18	M 22x1.5	16	48	112	M252
		2553	24.1	M 27x1.5	22	57	138	M253
	MT 3	2553-150	24.1	M 27x1.5	22	69	150	M253
		2553-170	24.1	M 27x1.5	22	89	170	M253
	MT 4	2554	31.6	M 36x1.5	27	72.5	175	M254
		2554-190	31.6	M 36x1.5	27	87.5	190	M254
		2554-230	31.6	M 36x1.5	27	127.5	230	M254
	MT 5	2555	44.7	M 48x1.5	41	87.5	217	M255
		2555-250	44.7	M 48x1.5	41	120.5	250	M255
	MT 6	2556	63.8	M 68x1.5	55	108	290	M256
Metr. 80 1:20	2557.20	80	M 85x2	-	134	330	M257	
Taper 80 1:10	2557.10	80	M 85x2	-	130	330	M257	

Form	Taper size	ID.No.	D	d2	G	SW	LC	L	Draw-off nut
256	MT 2	2562	6	18	M 22x1.5	16	48	112	M252
	MT 3	2563	8	24.1	M 27x1.5	22	57	138	M253
	MT 4	2564	10	31.6	M 36x1.5	27	72.5	175	M254
	MT 5	2565	12	44.7	M 48x1.5	41	87.5	217	M255
	MT 6	2566	15	63.8	M 68x1.5	55	136	318	M256

Form	Taper size	ID.No.	D	d2	G	SW	LA	LC	L	Draw-off nut
257	MT 2	2572.06-120	6	18	M 22x1.5	16	15	56	120	M252
		2572.09-120	9	18	M 22x1.5	16	17	56	120	M252
		2572.11-120	11	18	M 22x1.5	16	21	56	120	M252
	MT 3	2573.09-150	9	24.1	M 27x1.5	19	17	69	150	M253
		2573.13-150	13	24.1	M 27x1.5	19	25	69	150	M253
		2574.09-190	9	31.6	M 36x1.5	27	17	87.5	190	M254
	MT 4	2574.13-190	13	31.6	M 36x1.5	27	27	87.5	190	M254
		2574.19-190	19	31.6	M 36x1.5	27	53	87.5	190	M254

Form	Taper size	ID.No.	D	d	G	SW	LC	L	Draw-off nut
258	MT 2	2582.40	40	1	M 22x1.5	36	64	128	M252
		2582.80x20	80	20	M 22x1.5	36	88	152	M252
	MT 3	2583.40	40	1	M 27x1.5	36	65	146	M253
		2583.80x20	80	20	M 27x1.5	36	89	170	M253
	MT 4	2584.80x20	80	20	M 36x1.5	36	89.5	192	M254
		2584.125x65	125	65	M 36x1.5	36	89.5	192	M254
		2585.80x20	80	20	M 48x1.5	50	100.5	230	M255
	MT 5	2585.100x50	100	50	M 48x1.5	50	90.5	220	M255
		2585.125x65	125	65	M 48x1.5	50	100.5	230	M255

Draw-off nut to DIN 807			
ID.No.	G	LM	SW
M252	M 22x1.5	15.5	32
M253	M 27x1.5	17.5	41
M254	M 36x1.5	21	55
M255	M 48x1.5	23	75
M256	M 68x1.5	25.5	100
M257	M 85x2.0	40	130

Form 255
similar to DIN 807 and extended

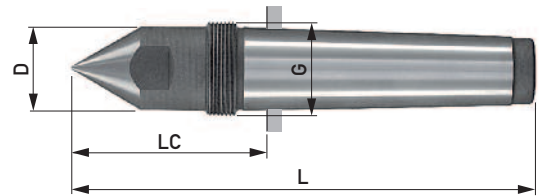

Form 256
copying centre 60°/40°

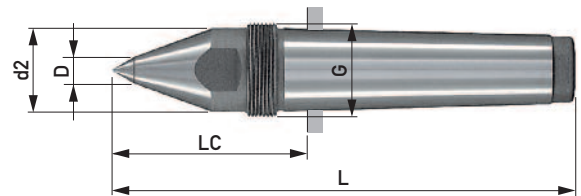

Form 257
slim design 60°/30°

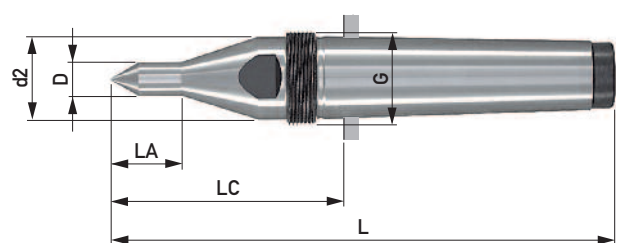

Form 258
bullnose dead centre 60°

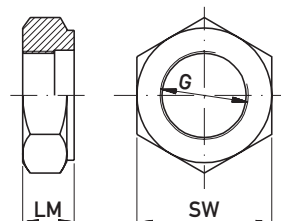
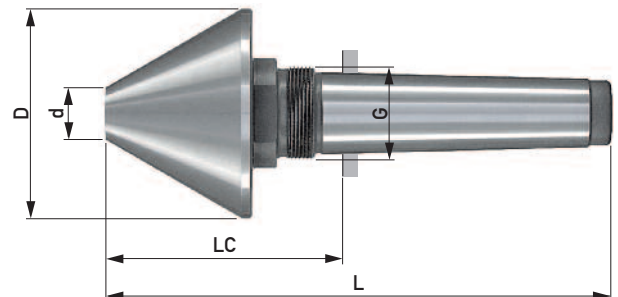

Tool Steel Dead Centres without Draw-Off Thread

Morse taper, metr. 80 1:20, taper 80 1:10



Form 250

Dead centres – to DIN 806 – through-hardened

Form	Taper size	ID.No.	D	LC	L
250	MT 0	2500	9.2	20.0	70
	MT 1	2501	12.2	26.5	80
	MT 2	2502	18.0	36.0	100
	MT 3	2503	24.1	44.0	125
	MT 4	2504	31.6	57.5	160
	MT 5	2505	44.7	70.5	200
	MT 6	2506	63.8	88.0	270
	Metr. 80 1:20	2507.20	80.4	124.0	320
	Taper 80 1:10	2507.10	80.8	120.0	320

Form 250
to DIN 806, full centre 60°

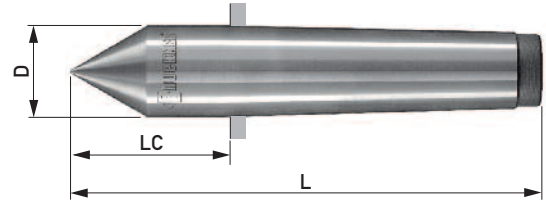

Tool Steel Dead Centres – Special Designs

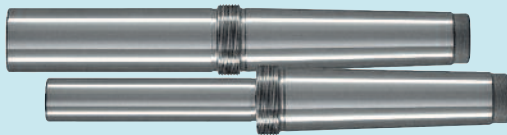

setting mandrels

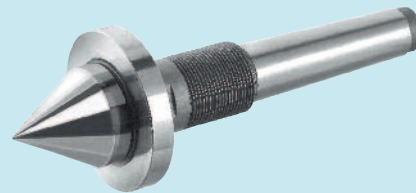

centre with measuring bands

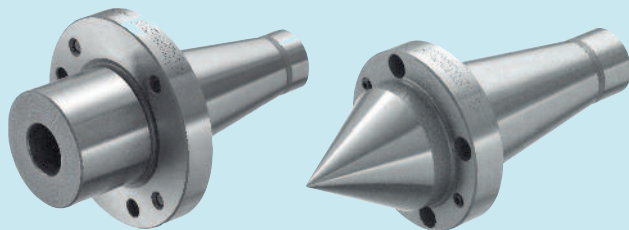

SK 45 with face contact
cylindrical mounting for caps

60° centre



extension sleeve MT 5 to MT 5



double diameter 60° dead centre
with draw-off thread



bullnose dead centre with SK 30 mounting taper

Tool Steel Dead Centres

Steep tapers SK 30, SK 40



Form 220 – 230

Interchangeable dead centres, through-hardened, runout max. 0.004 mm, for revolving tailstock sleeves

Taper form	Steep taper	Group	ID.No.	D	d	d2	LC	LA	L	
220 is suitable for Index	30	A	2230.10 A-130	10		32.5	61.6		130	
			2230.10 A-150	10		32.5	81.6		150	
		B	2230.09 B-120	9		32.5	51.6	17	120	
			2230.13 B-125	13		32.5	56.6	27	125	
			2230.19 B-135	19		32.5	66.6	57	135	
			2230.25 B-145	25		32.5	76.6	67	145	
		C	2230.36 C-116	36				47.6		116
			2230.36 C-130	36				61.6		130
		D	2230.80x20 D	80	20			71.6		140
			2230.125x65 D	125	65			71.6		140
40	C	2240.48 C-152	48			59		152		
230 is suitable for MAG (Boehringer)	30	A	2330.10 A-130	10		32.2	61.6		130	
			2330.10 A-150	10		32.2	81.6		150	
			2330.10 A-170	10		32.2	101.6		170	
		B	2330.09 B-120	9		32.2	51.6	17	120	
			2330.09 B-150	9		32.2	81.6	17	150	
			2330.13 B-125	13		32.2	56.6	27	125	
			2330.13 B-170	13		32.2	101.6	27	170	
			2330.19 B-135	19		32.2	66.6	50	135	
			2330.19 B-170	19		32.2	101.6	50	170	
			2330.25 B-145	25		32.2	76.6	63	145	
		C	2330.32 C-116	32.2				47.6		116
			2330.32 C-130	32.2				61.6		130
			2330.32 C-150	32.2				81.6		150
			2330.32 C-170	32.2				101.6		170
			2330.45 C-130	45				61.6		130
		D	2330.80x20 D	80	20			71.6		140
			2330.125x65 D	125	65			71.6		140
		40	C	2340.44 C-152	44.9			58.6		152
				2340.44 C-172	44.9			78.6		172
				2340.44 C-200	44.9			106.6		200

Form 220
is suitable for Index

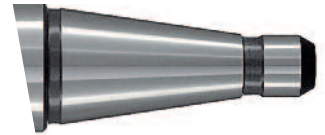

Form 230
is suitable for MAG (Boehringer)

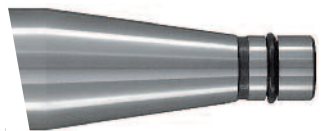

We make special forms, larger steep tapers or carbide-tipped designs to your requirements.

Group A – Copying centre 60°/30°

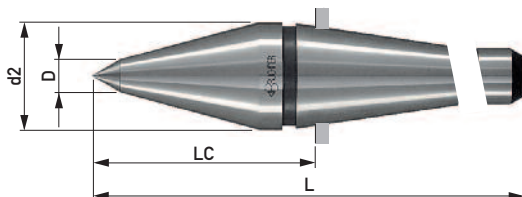

Group B – Slim centre 60°

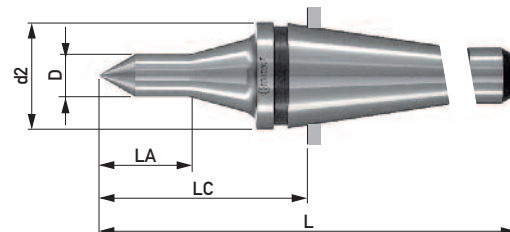

Group C – Full centre 60°

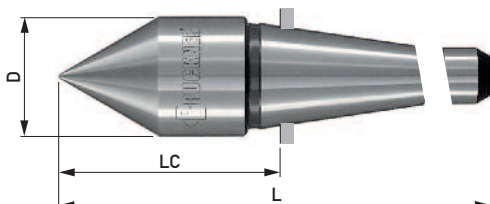

Group D – Bullnose dead centre 60°



Adapter sleeve Type KE

With internal taper 1:7.5
 Made from alloy case-hardening steel,
 hardened, with draw-off thread,
 internally and externally precision-ground

Runout
 max. 0.003 mm

Application
 For regrinding interchangeable inserts.
 Combined with the inserts (page 15)
 use as a dead centre in the headstock
 and tailstock for special applications.

► Draw-off nut to DIN 807, see page 59

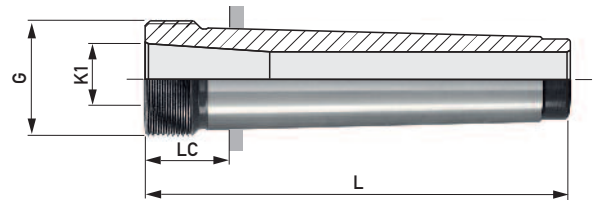

Morse taper	Type KE ID.No.	Draw-off nut	K1	G	LC	L	Insert size (page 15)
2	2952A	M252	11	M 22x1.5	16	80	482..
3	2953A	M253	15	M 27x1.5	21	102	484..
4	2954A	M254	22	M 36x1.5	25.5	128	487..
5	2955A	M255	28	M 48x1.5	30.5	160	485..

Reduction sleeve Type SPHA

of alloy case-hardening steel, hardened,
 with draw-off thread, internally and externally
 precision-ground

Runout
 Max. 0.003 mm

► Draw-off nut to DIN 807, see page 59

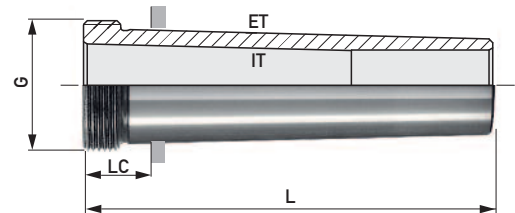

Taper size		Type SPHA				
external	internal	ID.No.	Draw-off nut ID.No.	LC	G	L
ET	IT					
MT 3	MT 2	6032A	M253	17.5	M 27x1.5	91.5
MT 4	MT 2	6042A	M254	16.5	M 36x1.5	110
	MT 3	6043A	M254	16.5	M 36x1.5	110
MT 5	MT 2	6052A	M255	16.5	M 48x1.5	132
	MT 3	6053A	M255	16.5	M 48x1.5	132
	MT 4	6054A	M255	16.5	M 48x1.5	132
MT 6	MT 4	6064A	M256	21.5	M 68x1.5	166
	MT 5	6065A	M256	21.5	M 68x1.5	166
Metr. 80 1:20	MT 5	6805A	M80*	20	M 80x2	192
	MT 6	6806A	M80*	20	M 80x2	192
Taper 80 1:10	MT 6	6806.1A	M80*	20	M 80x2	192

*Similar to DIN 1804

CARBIDOR® features

Permanent connection with the carrier material, impact resistant

High hardness 74 – 78 HRC

Surface roughness:

CARBIDOR®-F Rz 15 µm

CARBIDOR®-M Rz 17 µm

CARBIDOR®-G Rz 19 µm

Coating thickness approx. 25 µm

In case of wear recoating is possible.



CARBIDOR® coated tool steel dead centres for gear cutting, fine turning, finishing, measuring/inspection

CARBIDOR®

is tungsten carbide based coating especially developed to drive workpieces. The coating can be applied to all hard tool steels and particularly features wear resistance, high coefficient of friction and low coating thickness.

CARBIDOR® is applied to enhance friction between workpiece and clamping tool. In this case almost all shapes can be coated. To drive by a workpiece centre, the centre must be $\geq 4 \times 2$ mm. The axial pressure should be as high as possible.

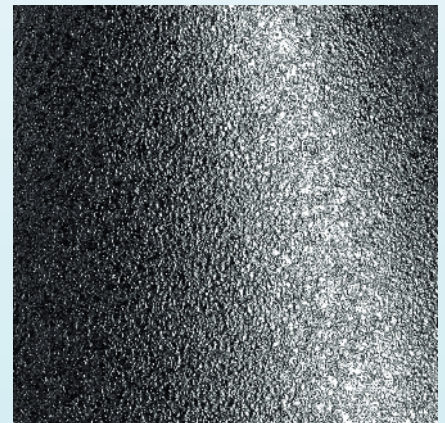

CARBIDOR® surface structure

CARBIDOR® coating is applicable to

- ▶ BRUCKNER standard tool steel dead centres (pages 63 – 65)
- ▶ tool steel dead centres in special design
- ▶ all soft, hardened components of tool steel and stainless steel, jaws, spheres, collets etc.

Please pay attention to our safety tips for process reliability of driving coatings.

www.karlbruckner.de/prse

Tool Steel Dead Centres with CARBIDOR®-M Coating



Form 250CA – 255CA – 257CA – 258CA



Form	MT	ID.No.	D	LC	L
250CA	2	2502CA	18.0	36.0	100
	3	2503CA	24.1	44.0	125
	4	2504CA	31.6	57.5	160

Form 250CA
full centre 60°, without draw-off thread

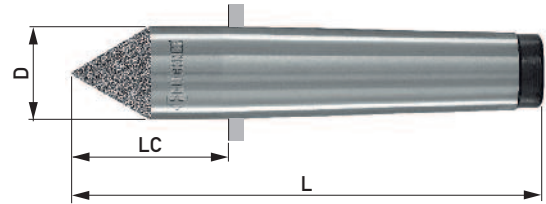

Form	MT	ID.No.	D	G	SW	LC	L	Draw-off nut
255CA	2	2552CA	18.0	M22x1.5	16	48	112	M252
	3	2553CA	24.1	M27x1.5	22	57	138	M253
	4	2554CA	31.6	M36x1.5	27	72.5	175	M254

Form 255CA
full centre 60°, with draw-off thread

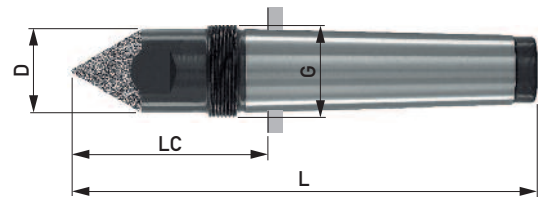

Form	MT	ID.No.	D	d2	G	SW	LA	LC	L	Draw-off nut
257CA	2	2572.06-120CA	6	18	M22x1.5	16	15	56	120	M252
	2	2572.09-120CA	9	18	M22x1.5	16	17	56	120	M252
	2	2572.11-120CA	11	18	M22x1.5	16	21	56	120	M252
	3	2573.09-150CA	9	24.1	M27x1.5	19	17	69	150	M253
	3	2573.13-150CA	13	24.1	M27x1.5	19	25	69	150	M253
	4	2574.09-190CA	9	31.6	M36x1.5	27	17	87.5	190	M254
	4	2574.13-190CA	13	31.6	M36x1.5	27	27	87.5	190	M254
	4	2574.19-190CA	19	31.6	M36x1.5	27	53	87.5	190	M254

Form 257CA
slim centre 60°/30°, with draw-off thread

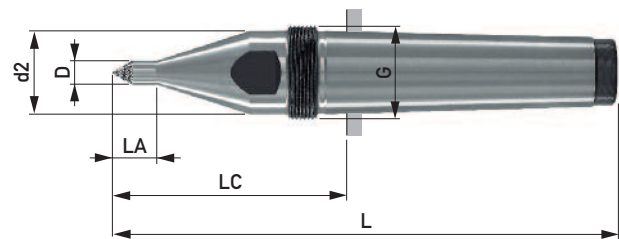

Form	MT	ID.No.	D	G	SW	LC	L	Draw-off nut
258CA	2	2582.40CA	40	M22x1.5	36	64	128	M252
	3	2583.40CA	40	M27x1.5	36	65	146	M253

Form 258CA
bullnose dead centre 60°, with draw-off thread

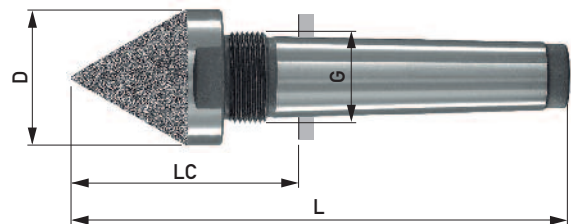

Draw-off nut to DIN 807			
ID.No.	G	LM	SW
M252	M 22x1.5	15.5	32
M253	M 27x1.5	17.5	41
M254	M 36x1.5	21	55

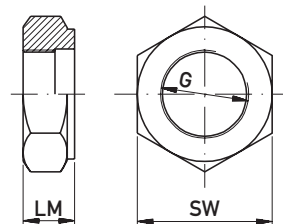

Please pay attention to our safety tips for process reliability of driving coatings: www.karlbruckner.de/prse

for hard turning

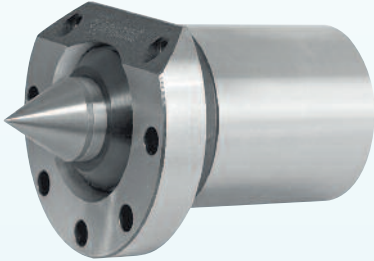

for vertical turning machines

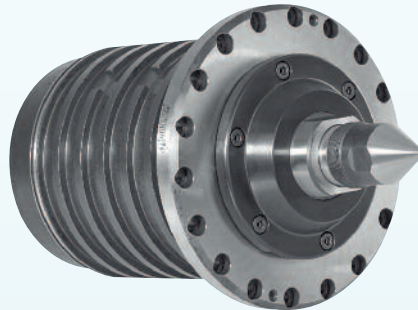

with internal taper 1:7.5 for interchangeable inserts

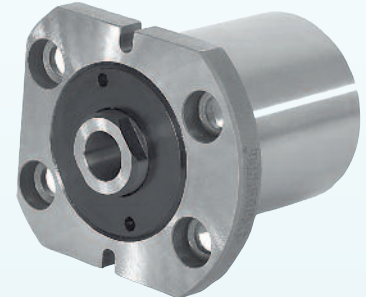

with spring and coloured pressure indication



High Performance Bullnose Live Centres Special Designs

for mounting chucks



pointed design



with carbide cap and flange mounting



with carbide triple contact pads



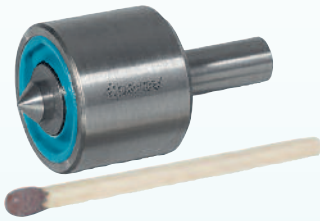

from small to large

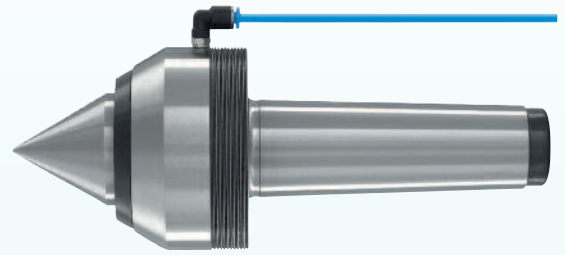
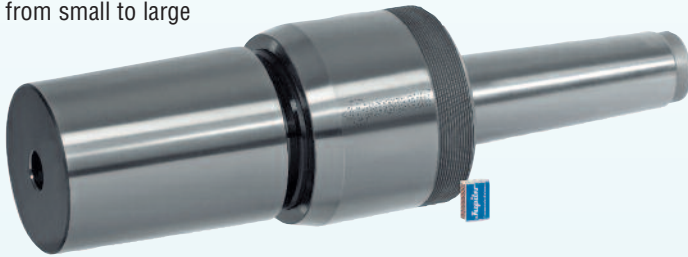

with sealing air connection



HSK40

Capto4

ABS50



large centrepoint



carbide spherical centre



live collet chuck



flange mounted centres, flat and full



flange mounted carbide centres with flat and full carbide



12° driving ring



Ø 52 carbide ball



Ø 20



steep taper with full carbide



HSK with full carbide



open centre bore with Morse taper mounting

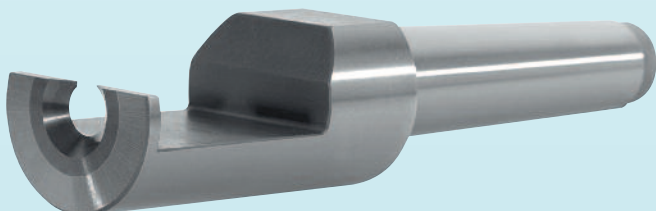



Karl Bruckner GmbH
Präzisionswerkzeugfabrik

P.O. Box 3146
71373 WEINSTADT
GERMANY
Bruckwiesenstrasse 13
71384 WEINSTADT
GERMANY

Phone +49 (0) 7151 9671-0
Fax +49 (0) 7151 9671-23
info@karlbruckner.de
www.karlbruckner.de

> ...also in our programm

HS Face Drivers
with hydraulic compensation

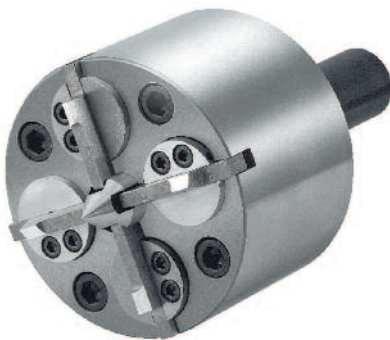

SM Face Drivers
with mechanical compensation



Work Drivers

